

ANTEPRIMA  
**CATALOGO**



*Enjoy*  
**THE  
EXPERIENCE**

**Plastic free Packaging**  
Il nostro impegno

**Equiframe**  
La sicurezza innanzitutto

**Perfect for vans**  
Il più compatto possibile

OUTDOOR | CAMPING | ON THE ROAD

# DEALER WORKBOOK 2023

Siamo convinti che i momenti trascorsi insieme all'aria aperta siano quelli che durano tutta la vita. Che si tratti di prendere il sole in spiaggia, di trascorrere un bel pomeriggio in bicicletta o di fare un barbecue con gli amici camperisti la sera, le ore e i giorni trascorsi all'aria aperta rappresentano alcuni dei ricordi più preziosi.

Ecco perché, anno dopo anno, il nostro team sviluppa nuovi prodotti outdoor che catturano questi momenti di felicità. Con una mentalità mirata e una passione per le soluzioni funzionali e pratiche, il nostro obiettivo è quello di creare accessori fantastici che migliorino la vostra esperienza all'aria aperta.

Combinando il design italiano con il know-how produttivo in diversi Paesi del mondo, siamo in grado di sviluppare, presentare e produrre nuovi prodotti outdoor in modo continuo. Prodotti che apprezzerete fin da subito e per molto tempo.

Con passione dall'Alto Adige al resto del mondo e viceversa,

Il vostro team Brunner Outdoor

















*Team Brunner*



# CATALOGUE PREVIEW

## CONTENT



1		INTRO .....	2
2		TENTS .....	8
3		GAZEBOS & BEACH PARASOLS .....	96
4		CAMPING ACCESSORIES .....	106
5		FLOOR & DOOR .....	124
6		LAMPS & LANTERNS .....	138
7		SLEEP & RELAX .....	144
8		TRAVEL ACCESSORIES .....	164
9		OUTDOOR FURNITURE .....	170
10		TABLE & KITCHEN .....	236
11		GAS ITEMS .....	318
12		HOUSEHOLD .....	328
13		COOLING .....	342
14		ELETRICAL PRODUCTS .....	354
15		WATER & SANITATION .....	376
16		TECHNIQUE .....	386
17		DISPLAY BOX .....	422



# MIX & MATCH

Coordina per forma e colore

Arreda in modo accogliente il tuo ambiente Outdoor e donagli un tocco di lusso. La vastità di colori e forme dei prodotti presenti nel catalogo Brunner rendono possibile un allestimento del tutto individuale senza rinunciare però alla fantastica armonizzazione di prodotti di diverse categorie merceologiche.

Createvi il vostro ambiente personale - come a casa vostra!



ARAVEL 3D  
p. 176



MERCURY CROSS  
COOKER HWT SQUARE  
p. 229



CAMPERKING  
p. 218



POLARYS  
TRAVEL  
p. 348

# ENJOY THE EXPERIENCE



Tre parole speciali che hanno un significato differente per ogni persona che le legge. Ispirati dal bisogno delle persone a muoversi, abbiamo speso decenni a inventare, re-inventare e ottimizzare equipaggiamenti utili per tutti coloro che amano spendere il loro tempo libero in qualsiasi tipo di attività outdoor. Questo ci ha portati a realizzare una gamma di prodotti di alta qualità adatti per adeguarsi ai vostri bisogni e assicurare soddisfazione indipendentemente dai luoghi, dal clima e dalle condizioni meteorologiche. Combinando design e funzionalità realizziamo prodotti che rendono la vita outdoor un'esperienza emozionante senza fine.





# INNOVATIONS



## NUOVO O INNOVATIVO?

L'INNOVAZIONE ISPIRA E STIMOLA LA RICERCA DEL NUOVO.

**Il nuovo, che aiuta l'uomo a rendere la propria vita più semplice, più confortevole e più sicura. L'innovazione è l'impulso che incita e ispira la ricerca, che la colma di capacità e saggezza.**

L'acquisto di una nuova attrezzatura è un'importante decisione fatta sulla base di vari fattori come funzionalità, design, qualità, lavorazione ed il rapporto qualità/prezzo. Anche quest'anno il catalogo Brunner Outdoor 2023 propone una varietà di novità nei vari settori. Una varietà che aspetta di essere scoperta, provata e combinata per forme e colori. Sfogliate comodamente il catalogo oppure visitate il catalogo online, per trovare prodotto e prezzo più adatti alle vostre esigenze.

## QUADRA COMPACT 2023 ORIGINAL DESIGN & ENGINEERING



originaldesign



## PLASTIC FREE

Brunner Outdoor vuole essere in prima linea nell'impegno verso un mondo più pulito. È per questo che siamo orgogliosi di aver dato inizio ad un processo che nell'arco di 3-5 anni porterà ad un azzeramento del packaging commerciale realizzato in materiale plastico. Questo processo che, oltre a portare benefici concreti, si pone l'obiettivo di ulteriormente sensibilizzare la cultura del rispetto per il nostro pianeta di tutti gli amanti Outdoor, peraltro già particolarmente sensibili a questa tematica.



## OUR PATENTS

I NOSTRI BREVETTI

**I brevetti sono rappresentativi dell'inventiva e della voglia di innovazione di un'azienda e indubbiamente utilissimi per migliorare la prestazione dei prodotti.**

Alcuni dei nostri articoli, come ad esempio le popote con sistema Magnetogrip, che definiscono un nuovo standard funzionale e offrono ai camperisti il massimo comfort in termini di utilizzo, sono stati brevettati in vari paesi con lo scopo di proteggere la nostra esperienza e conoscenza.



MAGNETO GRIP

# IMPROVEMENTS



Il continuo sviluppo  
e l'ottimizzazione  
dei nostri prodotti rende  
**L'ESPERIENZA  
OUTDOOR  
SICURA E  
CONFORTEVOLE**



## UTILIZZO SICURO

La sicurezza del consumatore finale è un elemento fondamentale della politica prodotti Brunner.

### ALCUNI ESEMPI:

- Il rispetto della normativa Reach
- Il rispetto della certificazione CE
- Tessuti ignifughi
- L'utilizzo di meccaniche anti-infortunistiche
- Collaudi TÜV/GS



⟨M⟩  
mountless

OUR SYSTEMS

Goditi l'installazione rapida e senza problemi della tua attrezzatura Outdoor grazie ai nostri eccezionali sistemi MOUNTLESS.

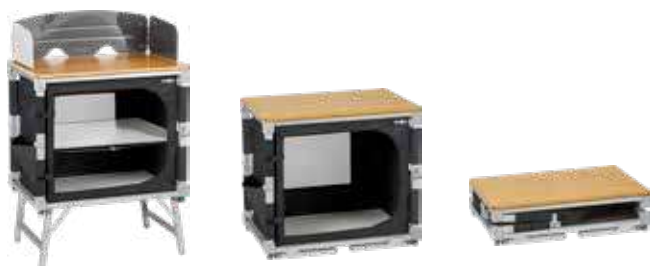

⟨O⟩  
oneflate

OUR SYSTEMS

Le tende e i gazebo A.I.R.Tech con tecnologia ONEFLATE dispongono di camere d'aria interconnesse, gonfiabili tramite una sola valvola di ingresso dell'aria.





# USED ICONS

Misure aperto	Misure chiuso	Misure	Peso
Portata	Tessuto	Sopratelo	Abitacolo
			$\Delta t$
Catino	Misure abitacolo	Struttura	Differenziale termico
Paleria interna	Paleria esterna	Colonna d'acqua	Cuciture sigillate
$l/min$			
Litri al minuto	Usò alimentare	Temperatura	Strati
Imbottitura	Custodia	Tessuto interno	Tessuto esterno
<b>P</b>	<b>V</b>		<b>alu</b>
Potenza	Volume	Funzionamento	Alluminio
<b>steel</b>	<b>alu hybrid</b>	<b>p</b>	
Acciaio	Alluminio / Acciaio	Pressione	Tempo / durata
Attacco gas	LED	Lumen	Autonomia batteria



# USED EXPLICATIVE LOGOS





# WEB SUPPORT



## SCOPRI IL NUOVO SITO BRUNNER E IMPARA A CONOSCERE LE IDEE CHE STANNO DIETRO AI NOSTRI PRODOTTI

**Un sacco di idee ed innovazioni che rivoluzionano l'avventura Outdoor ed un sacco di informazioni sulla gamma di prodotti Brunner.**

Lasciati ispirare e metti insieme la tua attrezzatura in modo tale che soddisfi le tue esigenze e le tue aspettative. Resterai sorpreso dalla moltitudine di nuovi prodotti, dalle ottimizzazioni e dalle tante piccole migliorie, perché sono sempre i dettagli che fanno la differenza.

**Web Site**  
brunneroutdoor.com  
**QR code**



# MARKETING SUPPORT

## CON IL NOSTRO SUPPORTO MARKETING TRASPARENTE ED EFFICACE, VI FORNIAMO UN SOSTEGNO VERSATILE PER LE VOSTRE ATTIVITÀ DI VENDITA ONLINE E OFFLINE.

Utilizzate il know-how del nostro team di marketing e pubblicità per i vostri progetti. Parallelamente, la nostra ampia gamma di risorse di marketing, come immagini, video, reel e prodotti POS, è a vostra disposizione.

Vi aiutiamo a fondere gli obiettivi commerciali e di marketing.





# TENTS

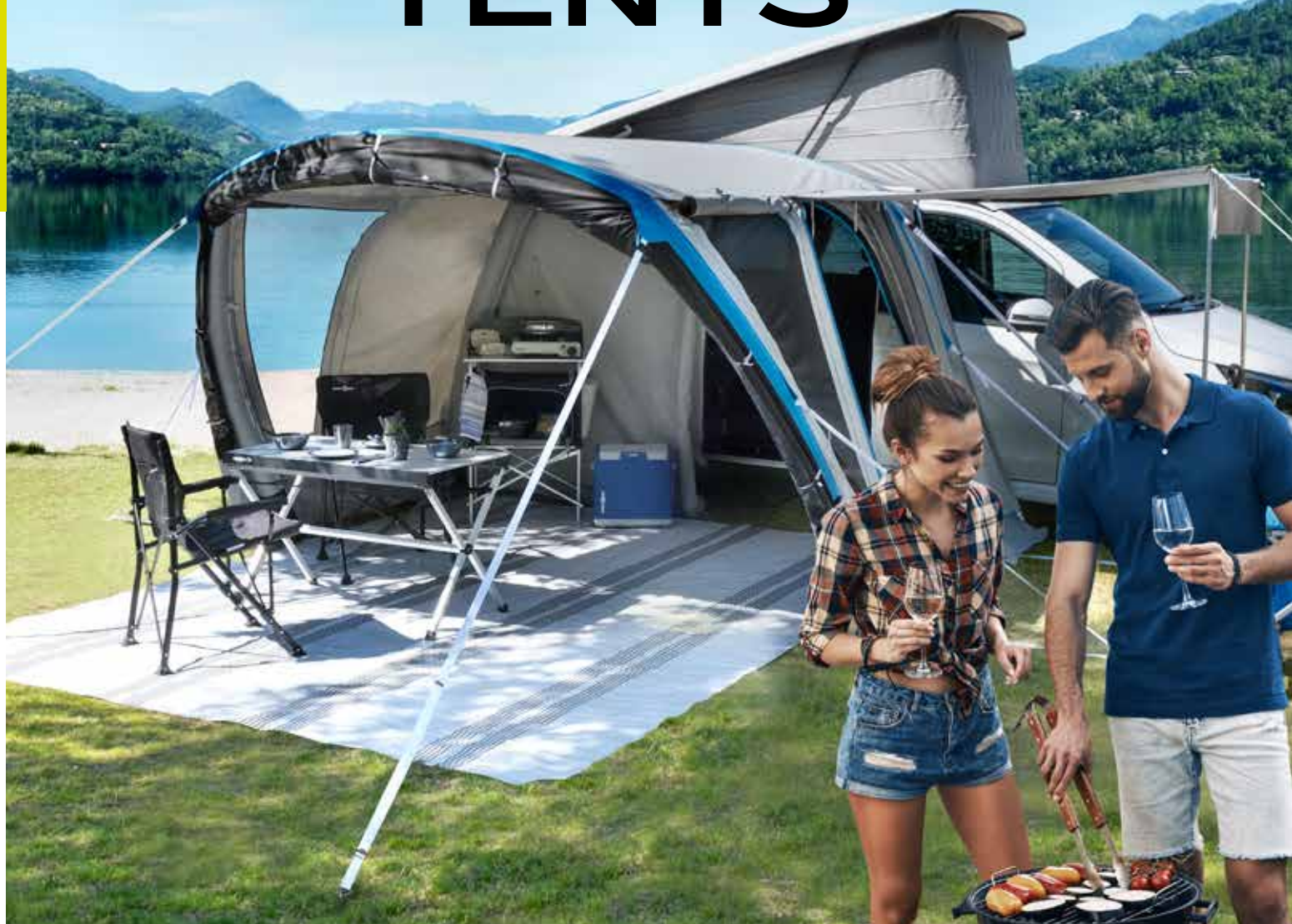

## LA TENDA MODERNA IN TUTTE LE SUE VARIANTI

**La tenda rappresenta un'importante interfaccia dell'uomo con l'ambiente circostante, essa gioca un ruolo decisivo sullo stato del benessere degli occupanti durante il periodo del suo utilizzo. Già un modello Family medio garantisce un livello di comfort impensabile fino a pochi anni fa. Comfort che è diventato un elemento decisivo per l'apprezzamento ed il successo stesso del prodotto e che si caratterizza per:**

- Materiali utilizzati
- Spazio interno, utilizzabile anche in caso di cattivo tempo
- Spazio per cucinare
- Velocità di montaggio
- Dotazioni comfort di serie (catino incernierato, entrate cavi elettrici, nastri fissacavi, tettiucci parapiovra, ecc.)
- Peso





## PANORAMICA MODELLI TENDE

- P. 22-27**      Tende Family A.I.R.Tech in policotone
- P. 28-33**      Tende Family A.I.R.Tech in poliestere
- P. 34-37**      Tende Family classiche in poliestere
- P. 38-39**      Tende Touring in poliestere
- P. 40-41**      Tende Automatic in poliestere
- P. 42-49**      Tende Minibus A.I.R.Tech in policotone
- P. 50-51**      Verande Caravan A.I.R.Tech in policotone
- P. 52-53**      Tettucci Parasole A.I.R.Tech in policotone
- P. 54-59**      Tende Minibus A.I.R.Tech in poliestere
- P. 60**          Verande Caravan A.I.R.Tech in poliestere
- P. 61**          Tettucci parasole A.I.R.Tech in poliestere
- P. 62-66**      Tende Minibus classiche in poliestere
- P. 67-71**      Tende posteriori in poliestere
- P. 72-75**      Tettucci parasole in poliestere / politene
- P. 76-77**      Tettucci parasole Caravan in policotone / poliestere
- P. 80-87**      Cucinotti e tende storage
- P. 88-91**      Gazebi Outdoor
- P. 92-93**      Conchiglie parasole
- P. 94-95**      Paravento







MAISONEL 4  
P. 24



PURE 4  
P. 26



MANSION 3  
P. 30



PARAISO 5/6  
P. 32

TIPO MONTAGGIO

PRIMA SOPRATELO

Numero persone	4	4	3	5
Altezza cm	220	210	210	215
Tessuto sopratelo	Polycotton	Polycotton	Oxford Polyester	Oxford Polyester
Colonna d'acqua mm	-	-	3000	3000
Spalmatura	-	-	PU	PU
Nastratura sopratelo	-	-	-	•
Apertura aerazione	•	•	•	•
Balza perimetrale	•	•	•	-
Tessuto abitacolo	Poliestere traspirante	Poliestere traspirante	Poliestere traspirante	Poliestere traspirante
Abitacolo Creanox	•	•	•	•
Divisorio abitacolo	•	•	•	•
Paleria	Airtube	Airtube	Airtube	Airtube
Paleria precollegata	-	-	-	-
Paleria con segnalini colorati	-	-	-	-
Fissaggio paleria Ring-Pin	•	•	•	-
Regolazione punti di ancoraggio	•	•	•	•
Pali verticali veranda	•	•	•	•
Numero entrate	2	2	2	2
Finestre Airama	-	•	-	-
Finestre Panorama	•	•	•	•
Stuoia veranda	-	-	-	-
Catino cucito a chiusura totale	•	•	•	•
Zanzariera entrata abitacolo	•	•	•	•
Zanzariera ingressi	•	•	•	•
Ingresso cavo sopratelo	•	•	•	•
Ingresso cavo abitacolo	•	•	•	•
Rinforzi punti max. sollecitazione	•	•	•	•
Tasche interne	•	•	•	•
Gancio appendilampada	•	•	•	•
Corde tensione prefissate	•	•	•	•
Corde tensione riflettenti	•	•	•	•
Accessori di montaggio	•	•	•	•
Sacca custodia	•	•	•	•



CAPRICE 5  
P. 34



KALYNDA 5  
P. 36



ARQUS 5  
P. 37

TIPO MONTAGGIO

PRIMA SOPRATELO

Numero persone	5	5	5
Altezza cm	205	205	205
Tessuto sopratelo	Oxford Polyester	150D Polyester	68D Polyester
Colonna d'acqua mm	3000	3000	3000
Spalmatura	PU	PU	PU
Nastratura sopratelo	•	•	•
Apertura aerazione	•	•	-
Balza perimetrale	•	-	-
Tessuto abitacolo	Poliestere traspirante	Poliestere traspirante	Poliestere traspirante
Abitacolo Creanox	•	•	•
Divisorio abitacolo	•	•	•
Paleria	Fiberglass	Fiberglass	Fiberglass
Paleria precollegata	•	•	•
Paleria con segnalini colorati	•	•	•
Fissaggio paleria Ring-Pin	•	•	•
Regolazione punti di ancoraggio	•	•	•
Pali verticali veranda	-	•	•
Numero entrate	2	1	3
Finestre Airama	-	•	•
Finestre Panorama	•	•	-
Stuoia veranda	-	-	-
Catino cucito a chiusura totale	•	•	•
Zanzariera entrata abitacolo	•	•	•
Zanzariera ingressi	•	•	•
Ingresso cavo sopratelo	•	•	•
Ingresso cavo abitacolo	•	•	•
Rinforzi punti max. sollecitazione	•	•	•
Tasche interne	•	•	•
Gancio appendilampada	•	•	•
Corde tensione prefissate	•	•	•
Corde tensione riflettenti	•	•	•
Accessori di montaggio	•	•	•
Sacca custodia	•	•	•



STRATO 2  
P. 38



GLOBO 3  
P. 39



STRATO 2 AUTOMATIC  
P. 40



BLITZ 3 AUTOMATIC  
P. 41

TIPO MONTAGGIO	MONO TELO		PRIMA SOPRATELO	
Numero persone	2	3	2	3
Altezza cm	105	130	105	120
Tessuto sopratelo	68D Polyester	68D Polyester	Polyester	Polyester
Colonna d'acqua mm	1000	2000	1500	3000
Spalmatura	PU	PU	PU	PU
Nastratura sopratelo	•	•	•	•
Apertura aerazione	•	•	•	•
Balza perimetrale	-	•	-	-
Tessuto abitacolo	-	Poliestere traspirante	Poliestere traspirante	Poliestere traspirante
Divisorio abitacolo	-	-	-	-
Palaria	Fiberglass	Fiberglass	Fiberglass	Fiberglass
Palaria precollegata	•	•	•	•
Palaria con segnalini colorati	-	•	AUTOMATIC	AUTOMATIC
Fissaggio palaria Ring-Pin	•	•	-	-
Regolazione punti di ancoraggio	-	-	-	-
Pali verticali veranda	•	-	-	-
Numero entrate	1	1	1	1
Finestre Airama	-	-	-	-
Finestre Panorama	-	•	-	-
Stuoia veranda	-	•	-	-
Catino cucito a chiusura totale	-	-	•	•
Zanzariera entrata abitacolo	•	-	•	•
Zanzariera ingressi	-	•	-	-
Ingresso cavo sopratelo	-	-	-	-
Ingresso cavo abitacolo	-	-	-	-
Rinforzi punti max. sollecitazione	-	•	-	-
Tasche interne	•	•	•	•
Gancio appendilampada	•	•	•	•
Corde tensione prefissate	-	•	-	-
Corde tensione riflettenti	-	•	-	-
Accessori di montaggio	•	•	•	•
Sacca custodia	•	•	•	•





WISE  
P. 44



AIR TRAVEL II  
P. 46



ADVANTOURER  
P. 48



TOSCANA  
P. 50



BORA  
P. 51

TIPO MONTAGGIO

PRIMA SOPRATELO

Numero persone	-	-	-	-	-
Altezza cm	210	210	230	-	-
Tessuto sopratelo	Polycotton	Polycotton	Polycotton	Polycotton	Polycotton
Colonna d'acqua mm	-	-	-	-	-
Spalmatura	-	-	-	-	-
Nastratura sopratelo	•	•	•	-	-
Apertura aerazione	•	-	•	•	•
Balza perimetrale	-	•	•	•	•
Tessuto abitacolo	-	-	-	-	-
Divisorio abitacolo	-	-	-	-	-
Paleria	Airtube	Airtube	Airtube	Airtube	Airtube
Paleria precollegata	-	-	-	-	-
Paleria con segnalini colorati	-	-	-	-	-
Fissaggio paleria Ring-Pin	-	-	-	-	-
Regolazione punti di ancoraggio	•	•	•	•	•
Pali verticali veranda	-	-	-	-	-
Numero entrate	3	2	2	1	2
Finestre Airama	-	-	-	•	•
Finestre Panorama	•	•	•	-	-
Stuoia veranda	-	•	-	-	-
Catino cucito a chiusura totale	•	-	•	-	-
Zanzariera entrata abitacolo	-	-	-	-	-
Zanzariera ingressi	•	•	-	-	-
Ingresso cavo sopratelo	•	-	-	-	-
Ingresso cavo abitacolo	-	-	-	-	-
Rinforzi punti max. sollecitazione	•	•	-	•	•
Tasche interne	-	-	-	-	-
Gancio appendilampada	•	•	-	-	-
Corde tensione prefissate	-	•	-	-	-
Corde tensione riflettenti	-	-	-	-	-
Accessori di montaggio	•	•	•	•	•
Sacca custodia	•	•	•	•	•



MARVILLA  
P. 54



TRAILS LC/HC  
P. 56



TROUPER 2.0  
P. 58



TROUPER XL  
P. 59



ALICE  
P. 60

## TIPO MONTAGGIO

## PRIMA SOPRATELO

Altezza cm	210	215	230	230	250
Tessuto sopratelo	Oxford Polyester	Oxford Polyester	Oxford Polyester	Oxford Polyester	Oxford Polyester
Colonna d'acqua mm	3000	3000	3000	3000	3000
Spalmatura	PU	PU	PU	PU	PU
Nastratura sopratelo	•	•	•	•	•
Apertura aerazione	•	•	•	•	•
Balza perimetrale	•	-	•	•	•
Paleria	Airtube	Airtube	Airtube	Airtube	Airtube
Regolazione punti di ancoraggio	•	•	•	•	-
Numero entrate	3	2	2	2	2
Finestre Panorama	•	•	•	•	-
Catino cucito a chiusura totale	-	•	•	•	-
Ingresso cavo sopratelo	•	-	-	-	-
Accessori di montaggio	•	•	•	•	•
Sacca custodia	•	•	•	•	•





BEYOND  
P. 62



RAMBLER  
P. 63



ENTRADA  
P. 64



ALBATROS  
P. 65



NELMORE  
P. 66

## TIPO MONTAGGIO

## PRIMA SOPRATELO

Altezza cm	210	220	210	210	210
Tessuto sopratelo	68D Polyester	68D Polyester	68D Polyester	Pigment Polyester	Oxford Polyester
Colonna d'acqua mm	3000	3000	3000	3000	3000
Spalmatura	PU	PU	PU	PU	PU
Nastratura sopratelo	•	•	•	•	•
Apertura aerazione	•	•	•	•	-
Balza perimetrale	•	-	•	•	•
Paleria	Fiberglass	Fiberglass	Fiberglass	Fiberglass	Fiberglass
Paleria precollegata	•	•	•	•	•
Fissaggio paleria Ring-Pin	•	•	-	•	-
Regolazione punti di ancoraggio	•	•	•	•	•
Numero entrate	2	2	2	2	1
Finestre Panorama	•	•	•	•	•
Catino incernierato	•	-	-	-	-
Catino cucito a chiusura totale	-	•	-	•	-
Ingresso cavo sopratelo	-	-	-	-	•
Accessori di montaggio	•	•	•	•	•
Sacca custodia	•	•	•	•	•







TALENT  
P. 67



PILOTE  
P. 68



PILOTE 5  
P. 69



COMET  
P. 70



ESCAPE  
P. 71

## TIPO MONTAGGIO

## PRIMA SOPRATELO

Altezza cm	220	170	170	205	195
Tessuto sopratelo	100% Polyester	150D Polyester	150D Polyester	150D Polyester	150D Polyester
Colonna d'acqua mm	3000	3000	3000	3000	3000
Spalmatura	PU	PU	PU	PU	PU
Nastratura sopratelo	•	•	•	•	•
Apertura aerazione	•	-	-	•	•
Balza perimetrale	•	•	•	•	•
Paleria	Fiberglass	-	-	-	-
Paleria precollegata	•	-	-	-	-
Fissaggio paleria Ring-Pin	•	-	-	-	-
Regolazione punti di ancoraggio	•	•	•	•	•
Numero entrate	1	1	1	2	1
Finestre Panorama	•	•	•	•	•
Catino incernierato	-	-	-	-	-
Catino cucito a chiusura totale	-	-	-	-	-
Ingresso cavo sopratelo	-	-	-	-	-
Accessori di montaggio	•	•	•	•	•
Sacca custodia	•	•	•	•	•





CHEF 2

P. 81



DINERY

P. 81

VIDA 1 NG  
VIDA 2 NG

P. 82

GUSTO 1 NG  
GUSTO 2 NG  
GUSTO 3 NG

P. 83

Misure cm	200x200	240x240	200x150 200x200	150x150 200x150 200x200
Altezza cm	190/230	190/230	195/215	195/215
Tetto	100% Polyester	100% Polyester	100% PVC	100% PVC
Pareti laterali	100% Polyester	100% Polyester	100% Polyester	100% Polyester
Spalmatura	PU	PU	PU	PU
Finestre Panorama	-	•	•	•
Finestre con zanzariera	•	•	•	•
Finestre oscurabili	•	•	•	•
Paleria	Fiberglass / Acciaio	Fiberglass / Acciaio	Acciaio	Acciaio
Ventilazione permanente	•	•	•	•
Numero entrate	1	1	1	1
Catino cucito	-	-	-	-
Catino incernierato	-	-	-	-
Balza perimetrale	•	•	•	•
Tasche interne	-	-	-	-
Accessori di montaggio	•	•	•	•
Sacca custodia	•	•	•	•







CAMP INN  
P. 84



CORIANDER 1  
CORIANDER 2  
P. 85

Misure cm	220x160	200x150 200x200
Altezza cm	195/220	195 210
Tetto	100% PVC	100% PVC
Pareti laterali	100% PVC	100% PVC
Spalmatura	-	-
Finestre Panorama	•	•
Finestre con zanzariera	•	•
Finestre oscurabili	•	•
Palaria	Acciaio	Acciaio
Ventilazione permanente	•	•
Numero entrate	1	1
Catino cucito	-	-
Catino incernierato	-	-
Balza perimetrale	•	•
Tasche interne	-	-
Accessori di montaggio	•	•
Sacca custodia	•	•







CABINA 2 NG

P. 86



CABINA MAXI

P. 86



SANITY

P. 87



STORAGE PLUS

P. 87

	CABINA 2 NG P. 86	CABINA MAXI P. 86	SANITY P. 87	STORAGE PLUS P. 87
Misure cm	140x140	180x160	140x160	225x160
Altezza cm	205	205	213	175/195
Tetto	100% Polyester	100% Polyester	100% Polyester	100% PVC
Pareti laterali	100% Polyester	100% Polyester	100% Polyester	100% Polyester
Spalmatura	PU	PU	PU	PU
Finestre Panorama	-	-	-	-
Finestre con zanzariera	•	•	•	-
Finestre oscurabili	•	•	•	•
Paleria	Fiberglass	Fiberglass	Acciaio	Acciaio
Ventilazione permanente	•	•	•	-
Numero entrate	1	1	1	1
Catino cucito	-	-	-	•
Catino incernierato	-	-	-	-
Balza perimetrale	•	•	•	•
Tasche interne	•	•	-	•
Accessori di montaggio	•	•	•	•
Sacca custodia	•	•	•	•





# LA CLASSICA TENDA FAMILY

Una tenda si trasforma nella casa di famiglia durante le vacanze in campeggio. Quindi non c'è dubbio che debba essere adatta anche alla famiglia stessa. Mentre le coppie con un figlio non hanno bisogno di troppo spazio, le famiglie con tre figli o quelle che viaggiano con i nonni, hanno bisogno di spazio sufficiente per dormire comodamente, spazio per riporre attrezzature e bagagli, una saletta per giocare in caso di maltempo e spazio per un tavolo da pranzo con sedie. Le tende Family sono generalmente più grandi, progettate per tempi di permanenza più lunghi, per un maggior numero di persone ed offrono più comfort di una pura "tenda per il pernottamento".

Gli ingressi con altezza e le grandi finestre panoramiche sono una chiara caratterizzazione. L'interno delle tende Family è diviso in una zona notte e una zona giorno. Quest'ultima è di norma così spaziosa che è possibile sedersi insieme intorno al tavolo da campeggio mentre si prepara il cibo e i bambini si riposano nelle cabine letto. C'è molto spazio per tutti gli accessori che rivestono un ruolo importante per il successo di una piacevole vacanza.

Nelle pagine seguenti presentiamo una varietà di modelli che soddisfano le diverse esigenze; come il numero di persone, il peso, le dimensioni, l'altezza, le dimensioni dell'imballaggio, la ventilazione, ecc.

Ci dovrebbe essere qualcosa di adatto ad ogni esigenza.

Quindi: leggetele attentamente, ordinate dal vostro rivenditore e la divertente vacanza in campeggio può iniziare!









# POLYCOTTON TENTS



## INNOVAZIONE PER UN FUTURO PIÙ CONFORTEVOLE

La sfida principale degli ultimi anni si è concentrata sulla ricerca di materiali che ci permettessero la costruzione di telai pneumatici ad alta pressione rivoluzionari in grado di sostituire i tradizionali pali metallici o in fibra di vetro. L'idea dominante era quella di togliere la complessità dalle operazioni di montaggio delle tende e di offrire all'utilizzatore un elevato livello di semplicità e comfort.



# I VANTAGGI DELLE TENDE IN POLICOTONE

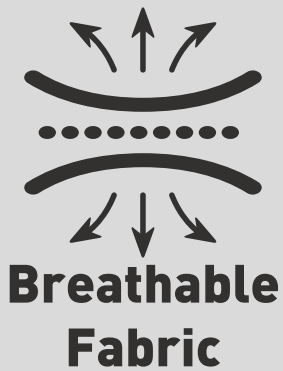

Uno dei principali vantaggi delle tende in policotone è la maggiore traspirabilità e la capacità di adattarsi alle diverse condizioni dell'ambiente circostante. Questo significa semplicemente che quando fa caldo, l'interno della tenda rimarrà più fresco rispetto alle tende in poliestere. Al contrario, con temperature più basse, la vostra tenda sarà più calda.

Traspirabilità significa anche che il policotone previene e riduce la formazione di condensa permettendo all'umidità di passare attraverso il tessuto, eliminando la sgradevole sensazione di umidità e garantendo benessere e comfort.

L'utilizzo del tessuto di policotone è altresì un investimento nella longevità della tenda. Il policotone offre una resistenza ai raggi UV molto più elevata rispetto al poliestere e il deterioramento dovuto agli effetti dell'invecchiamento è fortemente ridotto.

Nel complesso i tessuti in policotone garantiscono ottima funzionalità, traspirabilità e longevità, un mix interamente tecnologico per un prodotto che vi regalerà piacere nel tempo.







# MAISONEL 4

**La nuova tenda familiare Maisonel 4 è realizzata in tessuto misto cotone Pure Pro di alta qualità. Garantisce un clima interno molto piacevole in ogni stagione, è altamente resistente agli strappi e alla pioggia. Dotata dell'innovativo sistema di riposo Creanox, garantisce al campeggiatore una vacanza rilassante. La parte posteriore della tenda e la cabina interna sono molto scure e dotate di ampie aperture a rete. Il sistema di gonfiaggio Oneflate rende il montaggio molto semplice e veloce. Entrambi gli ingressi laterali e una grande finestra a destra nella parete anteriore sono dotati di finestre a zanzariera richiudibili. Questo garantisce una buona ventilazione senza insetti. L'interno spazioso offre spazio confortevole per almeno 4 persone, che può essere ulteriormente ampliato rimuovendo la parete anteriore.**

## CARATTERISTICHE:

- Struttura pneumatica A.I.R. Tech altamente stabile e indipendente
- Sistema di gonfiaggio monostrato, completo di telo di copertura
- Pavimento fisso della tenda cucito
- Parete anteriore completamente rimovibile, richiudibile come veranda, lato destro con finestra a zanzariera, porta al centro, lato sinistro finestra in Crystal, tutte le finestre in Crystal oscurato
- Entrate laterali a destra e a sinistra con finestra in zanzariera, pellicola colorata e oscurante
- Le entrate laterali possono essere montate come tetto apribile, 2 pali di montaggio inclusi
- Ampio abitacolo interno oscurato, parete divisoria apribile al centro con chiusura lampo, numerose tasche portaoggetti, sospensione per lampada, accesso cavi chiudibile dall'esterno
- Ampia zona giorno con tetto a veranda, all'interno con ganci e nastro in velcro per il fissaggio delle luci
- Il tetto della veranda si gonfia automaticamente, incluse 2 finestre in pellicola colorata
- La tenda può essere messa in tensione con scalette in PVC sostituibili
- Tensionamento della tenda con cinghie robuste
- Accesso ai cavi con serratura sul lato destro
- Ganci ed elementi in velcro per il fissaggio delle lampade
- Include una pompa d'aria di alta qualità con valvola di scarico della pressione
- Borsa extra large con cinghie di compressione



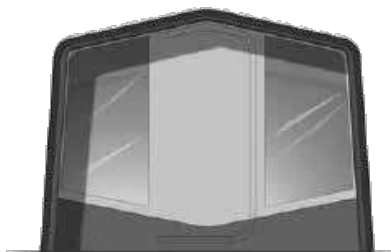









## MAISONEL 4

Art. 0102954N

€ tbc  
1/1/-

-  Polycotton
-  Breathable Polycotton
-  280 x 240 x H200 cm
-  PE
-  470 x 300 x H220 cm
-  AIRTUBE
-  28,5 kg
-  85 x Ø 37 cm

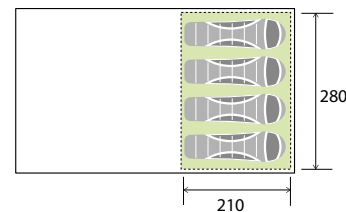
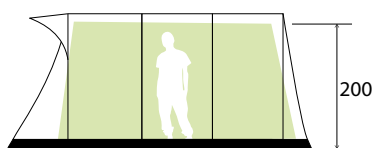
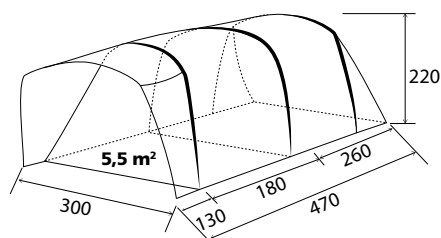

<M> mountless   <O> oneflate   CREATORX





# PURE 4











Pure 4 A.I.R. Tech Authentic è un'eccezionale modello di tenda per famiglie in cerca di molto spazio abitativo. Il tessuto traspirante in policotone mantiene l'interno notevolmente più fresco nelle calde giornate estive, soprattutto quando si trascorrono le vacanze nei climi più caldi. L'ampio verandino frontale garantisce un grande spazio per l'arredamento. Pali verticali inclusi.



## PURE 4

Art. 0102972N

€ tbc  
1/1/7

-  Polycotton
-  Breathable Polycotton
-  210 x 280 x H195 cm
-  PE
-  630 x 310 x H210 cm
-  AIRTUBE
-  37,6 kg
-  85 x Ø 44 cm

 4x **<M>**  
mountless

**a.i.r**  
**tech**  
air inflation raising

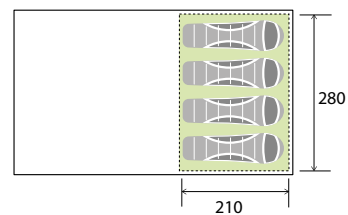
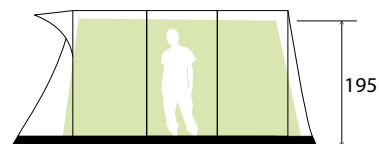
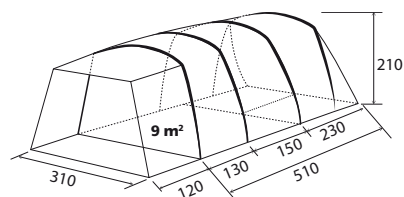

**CREA**NOX Info p. 33



JUNIPER  
P. 308



TITANIUM AXIA  
P. 210

MIX &  
MATCH



RAPTOR CLASSIC  
P. 192



SPACE  
P. 258





# POLYESTER TENTS

100%  
Polyester



**INNOVAZIONE  
PER UN FUTURO  
PIÙ CONFORTEVOLE**





# I VANTAGGI DELLE TENDE IN POLIESTERE



Premesso che esista una quantità elevatissima di tessuti in poliestere e che per la realizzazione di materiali di alta qualità impiegati nell'Outdoor vengono utilizzate altre qualità che per semplici magliette o camicie, il poliestere si è rivelato un ottimo materiale per le seguenti ragioni: leggerezza, alta resistenza a strappi ed usura, buona resistenza UV, bassa dilatazione anche in condizioni di umidità.



**Fabric  
Lightness**



**High Resistance  
To Abrasion**

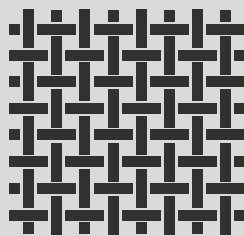

**Very Low Dilatation  
also In Humid Conditions**

**UV** protection



# MANSION 3

La gamma di tende Family Polyester si arricchisce del modello Mansion 3. Il materiale di alta qualità utilizzato assicura un clima interno ottimale, unito a un'altissima resistenza allo strappo ed alla pioggia. L'abitacolo oscurato (sistema Creanox), integrato nella zona extra scura della tenda, garantisce un sonno riposante senza svegliarsi troppo presto. Le finestre in zanzariera extra-large nella tenda e nella cabina letto nella parte anteriore e posteriore consentono un'eccellente ventilazione. L'ampia zona giorno è molto luminosa e può essere trasformata in una grande zona d'ombra aperta grazie alle porte laterali avvolgibili e alla parete anteriore completamente rimovibile. La tenda è facilissima da montare in pochi minuti grazie al sistema Oneflate a valvola singola. Il generoso tettuccio è teso con un'asta in fibra di vetro.

## CARATTERISTICHE:

- Struttura pneumatica A.I.R. Tech altamente stabile e indipendente
- Sistema di gonfiaggio Oneflate
- Catino della tenda cucito tutt'intorno
- Parete anteriore completamente rimovibile, abbassabile con effetto veranda, lato destro con finestra in zanzariera, porta al centro, finestra in pellicola sul lato sinistro, tutte le finestre in pellicola colorata
- Entrate laterali a destra e a sinistra con finestra in zanzariera, pellicola oscurante, arrotolabili lateralmente
- Ampia cabina notte oscurata, parete divisoria al centro apribile con cerniera, numerose tasche portautensili, sospensione per lampada, accesso con cavo chiudibile dall'esterno
- Ampia zona giorno con tendano parasole, ganci e nastro velcro all'interno per il fissaggio delle luci
- Il tetto parasole è teso con pali in fibra di vetro
- La tenda può essere montata mediante elastici a scaletta sostituibili in PVC
- Tensionamento della tenda mediante robuste cinghie
- Apertura accesso cavi chiudibile
- Include una pompa d'aria di alta qualità con valvola di scarico della pressione
- Borsa extra large con cinghie di compressione



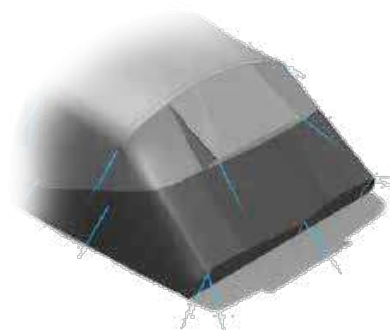
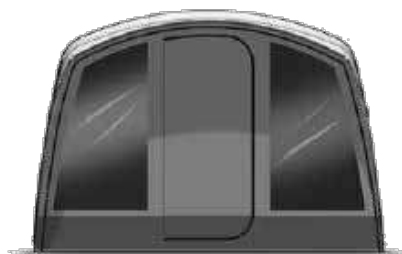



## MANSION 3

Art. 0102955N

€ tbc  
1/1/-

 Polyester Oxford PU 100% Polyester

 Breathable Polycotton

 280 x 210 x H200 cm

 PE

 500 x 300 x H210 cm

 AIRTUBE

 22 kg

 80 x Ø 30 cm

 3000  3x

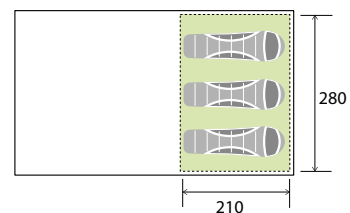
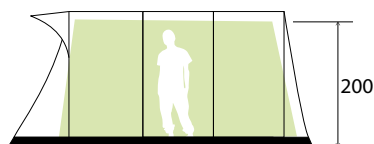
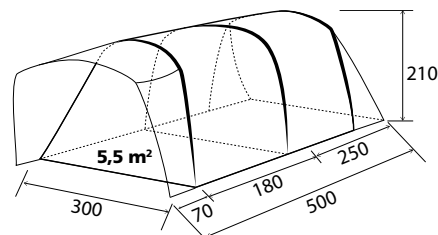

**<M>** mountless **<O>** oneflate **CREATOPX**





**a.i.r**  
**tech**  
air inflation raising

100%  
Polyester  
Oxford

# PARAISO

**La tenda Family pneumatica A.I.R. Tech Paraiso unisce in modo perfetto elementi di design moderno, tecnica di costruzione e funzionalità a 360 gradi. Grazie alle grandi aperture di aerazione ed alle ampie finestre panoramiche che sfiorano il catino, viene sempre garantito un'ottimo livello di ventilazione interna. Numerosi ed utili dettagli funzionali fanno sì che la Paraiso si monti con sorprendente velocità e facilità e che rappresenti, anche per questa ragione, il compagno perfetto per delle vacanze spensierate e divertenti.**

## **CARATTERISTICHE:**

- Struttura pneumatica molto stabile
- 3 tubi aria indipendenti sistema A.I.R. Tech
- Catino a cucitura perimetrale
- Parete frontale rimovibile
- Grandi finestre Airama
- Tetto abitacolo con sistema Creanox
- Porta laterale dotata di zanzariera
- Ventilazione interna efficace
- Ampia veranda anteriore
- Con pompa a mano di alta qualità
- Sono inclusi picchetti in materiale plastico, corde tensione e borsa per il trasporto









## PARAISO 5/6

Art. 0102981N

€ tbc  
1/1/6

 Polyester Oxford PU 100% Polyester

 Breathable Polyester

 (140+210) x 215 x H195 cm

 PE

 540 x 380 x H215 cm

 AIRTUBE

 24,8 kg

 80 x Ø 35 cm

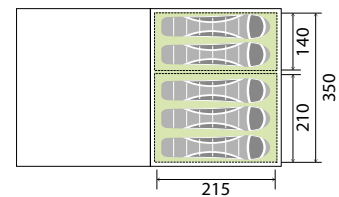
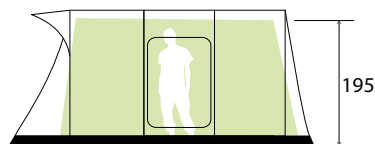
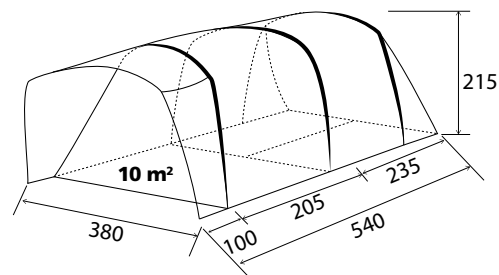

## INFO

### CREANOX

Brunner Creanox è un nuovo sistema per tutti coloro il cui sonno è influenzato dalla luce del giorno.

Creanox filtra gran parte della luce diurna e consente un sonno più lungo e riposante - in qualsiasi momento della giornata.

Tutte le tende della collezione Brunner Family dotate del sistema Creanox sono contrassegnate in questo catalogo con un logo speciale.





# CAPRICE 5

La tenda familiare Caprice 5 per 5 persone è progettata per il camping in tutta comodità. Spazio a sufficienza per tutta la famiglia. Realizzata in poliestere Oxford leggero e altamente stabile. Il montaggio avviene con 5 pali in fibra di vetro molto stabili e robuste cinghie di fissaggio. L'ampia dotazione non lascia nulla a desiderare. La zona notte oscurata della tenda, la cabina letto extra dark (sistema di sonno Brunner Creanox) e le grandi aperture a rete nelle pareti anteriore e posteriore garantiscono un sonno riposante anche in pieno giorno. Il catino della tenda cucito perimetralmente tiene lontani gli insetti e l'acqua. L'ampia zona giorno può essere trasformata in un'ampia zona ombreggiata grazie alle porte laterali avvolgibili e alzabili e alla parete anteriore completamente rimovibile. Per la ventilazione serale, è possibile aprire 4 grandi finestre a zanzariera.

## CARATTERISTICHE:

- Grande tenda familiare per 5 persone con ampio spazio abitativo
- Catino della tenda cucito perimetralmente
- 2 ingressi laterali, arrotolabili e alzabili
- 2 pali inclusi
- Parete anteriore completamente rimovibile, abbassabile con effetto veranda, lato destro con finestra in zanzariera, porta al centro, finestra in pellicola sul lato sinistro, tutte le finestre in pellicola colorata
- Zona giorno con 2 grandi finestre a zanzariera che possono essere oscurate tramite pellicola colorata
- Tutte le finestre possono essere oscurate all'interno
- Ampio abitacolo oscurato, parete divisoria apribile con chiusura lampo, numerose tasche portaoggetti, sospensione per lampada, passaggio cavi chiudibile dall'esterno
- Ampia zona giorno con tettuccio, ganci e nastro in velcro all'interno per il fissaggio del sistema di illuminazione
- La tenda può essere montata con elastici a scaletta in PVC sostituibili
- Tensionamento della tenda mediante robuste cinghie
- Passaggio cavi richiudibile sul lato destro
- Borsa custodia extra large con cinghie di compressione







## CAPRICE 5

Art. 0102960N

€ tbc  
1/1/-

 Polyester Oxford PU 100% Polyester

 350 x 210 x H200 cm

 PE

 620 x 370 x H205 cm

 Fiberglass

 35 kg

 80 x Ø 37 cm

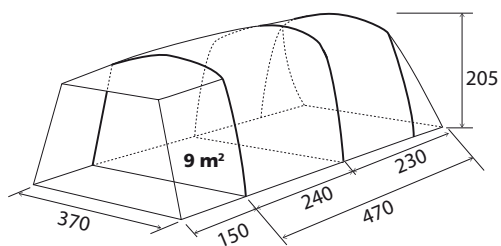

 3000 mm  
 5x

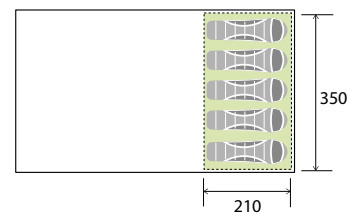
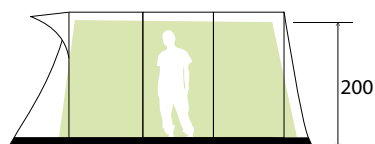

CREAFOX





100% Polyester  
Oxford

# KALYNDA

## KALYNDA 5

Art. 0102999N

€ tbc  
1/1/12

**Tenda Family con struttura classica a 3 archi e catino integrato in resistente tessuto PE.**

150D Oxford Polyester PU (100% Polyester)

Breathable Polyester

(200+140) x 220 x H195 cm

PE

Fiberglass / Steel

External Poles

18 kg

80 x Ø 27 cm

3000 mm 5x

### CARATTERISTICHE:

- Ideale per famiglie
- Catino integrato
- 1 entrata
- 2 abitacoli indipendenti
- Finestre Panorama
- Ottima ventilazione
- Porta anteriore alzabile a veranda
- Ottimo rapporto spazio/superficie
- Pali verticali inclusi

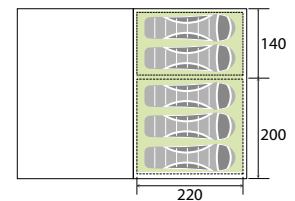
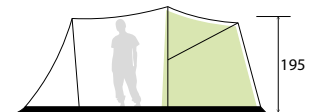
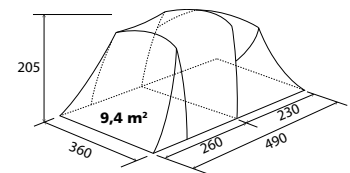



100%  
Polyester  
Oxford

# ARQUS

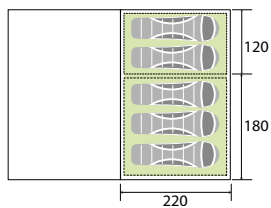
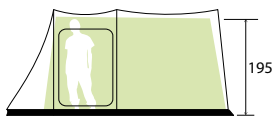
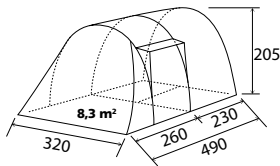

**Tenda a tunnel che con il suo ampio allestimento offre tanta sicurezza e comfort al campeggiatore Outdoor.**

#### CARATTERISTICHE:

- Montaggio veloce
- Leggera
- 2 Ingressi
- Catino cucito a chiusura totale
- Finestre Crystal tinte
- Palaria codificata a colori
- Cuciture nastrate
- Gancio per lampade
- Parete divisoria della cabina interna chiudibile mediante cerniera
- Sono inclusi picchetti in plastica, tiranti, sacca custodia e pali verticali

## ARQUS OUTDOOR 5

Art. 0103057N

€ tbc

1/1/12

 Polyester PU 100% Polyester

 Breathable Polyester

 300 x 220 x H195 cm

 PE

 Fiberglass

 External Poles

 16,5 kg

 78 x Ø 26 cm

 3000mm  
 5x







## STRATO 2

Art. 0103088N.C70

€ tbc  
6 / 6 / -

# STRATO



 Polyester PU 100% Polyester

 205 x 150 x H105 cm

 PE

 Fiberglass

 External Poles

 2,1 kg

 64 x Ø 14 cm



Tenda monotelo con apertura di ventilazione in sommità di cupola. Completa di accessori di montaggio e sacca custodia.

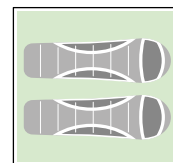
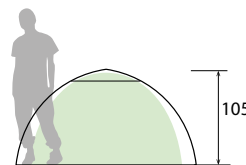
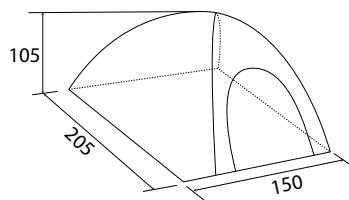

## INFO

### CONSIGLI PER L'UTILIZZO CORRETTO DELLA TENDA

Prima di partire per le vacanze in tenda effettuate sempre un montaggio di prova. In tal modo potrete arrivare a destinazione conoscendo già la procedura di montaggio e contemporaneamente verificare che tutto sia a posto. Applicate sempre le corde di controventatura badando a non esagerare con la tensione. In caso di forte vento sostituite i picchetti in dotazione con picchetti antibufera. Su terreni particolarmente duri o rocciosi è consigliato l'uso di appositi spilloni. Alcune condizioni meteorologiche favoriscono la formazione di condensa all'interno della tenda. Per minimizzare questo processo naturale evitate di appendere biancheria o abbigliamento bagnato nella tenda, aumentate il livello di ventilazione interna e utilizzate un telo di protezione salvacatino. Prima di riporre la tenda provvedete a togliere possibili residui di sporco mediante una morbida spugnetta bagnata con semplice acqua. Evitate di lavare la tenda con la lavatrice o mediante l'utilizzo di prodotti chimici. Controllate che la tenda sia completamente asciutta prima di ripiegarla per evitare formazione di muffa o cattivi odori. Infine è consigliabile portare sempre con sé un kit riparazione che includa pali ed elastici di ricambio, toppe adesive per la riparazione di eventuali strappi, cordini antibufera e qualche picchetto di riserva.













## GLOBO 3

Art. 0103083N

€ tbc  
4 / 4 / -

# GLOBO



-  68D Polyester PU/Alu 100% Polyester
-  Breathable Polyester
-  210 x 205 x H125 cm
-  PE
-  Fiberglass
-  External Poles
-  5 kg
-  56 x Ø 21 cm

2000  
3x

La tenda a cupola è l'ideale compagno di viaggio grazie al peso leggero, al montaggio facile e veloce ed allo spazio sufficiente per il bagaglio. Sono inclusi picchetti in plastica, tiranti, sacca custodia.

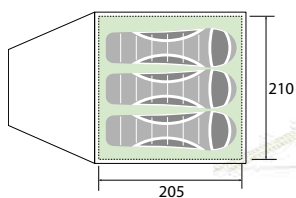
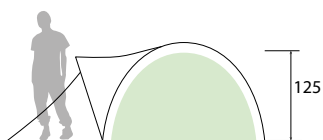
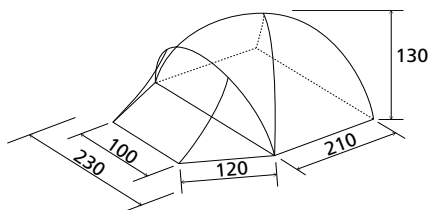



# STRATO 2 AUTOMATIC

**Tenda a cupola automatica per 2 persone. Montata e pronta all'uso in pochissimi secondi grazie allo speciale sistema di tensionamento a cavi integrati. Monotelo con grande porta chiudibile a cerniera. Completa di sacca custodia ed accessori di montaggio.**

## CARATTERISTICHE:

- Costruzione monotelo
- 2 aperture di ventilazione laterali
- Abitacolo con zanzariera
- Tasca interna
- Aste automatiche in fibra di vetro Ø 8,5 mm con trazione a fune
- Catino in materiale PE impermeabile

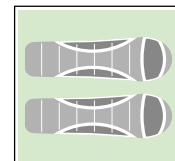
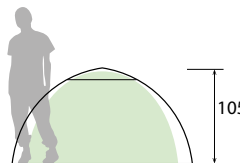
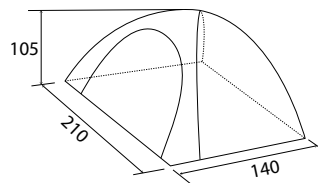

## STRATO 2 AUTOMATIC

Art. 0102978N

€ tbc  
2 / 6 / 84

100% Polyester

Fiberglass / Automatic

210 x 140 x H105 cm

2,3 kg

62 x Ø 15 cm

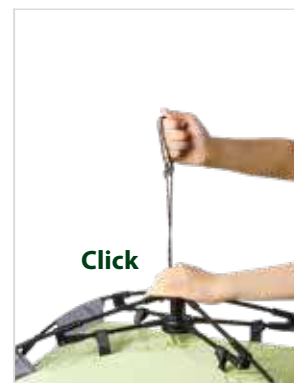





# BLITZ 3 AUTOMATIC

**Tenda automatica a cupola con doppio tetto e comoda abside. Grazie alla moderna struttura con tecnologia di trazione a fune integrata, può essere montata e pronta all'uso in pochi secondi. Corde premontate. Dimensioni compatte e peso ridotto. Con borsa per il trasporto.**

## CARATTERISTICHE:

- Costruzione a doppio tetto con abside
- Ingresso anteriore protetto dalle intemperie
- 1 ventilazione nella zona del tetto con copertura
- 2 aperture di ventilazione laterali
- Abitacolo con zanzariera e copertura
- Tasca interna
- Aste automatiche in fibra di vetro Ø 8,5 mm con trazione a fune
- Catino in materiale PE impermeabile

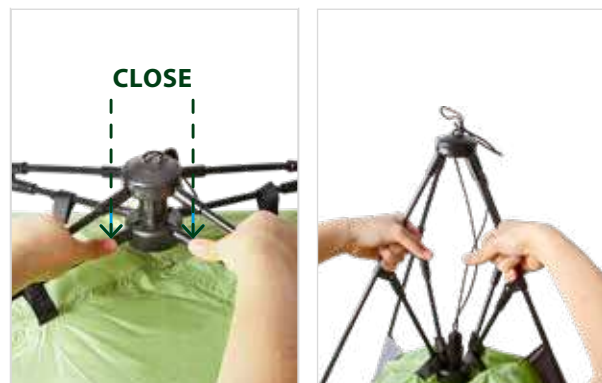
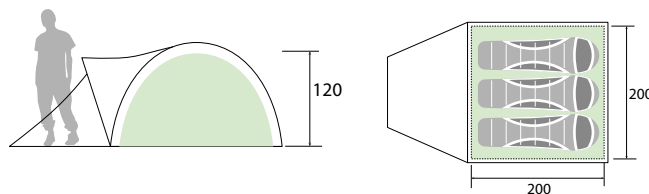
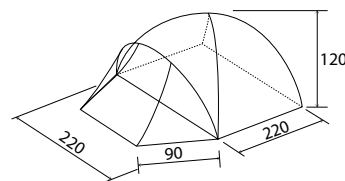

## BLITZ 3 AUTOMATIC

Art. 0102980N

€ tbc

2 / 2 / 84

 100% Polyester

 200 x 200 x 120 cm

 Fiberglass / Automatic

 310 x 220 x 120 cm

 3,8 kg

 76 x Ø 16 cm







# DRIVE-AWAY AWNINGS

60/40  
Polycotton

100%  
Polyester



## INNOVAZIONE PER UN FUTURO PIÙ CONFORTEVOLE

Viaggiare in minibus significa libertà e flessibilità, ma richiede una certa autosufficienza e la possibilità di allestire rapidamente un accampamento mobile.

Sia che preferiate fare un breve week-end con gli amici o coccolare la vostra famiglia con una settimana di vacanza rilassante, la nostra collezione di verande minibus con telaio ad aria è la soluzione ideale se desiderate un po' più comfort, spazio e un montaggio semplice e senza problemi. Godetevi una vacanza da sogno senza stress ed arrabbiature.

La collezione di verande minibus Brunner continuerà a crescere e sarà ampliata da numerosi e interessanti nuovi modelli.

Gli sforzi per un funzionamento ottimale, l'alta qualità e l'ulteriore sviluppo del livello di comfort rimangono invariati:

- La creazione di spazio aggiuntivo per vivere, dormire e ripostiglio
- Utilizzo alternativo come zona cottura per mantenere i fastidiosi odori fuori dall'abitacolo del veicolo
- La possibilità di prenotare la tua piazzola preferita anche in caso di assenza

Le tende ad aria Brunner A.I.R.Tech sono disponibili per diverse altezze di montaggio.

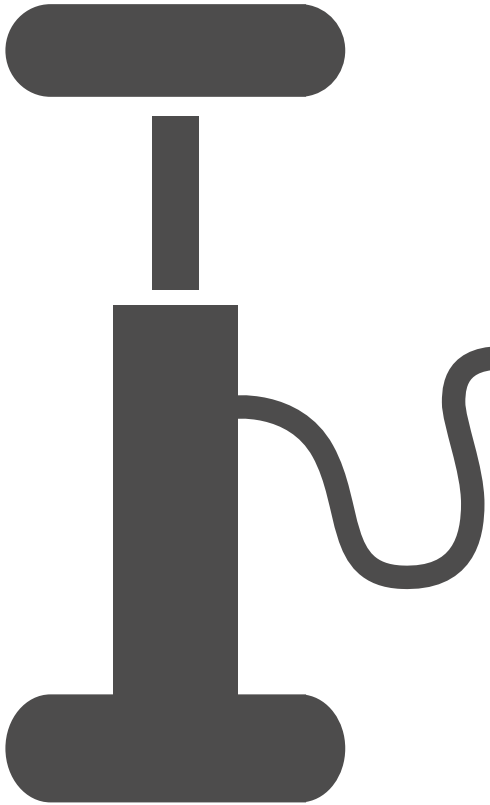

# QUICK MOUNTING



## INFO

**Tutti i modelli di tende e verande Brunner con la denominazione Polycotton sono realizzate con uno speciale tessuto dalle eccellenti proprietà outdoor. Si tratta di un materiale non spalmato che si sigilla naturalmente con un contenuto di cotone del 40%, ma senza rinunciare alle proprietà positive del tessuto in poliestere (contenuto 60%).**

### CIÒ COMPORTA I SEGUENTI VANTAGGI:

- Traspirante, quindi sensibile miglioramento del clima interno della tenda/veranda
- Significativa riduzione della formazione di acqua di condensazione
- Significativamente più resistente ai raggi UV rispetto alle tende in poliestere comparabili
- Maggiore longevità operativa



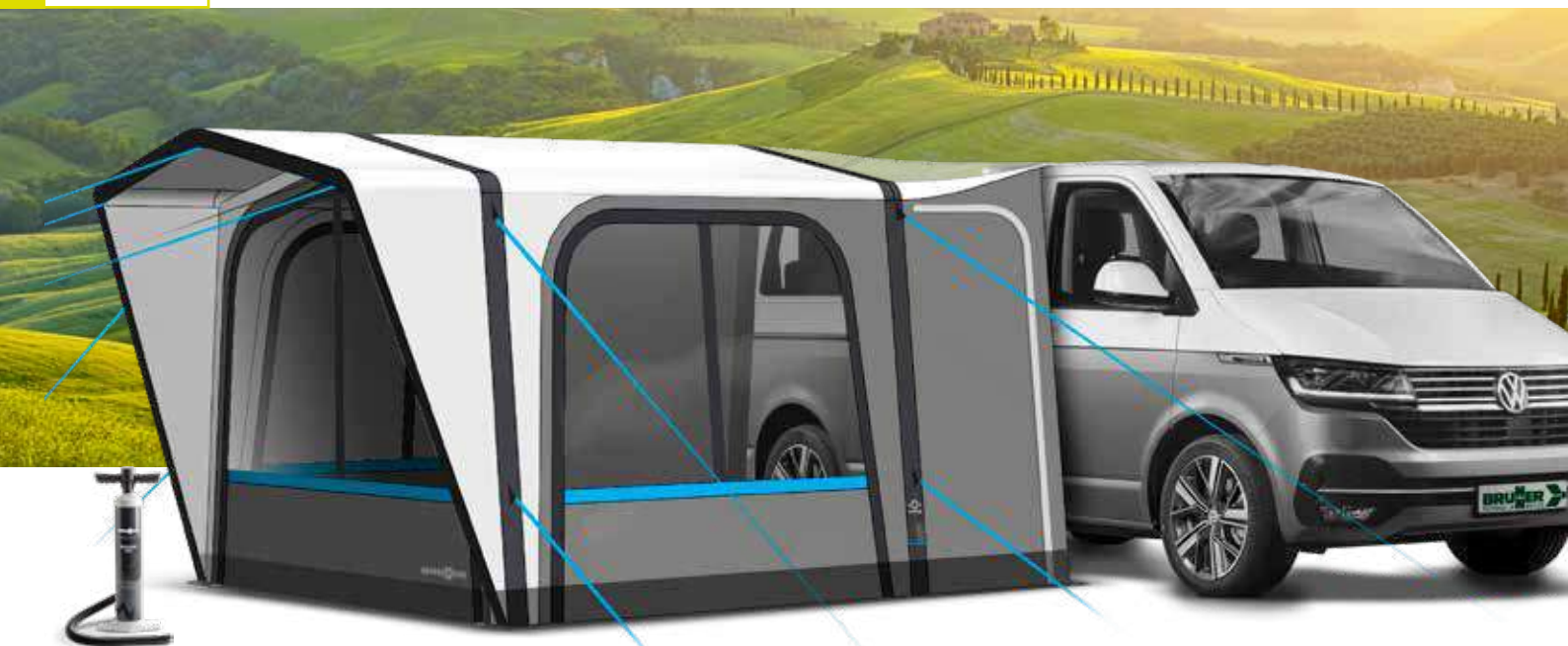

**a.i.r.**  
**tech**  
air inflation raising

<O>  
**oneflate**

**NEW**  
**2023**

60/40  
Polycotton

# WISE

**Veranda indipendente con struttura gonfiabile A.I.R. Tech. I due archi verticali e la tettoia sono collegati tramite i tubi del tetto. Ciò consente un allestimento molto rapido mediante il sistema di gonfiaggio Oneflate. Tutte e quattro le pareti (compresa quella posteriore) sono rimovibili (padiglione aperto). Tre elementi della parete sono dotati di una finestra a rete con copertura in pellicola colorata e oscurante. Due pareti hanno un'entrata. Questa tenda può anche essere fissata a veicoli di diverse altezze con il nostro sistema a 3 tunnel. Il pavimento cucito perimetralmente conferisce alla tenda una maggiore stabilità, protegge dal vento e dall'acqua piovana e tiene lontani gli insetti.**

## CARATTERISTICHE:

- Possibilità di scegliere tra tre misure di tunnel di collegamento: 190 cm - 220 cm, 220 cm - 250 cm, 250 cm - 280 cm
- Struttura pneumatica A.I.R. Tech altamente stabile e indipendente
- Sistema di gonfiaggio ad una sola camera (telaio ad aria monocamera)
- Tutte e 4 le pareti (compresa la parete posteriore) possono essere rimosse e utilizzate con effetto veranda; la parete posteriore può anche essere aperta a metà
- Tre pareti intercambiabili, ciascuna con finestra in zanzariera (pellicola colorata Crystal all'esterno, oscurante all'interno) e una finestra in pellicola Crystal colorata con oscurante
- Due pareti con ingresso
- Tunnel di collegamento con porta separata a destra
- Tettuccio antipioggia a gonfiaggio automatico
- Catino completamente cucito
- Balza perimetrale esterna
- Tensionamento della tenda mediante robuste cinghie
- La tenda può essere tesa con elastici a scaletta in PVC sostituibili
- Accesso per cavi con chiusura lampo nella parete posteriore
- Ganci ed elementi in velcro per il fissaggio delle lampade
- È inclusa una pompa d'aria di alta qualità con valvola di sicurezza
- Borsa di trasporto extra large con cinghie di compressione
- Abitacolo interno disponibile come opzione

## OPZIONI DI COLLEGAMENTO AL VEICOLO:

- Con profilo keder 5/7 mm
- Con palo di collegamento
- Cinghie di fissaggio con clip per le barre del tetto
- Corde per il fissaggio passando sul tetto

## WISE

Art. 0102936N

€ tbc  
1 / 1 / -

 Polycotton

 PE

 AIRTUBE

 380 x 280 x H210 cm

 24 kg

 80 x Ø 30 cm

<M>  
mountless



Double  
Connection  
5 / 7



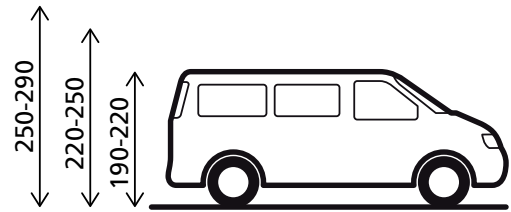
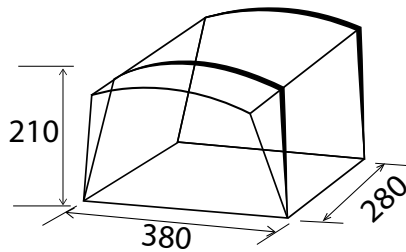

### CONNECTION TUNNELS

				M.O	Master	
Art. 0102937N	190-220 cm	Polycotton	€ tbc	1	1	-
Art. 0102938N	220-250 cm	Polycotton	€ tbc	1	1	-
Art. 0102935N	250-280 cm	Polycotton	€ tbc	1	1	-

## OPTIONAL

### VESTIBOL MULTITENT

Art. 0102934N

€ tbc

1/1/-

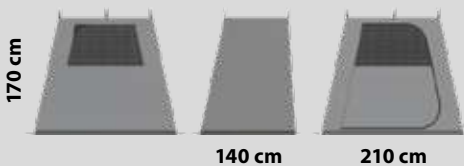
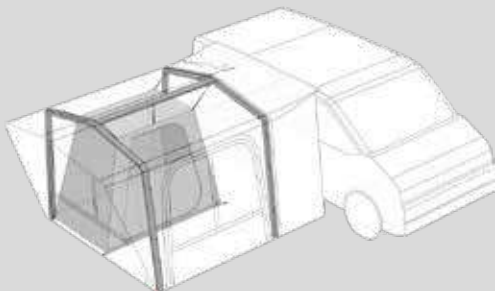

La cabina interna Vestibol Multitent di nuova concezione è realizzata in tessuto di poliestere di colore scuro. Questo filtra gran parte della luce del giorno e consente un sonno più lungo e riposante. Quasi tutta la parete anteriore (210 cm) può essere aperta mediante una cerniera. È integrata anche un'ampia finestra in zanzariera, che può essere chiusa con un rivestimento in tessuto sul lato interno. Due tasche portautensili cucite nella parete posteriore consentono di tenere in ordine le cose. La cabina interna è fissata in alto e in basso con cinghie.

#### CARATTERISTICHE:

- Poliestere scuro, filtra la luce del giorno
- Parte anteriore con ampio ingresso
- Parte anteriore e posteriore con finestre in zanzariera
- Cinghie di fissaggio superiori e inferiori
- Due tasche portaoggetti integrate



# AIR TRAVEL II

**La Air Travel II, di nuova concezione, è dotata di una struttura ad aria A.I.R. Tech di alta qualità con sistema di gonfiaggio Oneflate. Tutti gli elementi in tessuto sono realizzati in robusto policotone Pure Pro, che conferisce alla tenda un clima interno molto piacevole e una scarsa formazione di condensa. L'elevata resistenza ai raggi UV garantisce una durata estremamente lunga della tenda.**

## CARATTERISTICHE:

- Struttura pneumatica A.I.R. Tech altamente stabile e indipendente
- Sistema di gonfiaggio ad una sola camera (struttura ad aria monocamera)
- Ampio ingresso anteriore, che può essere allestito come tettoia parasole (2 pali inclusi), completamente rimovibile, finestre colorate con oscuramento
- Ingresso laterale a destra, configurabile come tettuccio parasole
- Portellone con porta separata a destra
- Parete posteriore completamente rimovibile, apribile a metà, utilizzabile come veranda (frangivento)
- Grandi finestre laterali oscurate con zanzariera e oscuranti
- Piccole finestre oscurate nel soggiorno, con oscuranti
- Stuoia veranda
- Balza perimetrale esterna
- Tensionamento della tenda mediante robuste cinghie
- La tenda può essere montata con elastici a scaletta in PVC sostituibili
- Accesso ai cavi con serratura nella parete posteriore
- Ganci ed elementi in velcro per il fissaggio delle lampade
- Include una pompa d'aria di alta qualità con valvola di sicurezza
- Borsa extra large con cinghie di compressione
- Cabina interna ordinabile come optional
- Per veicoli con altezza grondaia di 170 - 210 cm

## OPZIONI DI COLLEGAMENTO AL VEICOLO:

- Con profilo keder 5/7 mm
- Con palo di collegamento
- Cinghie di fissaggio con clip per le barre del tetto
- Corde per il fissaggio passando sul tetto





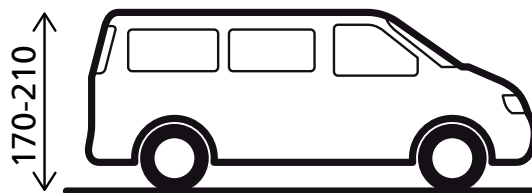
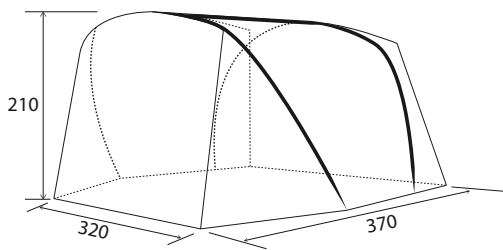

## AIR TRAVEL II

Art. 0102956N

€ tbc  
1/1/-

 Polycotton

 PE

 370 x 320 x H210 cm

 AIRTUBE

 28,5 kg

 80 x Ø 30 cm

<M>  
mountless



Double  
Connection  
5/7





**a.i.r.**  
**tech**  
air inflation raising

60/40  
Polycotton

# ADVANTOURER

**L'Advantourer è la tenda ideale per il vostro van. Grazie al suo telo esterno in policotone le sue prestazioni in termini di traspirabilità e resistenza ai raggi UV sono di gran lunga superiori rispetto alle tradizionali tende in poliestere.**

## CARATTERISTICHE:

- Struttura A.I.R. Tech, indipendente
- Catino cucito
- Tunnel di collegamento con porta d'accesso laterale
- Verandino frontale con laterali per la protezione dal sole e dalla pioggia
- Soggiorno con finestre con zanzariera (con oscuranti)
- Porta d'ingresso ampia e con zanzariera, con un'apertura variabile - parziale o completa
- Grande ingresso laterale
- Pali verticali inclusi

Adatta per veicoli con altezza grondaia da: 180 - 240 cm













## ADVANTOURER

Art. 0102970N

€ tbc  
1/1/6

-  Polycotton
-  Breathable Polycotton
-  PE
-  AIRTUBE
-  (140+200+100) x 350 x H230 cm
-  32,1 kg
-  80 x Ø 41 cm



Attenzione!  
Non adatta per campeggio  
stanziale/stagionale

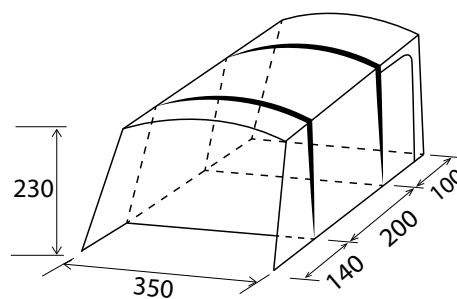

## OPTIONAL

### ADVANTOURER CABIN

Art. 0102971N

€ tbc  
1/4/29

Camera interna (abitacolo) per tenda Advantourer, fornibile come optional.





**a.i.r. tech**  
air inflation raising

60/40  
Polycotton

# TOSCANA

**Veranda ad inserimento totale di nuova concezione con stabile struttura pneumatica e forma del tetto leggermente arrotondata per una resistenza particolarmente efficace alle intemperie. Il design moderno e la combinazione di colori rendono la Toscana una vera e propria attrazione. L'utilizzo semplice e agevole in assenza di pali fa battere il cuore di ogni campeggiatore già all'inizio del montaggio. Il design di alta qualità in tutti i settori con un'ampia dotazione di serie garantisce il 100% di comfort in campeggio.**

## CARATTERISTICHE:

- Sistema di gonfiaggio Oneflate (sistema di tubi d'aria a camera singola)
- Parete anteriore composta da due segmenti, può essere rimossa dal tetto con una cerniera o aperta come veranda
- Zanzariera superiore oscurabile
- Palo antibufera sotto tutte le finestre
- Cerniere extra forti
- Fissaggio cinghia antibufera integrato
- Pompa d'aria con valvola di sicurezza e accessori di montaggio inclusi



M.O.

Master



Art. 0102952N.T05	830 - 870 cm	Polycotton	AIRTUBE	29 kg	€ tbc	1	1	-
Art. 0102952N.T06	871 - 910 cm	Polycotton	AIRTUBE	31 kg	€ tbc	1	1	-
Art. 0102952N.T07	911 - 950 cm	Polycotton	AIRTUBE	33 kg	€ tbc	1	1	-
Art. 0102952N.T08	951 - 990 cm	Polycotton	AIRTUBE	35 kg	€ tbc	1	1	-
Art. 0102952N.T09	991 - 1030 cm	Polycotton	AIRTUBE	38 kg	€ tbc	1	1	-
Art. 0102952N.T10	1031 - 1070 cm	Polycotton	AIRTUBE	39,8 kg	€ tbc	1	1	-

oneflate



Double  
Connection  
5/7





**a.i.r.**  
**tech**  
air inflation raising

60/40  
Polycotton





# BORA

La veranda Bora ad inserimento totale è un highlight ottico tra le tende pneumatiche e stabilisce nuovi standard in termini di design. Colpisce per le due linee moderne e funzionali e l'uso di materiali di costruzione di eccellente qualità. Il design molto ampio delle finestre frontali e laterali crea un clima abitativo inondato di luce e aria. Grazie al montaggio semplice e agevole senza pali, si può incominciare subito a vivere un'esperienza di camping tranquilla e rilassante.

**CARATTERISTICHE:**

- Sistema di gonfiaggio Oneflate (sistema di tubi d'aria a camera singola)
- Parete anteriore può essere rimossa dal tetto con una zip o aperta come veranda
- Finestre con tende
- Alta ventilazione con protezione dalle intemperie con zanzariera oscurabile
- Palo antibufera sotto tutte le finestre
- Cerniere extra forti
- Fissaggio cinghia antibufera integrato
- Pompa d'aria con valvola di sicurezza e accessori di montaggio inclusi



						M.O.	Master	
Art. 0102953N.T05	830 - 870 cm	Polycotton	AIRTUBE	29 kg	€ tbc	1	1	-
Art. 0102953N.T06	871 - 910 cm	Polycotton	AIRTUBE	31 kg	€ tbc	1	1	-
Art. 0102953N.T07	911 - 950 cm	Polycotton	AIRTUBE	33 kg	€ tbc	1	1	-
Art. 0102953N.T08	951 - 990 cm	Polycotton	AIRTUBE	35 kg	€ tbc	1	1	-
Art. 0102953N.T09	991 - 1030 cm	Polycotton	AIRTUBE	38 kg	€ tbc	1	1	-





# RHOMBUS VAN



Bellissimo tendalino parasole per minibus e van. Pronto all'utilizzo in pochissimi minuti grazie alla sua solida struttura pneumatica. Realizzato interamente in tessuto Pure Pro ad alta resistenza UV. Utilizzando le pareti laterali (disponibili come optional), è possibile ottenere un ampio spazio di soggiorno protetto dal vento, dalle intemperie e dagli sguardi indiscreti.

## CARATTERISTICHE:

- Struttura pneumatica A.I.R.Tech altamente stabile
- Sistema di gonfiaggio mono-camera ad aria Oneflate
- Numerosi punti di ancoraggio
- Montaggio semplice e veloce

Una pompa d'aria di alta qualità con valvola di sicurezza é inclusa.

Fornita con: picchetti, corde di ancoraggio e grande borsa per il trasporto

## OPZIONI DI COLLEGAMENTO AL VEICOLO:

- Con doppio profilo di collegamento

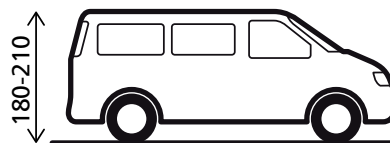

## RHOMBUS VAN

Art. 0102957N

€ tbc

1 / 1 / -

Polycotton

260 x 200 x H210 cm

AIRTUBE

11,2 kg

66 x Ø 24 cm

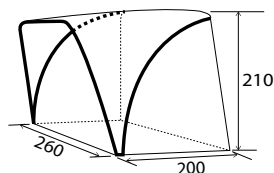

## OPTIONAL

## RHOMBUS VAN SIDEWALL SET

Art. 0102943N

€ tbc

1 / 10 / -

Polycotton

Set 3 pareti per tendalino parasole Rhombus Van.  
Montaggio semplice e veloce.





# SKIA 300/400



I tendalini parasole SKIA rappresentano il naturale sviluppo della tecnologia A.I.R.Tech e consentono di completarne l'inserimento, il gonfiaggio e l'ancoraggio in pochissimi minuti ed in assoluta comodità. Decade contemporaneamente la necessità di utilizzare i tradizionali pali in metallo o in fibra di vetro. Utilizzando le pareti laterali (disponibili come optional), è inoltre possibile ottenere un ampio spazio di soggiorno protetto dal vento, dalle intemperie e dagli sguardi indiscreti. Lo SKIA è semplicissimo da montare grazie alla sua struttura pneumatica composta da un palo di sostegno anteriore ed ad un palo di stabilizzazione del tetto. Il collegamento al mezzo avviene mediante un profilo di scorrimento precucito. Dal design moderno ed accattivante, questo tendalino parasole è prodotto utilizzando il speciale tessuto Pure Pro, un policotone con spalmatura PU che garantisce un'ottima resistenza ai raggi UV, un'ottima traspirabilità ed una lunga durata di utilizzo. Tutte le cuciture sono nastrate per garantire l'impermeabilità dell'ambiente interno.

La fornitura comprende una pompa per il gonfiaggio della struttura, gli accessori di montaggio (picchetti e corde tensione) ed una pratica borsa per il trasporto. Disponibile in varie misure ed altezze di collegamento.

## CARATTERISTICHE:

- Montaggio facile e veloce
- Con palo tetto pneumatico
- Connessione mediante profilo di scorrimento
- Include la pompa d'aria, la borsa ed il materiale di montaggio

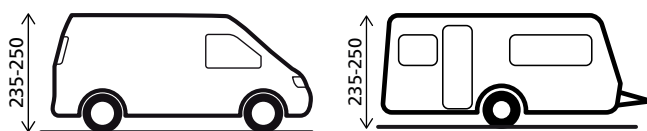

## SKIA 300

Art. 0102931N

€ tbc  
1/1/-

- ▲ Polycotton
- ✏ 300 x 250 x H250 cm
- ✂ AIRTUBE
- 📖 13,5 kg
- 📏 70 x Ø 28 cm

## SKIA 400

Art. 0102932N

€ tbc  
1/1/-

- ▲ Polycotton
- ✏ 400 x 250 x H250 cm
- ✂ AIRTUBE
- 📖 15,5 kg
- 📏 70 x Ø 30 cm

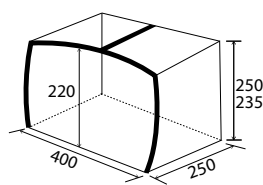
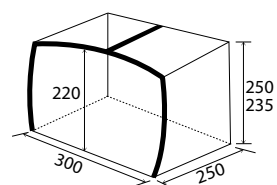

## OPTIONAL

### SKIA SIDEWALL SET

Art. 0102933N

€ tbc  
1/1/-

- ◆ Polycotton

Set 2 pareti laterali per tendalino parasole Skia (adatto per entrambe le misure del tendalino). Montaggio semplice e veloce.



# MARVILLA



La veranda indipendente per van Marvillà è realizzata in tessuto di poliestere Oxford di alta qualità e presenta numerose funzionalità. Montaggio molto rapido grazie al sistema di gonfiaggio Oneflate. Struttura indipendente dotata della collaudata tecnologia A.I.R. Tech Crossbeam. Grazie al nuovo tunnel di collegamento (ingresso aggiuntivo sul lato destro), la veranda può essere montata su veicoli con un'altezza di 180 cm - 220 cm. Tutte le pareti (compresa quella posteriore) possono essere completamente rimosse (padiglione aperto). Le pareti laterali destra e sinistra possono essere invertite l'una rispetto all'altra (ingresso laterale destro o sinistro). Su entrambi i lati è possibile fissare un'estensione della tenda (230 cm x 220 cm). L'estensione può essere chiusa completamente ed è dotata di una finestra di ventilazione. La tenda e l'estensione hanno un pavimento completamente cucito e offrono quindi una protezione ideale da vento, pioggia e insetti.

## CARATTERISTICHE:

- Altezza del tunnel di collegamento 180 cm-220 cm, con ingresso a destra
- Struttura pneumatica A.I.R. Tech Crossbeam altamente stabile e indipendente
- Sistema di gonfiaggio Oneflate (telaio ad aria monogamer)
- Tre pareti possono essere completamente rimosse e utilizzate con effetto veranda. Ciascuna di esse è dotata di una finestra in zanzariera (pellicola Crystal colorata all'esterno, oscurante all'interno) e di una finestra a pellicola Crystal colorata con oscurante
- La parete posteriore può essere aperta completamente, semiaperta e utilizzata con effetto veranda (frangivento)
- 1 ingresso laterale, 1 ingresso dalla parete anteriore, 1 ingresso dal tunnel di collegamento a destra
- Tettuccio parapioggia sul lato destro
- Stuoia veranda
- Balza perimetrale esterna
- Molteplici corde di ancoraggio
- Elastici a scaletta sostituibili
- Accesso per cavi con cerniera nella parete posteriore
- Ganci ed elementi in velcro per il fissaggio delle lampade
- È inclusa una pompa di alta qualità con valvola di sicurezza
- Sacca extra large con cinghie di compressione

## POSSIBILITÀ DI COLLEGAMENTO AL VEICOLO:

- Con profilo keder 5/7 mm
- Con palo di collegamento
- Cinghie di fissaggio con clip per le barre del tetto
- Corde per il fissaggio sopratetto



Attenzione!

Non adatta per campeggio stanziale/stagionale

## MARVILLA

Art. 0102939N

€ tbc  
1 / 1 / -

Polyester Oxford PU 100% Polyester

250 x 210 x H210 cm

PE

AIRTUBE

300 + 230 x 360 x H210 cm

24,5 kg





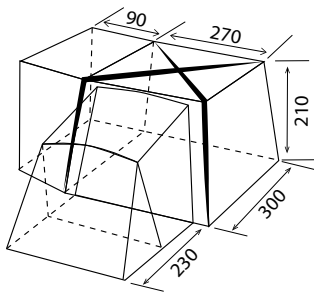
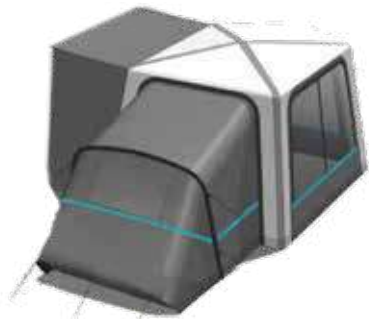

## OPTIONAL

### VESTIBOL MULTITENT

Art. 0102934N

€ tbc

1/1/-

La cabina interna Vestibol Multitent di nuova concezione è realizzata in tessuto di poliestere di colore scuro. Questo filtra gran parte della luce del giorno e consente un sonno più lungo e riposante. Quasi tutta la parete anteriore (210 cm) può essere aperta mediante una cerniera. È integrata anche un'ampia finestra in zanzariera, che può essere chiusa con un rivestimento in tessuto sul lato interno. Due tasche portaoggetti cucite nella parete posteriore consentono di tenere in ordine le cose. La cabina interna è fissata in alto e in basso con cinghie.

#### CARATTERISTICHE:

- Poliestere scuro, filtra la luce del giorno
- Parte anteriore con ampio ingresso
- Parte anteriore e posteriore con finestre in zanzariera
- Cinghie di fissaggio superiori e inferiori
- Due tasche portaoggetti integrate

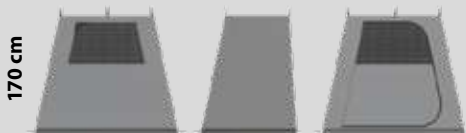
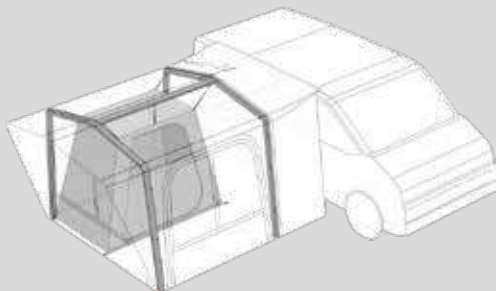

140 cm

210 cm



# TRAILS LC/HC

**Tenda indipendente per Minibus con struttura pneumatica A.I.R. Tech a 2 archi. Accesso diretto al mezzo mediante entrata aggiuntiva nel tunnel di collegamento.**

## **CARATTERISTICHE:**

- Tutte le finestre sono oscurabili
- 2 entrate (1 anteriore - 1 laterale) con zanzariera
- Tettuccio frontale di protezione
- Ampio tunnel di collegamento
- 1 porta d'accesso attraverso il tunnel di collegamento
- Parete posteriore apribile completamente
- 2 aperture di ventilazione permanente
- Porta ingresso cavi elettrici con sistema portacavo
- Catino cucito a copertura totale
- Numerosi ancoraggi antibufera
- Ottima stabilità
- Con accessori di montaggio e sacca custodia
- Pali verticali inclusi

## **COLLEGAMENTO AL VEICOLO MEDIANTE:**

- Profilo di scorrimento
- Asta di collegamento
- Nastri per corrimano con chiusura a contatto

Adatta per veicoli con altezza grondaia da 180 a 220 cm (TRAILS LC) / 245 a 280 cm (TRAILS HC)

Accessori di serie: palo di collegamento, corde tensione, picchetti, sacca custodia, pompa doppia azione

**<M>**  
mountless

**a.i.r.**  
tech  
air inflation raising







### TRAILS LC

Art. 0102984N

€ tbc  
1 / 1 / 12

Polyester Oxford PU 100% Polyester

PE

AIRTUBE

320 x (220+100) x H180/220 cm

18 kg

80 x Ø 33 cm

Double Connection 5/7

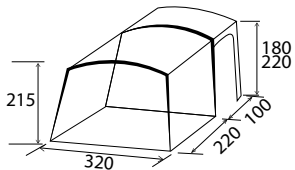

### TRAILS HC

Art. 0102975N

€ tbc  
1 / 1 / 12

Polyester Oxford PU 100% Polyester

PE

AIRTUBE

320 x (220+100) x H215 cm

18 kg

80 x Ø 33 cm

Double Connection 5/7

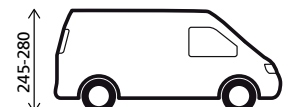
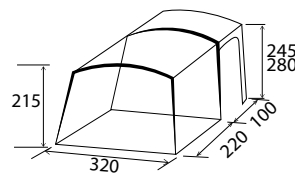



**a.i.r. tech**  
air inflation raising

# TROUPER 2.0

100% Polyester  
Oxford

La nuova versione 2.0 della prestigiosa veranda per minibus Troupier, si presenta con una nuova struttura pneumatica, che ottimizza lo sfruttamento dello spazio a parità di superficie occupata. Tutte le altre caratteristiche esclusive della collezione di tende per minibus A.I.R. Tech rimangono invariate. Con un tunnel di collegamento che copre un'altezza da 180 a 230 cm, la Troupier 2.0 è adatta anche per l'uso su minibus di medie dimensioni.

## CARATTERISTICHE:

- Spaziosa tenda per minivan
- Costruzione indipendente
- Costruita con tecnologia Crossbeam
- Porte d'ingresso con zanzariera
- Pompa a doppia azione inclusa
- Catino cucito perimetralmente
- Grandi finestre Panorama
- Ventilazione supplementare nel tetto
- Numerosi punti di controventatura

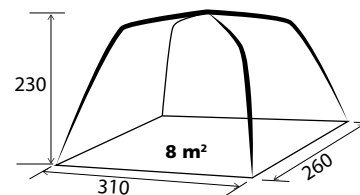

## COLLEGAMENTO AL VEICOLO MEDIANTE:

- Profilo di scorrimento
- Asta di collegamento
- Nastri per corrimano con chiusura a contatto

Adatta per veicoli con altezza grondaia da 180 a 230 cm

Accessori di serie: telo tenda con catino, paleria, palo di collegamento, corde tensione, picchetti, sacca custodia



Attenzione!  
Non adatta per campeggio stanziale/stagionale

## OPTIONAL



### TROUPER CABIN

Art. 0102989N

€ tbc  
6 / 12 / -

- 140 x 220 x H155 cm
- 100% Polyester

Camera interna per tenda Troupier 2.0, fornibile come optional.

## TROUPER 2.0

Art. 0102995N

€ tbc  
1 / 1 / 12

150D Oxford Polyester PU (100% Polyester)

AIRTUBE

310 x 260 x H230 cm

20,5 kg

80 x Ø 35 cm







**a.i.r.**  
**tech**  
air inflation raising

# TROUPER XL

100% Polyester  
Oxford

**Tenda pneumatica per minibus sviluppata sulla base del modello A.I.R. Tech Trouper.**

## CARATTERISTICHE:

- Spaziosa tenda per minibus con grande abside anteriore
- Struttura pneumatica A.I.R. Tech con sistema di gonfiaggio Oneflate
- Costruzione indipendente
- Tecnologia Crossbeam
- Con pompa a mano con valvola di sovrappressione
- Catino cucito a copertura totale
- Porte d'ingresso con zanzariera
- Ampie finestre panoramiche
- Ventilazione aggiuntiva sul tetto
- Sopratelo con ingresso cavi
- Numerosi punti di controventatura
- Pali verticali inclusi
- Abitacolo opzionale

## POSSIBILITÀ DI COLLEGAMENTO AL VEICOLO:

- Mediante profilo di scorrimento
- Mediante palo di collegamento
- Al corrimano mediante nastri con chiusura a contatto

Altezza di collegamento (grondaia del veicolo): 180-230 cm

Fornitura: telo esterno con catino, palo di collegamento, corde tensione, picchetti, sacca custodia

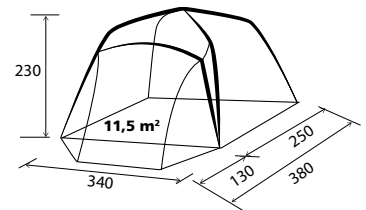

Attenzione!  
Non adatta per campeggio  
stanziale/stagionale

## TROUPER XL

Art. 0102977N

€ tbc  
1 / 1 / 9



▲ 150D Oxford Polyester PU (100% Polyester)

▲ AIRTUBE / Fiberglass

▲ (130+250) x 340 x H230 cm

▲ 23,4 kg

▲ 82 x Ø 38 cm

3000 mm  
▲ oneflate



**a.i.r**  
**tech**  
air inflation raising

100%  
Polyester  
Oxford

# ALICE

**Alice è una veranda altamente innovativa dotata di struttura pneumatica A.I.R. Tech a valvola singola. Offre la massima comodità a tutti coloro che necessitano di spazio supplementare per la loro caravan.**

**CARATTERISTICHE:**

- Struttura pneumatica A.I.R. Tech
- Montaggio e smontaggio semplici e veloci
- Tubi pneumatici a 3 strati
- Con tendalino parasole
- Grandi entrate laterali con pannelli di ventilazione
- Con pompa doppia azione
- Una pratica borsa per il trasporto e gli accessori di montaggio sono inclusi nella fornitura

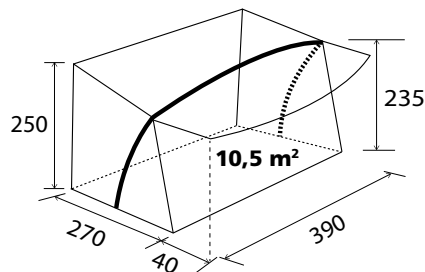

## ALICE

Art. 0102991N

€ tbc

1 / 1 / 14

300D Polyester Oxford 100% Polyester

AIRTUBE

390 x 270 x H235/250 cm

22 kg

85 x Ø 35 cm



<M>  
mountless



Attenzione!  
Non adatta per campeggio  
stanziale/stagionale







**a.i.r.**  
**tech**  
air inflation raising

100%  
Polyester  
Oxford

# SKIA CAMPERVAN

Tendalino parasole con telaio gonfiabile (tecnologia A.I.R. Tech) per minibus e furgoni. Pronto all'uso in pochi secondi. Montaggio semplice grazie alla pompa dell'aria fornita di serie. I tubi pneumatici flessibili prevengono possibili danni al veicolo anche in caso di forte vento. Con predisposizione per il fissaggio di pareti laterali opzionali. Sono inclusi gli accessori di montaggio.

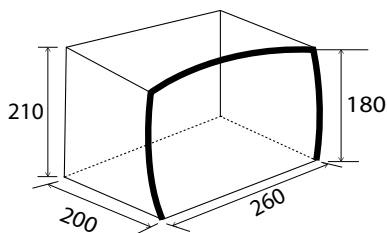

## SKIA CAMPERVAN

Art. 0103005N

€ tbc

1 / 1 / 25

260 x 200 x H180/210 cm

AIRTUBE

150D Oxford Polyester PU (100% Polyester)

11 kg

65 x Ø 20 cm

Double  
Connection  
5/7

<M>  
mountless



Attenzione!  
Non adatta per campeggio  
stanziale/stagionale



OPTIONAL

## SKIA CAMPERVAN SIDEWALLS

Art. 0102964N

€ tbc

1 / 10 / 50

150D Polyester

Set di due pareti laterali.



# BEYOND



**Veranda indipendente con un eccellente rapporto qualità/prezzo.**

**POSSIBILITÀ DI COLLEGAMENTO AL VEICOLO:**

- Mediante profilo di scorrimento
- Mediante palo di collegamento
- Al corrimano mediante nastri con chiusura a contatto
- Mediante adattatore speciale per profilo (optional)

Altezza di collegamento (grondaia del veicolo): 180-220 cm

Accessori di serie: telo esterno, paleria, asta aprichiusa, corde di tensione, picchetti, sacca custodia

Fornibile come optional: stuoia Trip 250x350 cm - 0201243N.C20

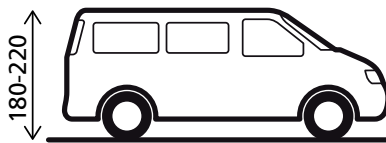
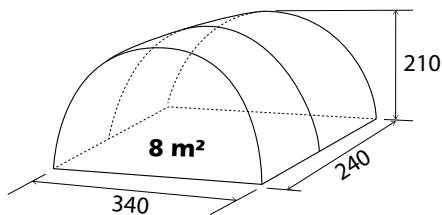

## BEYOND

Art. 0103029N

€ tbc  
1 / 1 / 24

68D Polyester PU 100% Polyester

Durawrap Fiberglass 12,7 mm

External Poles

240 x 340 x H210 cm

12 kg

75 x Ø 25 cm



Attenzione!  
Non adatta per campeggio  
stanziale/stagionale



## OPTIONAL

### BEYOND CABIN

Art. 0103071N

€ tbc  
1 / 12 / -

140 x 220 x H175 cm

Camera interna (abitacolo) per tenda Beyond.





# RAMBLER



**Spaziosa tenda per van e minibus di concezione moderna. Ottima ventilazione. Struttura collaudata e indipendente che permette di usufruire del mezzo per eventuali escursioni senza smontare la tenda.**

## CARATTERISTICHE:

- 4 grandi finestre oscurabili
- 1 finestra con zanzariera di ventilazione
- 2 entrate
- Parete posteriore apribile completamente
- 2 aperture di ventilazione permanente
- Porta ingresso cavi elettrici con sistema portacavo
- Porta laterale alzabile a tendalino
- Catino cucito a copertura totale
- Numerosi ancoraggi antibufera
- Asola portalamпада centrale

## COLLEGAMENTO AL VEICOLO MEDIANTE:

- Profilo di scorrimento
- Asta di collegamento
- Nastri per corrimano con chiusura a contatto

Adatta per veicoli con altezza grondaia: 180-220 cm

Accessori di serie: telo tenda con catino, paleria, pali verticali, palo di collegamento, corde tensione, picchetti, sacca custodia.

## RAMBLER

Art. 0103019N

€ tbc  
1 / 1 / 20

 100% Polyester

 Fiberglass

 External Poles

 350 x 260 x H220 cm

 12,8 kg

 74 x Ø 24 cm

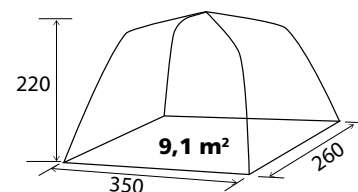

Attenzione!  
Non adatta per campeggio  
stanziale/stagionale





**BEST  
SELLER**



**100%  
Polyester**

# ENTRADA

## ENTRADA

Art. 0103006N

€ tbc  
1 / 1 / 25

 Polyester PU 100% Polyester

 Fiberglass

 External Poles

 310 x 270 x H210 cm

 10,5 kg

 74 x Ø 24 cm

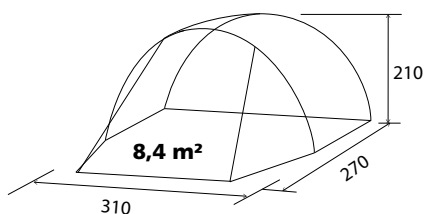

**Tenda per van indipendente di dimensioni compatte, adatta per il collegamento a veicoli con un'altezza grondaia di 180-220 cm.**

### CARATTERISTICHE:

- Montaggio semplice e veloce mediante classici pali in fibra di vetro
- Rapporto ottimale tra spazio e superficie grazie alla forma a tunnel
- Balza perimetrale
- Porte frontali e laterali alzabili a tettuccio parasole (con pali opzionali)
- Ottima sistema di controventatura
- Ampia finestra trasparente
- Pratico ingresso laterale
- Aperture di ventilazione integrate

### Collegamento al veicolo mediante:

- Profilo di scorrimento
- Asta di collegamento
- Nastri per corrimano con chiusura a contatto

**La dotazione comprende:** telo esterno, asta aprichiusa, corde di tensione, picchetti, sacca custodia.



Attenzione!  
Non adatta per campeggio  
stanziale/stagionale

**MIX&  
MATCH**



BULA  
P. 200



SPECTRACOOOL 25  
P. 350





# ALBATROS

## ALBATROS

Art. 0103052N

€ tbc  
1 / 1 / 20

 Pigment Polyester PU (100 % Polyester)

 Fiberglass

 External Poles

 340 x (100+240) x H210 cm

 15,1 kg

 70 x 25 x 25 cm

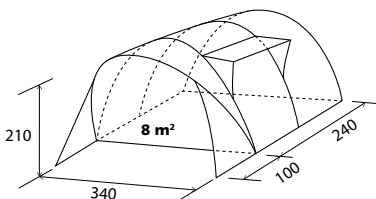

Attenzione!  
Non adatta per campeggio  
stanziale/stagionale

Tenda per Minibus moderna e indipendente.

### CARATTERISTICHE:

- Parete anteriore removibile
- Entrata laterale con tettuccio
- Completa di balza perimetrale
- Con catino
- Ottima aerazione interna
- Tutte le finestre con copertura
- Parete posteriore chiudibile

### POSSIBILITÀ DI FISSAGGIO AL MEZZO:

- Mediante profilo di scorrimento
  - Mediante palo di collegamento
  - Al corrimano mediante nastri con chiusura a contatto
  - Mediante adattatore speciale per profilo (optional)
- Altezza fissaggio (grondaia del veicolo):** 180-220 cm  
**Accessori di serie:** telo, catino, paleria, palo di fissaggio, tiranti, picchetti, sacca custodia.



OPTIONAL

## ALBATROS CABIN

Art. 0103053N

€ tbc  
1 / 12 / 44

 140 x 220 x H175 cm

Camera interna (abitacolo) per tenda Albatros.



OPTIONAL

## MAGNETIC ADAPTER SET

Art. 7401016N

€ tbc  
4 / 4 / -

 3 m

L'adattatore magnetico rappresenta un sistema semplice e pratico per collegarsi a veicoli sprovvisti di canalina. Aderisce perfettamente ai tetti piatti in lamiera di acciaio.



# NELMORE AUTOMATIC

La nuova veranda per van Brunner Instant Drive Away è imbattibile in termini di tempo di montaggio. Sono sufficienti pochi minuti per mettere in piedi la veranda grazie ai pali pieghevoli automatici di nuova concezione. I pali sono dotati di giunti ad apertura automatica e si montano quasi da soli. I giunti si bloccano dopo l'apertura e garantiscono alla veranda un appoggio sicuro. La tela della veranda, realizzata in poliestere Oxford di alta qualità, è fissata ai pali con degli occhielli. Si allunga automaticamente durante il processo di apertura. Entrambe le pareti laterali sono dotate di un'ampia finestra in garza con pellicola colorata da chiudere. La parete anteriore è completamente rimovibile e può essere ripiegata per ottenere un effetto veranda. La dotazione di serie comprende anche un'ampia finestra a rete, anch'essa richiudibile con pellicola Crystal colorata, e una finestra a pellicola Crystal. La parete posteriore può essere aperta completamente o a metà. Il tunnel di collegamento è dotato di una porta autonoma a destra e può essere montato su veicoli con un'altezza della grondaia fino a 220 cm. I tettucci sono tensionati mediante un'asta in fibra di vetro.

## CARATTERISTICHE:

- Altezza tunnel 180 cm - 220 cm, con ingresso a destra
- Telaio automatico istantaneo
- La parete anteriore può essere completamente rimossa e utilizzata come veranda. Ciascuna con una finestra a rete (pellicola Crystal colorata all'esterno, oscurante all'interno) e una finestra a pellicola colorata con oscurante
- La parete posteriore può essere aperta completamente, semiaperta e utilizzata come veranda (frangivento)
- 1 ingresso dalla parete anteriore, 1 ingresso nella serratura a destra
- 3 piccoli tettucci per la pioggia
- Stuoia Veranda
- Balze perimetrali esterne
- Molteplici corde di tensione
- Elastici a scaletta sostituibili
- Accesso per i cavi con chiusura a cerniera nella parete posteriore
- Ganci ed elementi in velcro per il fissaggio delle luci
- Borsa di trasporto extra large con cinghie di compressione
- Cabina interna opzionale, L:210cm x L:140cm x H:170cm

## POSSIBILITÀ DI COLLEGAMENTO AL VEICOLO:

- Con profilo keder 5/7 mm
- Con palo di collegamento
- Cinghie di fissaggio con clip per le barre del tetto
- Tiranti per il tensionamento sopratetto

## NELMORE

Art. 0102941N

€ tbc  
1 / 1 / -

100% Polyester

PE

Fiberglass / Automatic

320 x 320 + 90 x H210 cm

15 kg

80 x Ø 20 cm

3000 mm  
 Double Connection 5/7



Attenzione!  
Non adatta per campeggio  
stanziale/stagionale

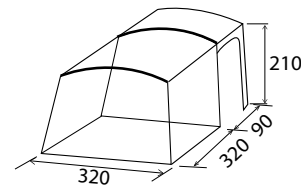
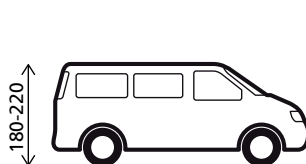





# TALENT

La veranda indipendente per tutti i minibus e van fino a un'altezza della grondaia di 220 cm. Realizzata in poliestere di alta qualità può essere utilizzata universalmente su veicoli con portellone posteriore, porte posteriori e ingresso laterale. Nella parte posteriore, viene fissata con delle corde sopra il portellone oppure alle porte posteriori. Ai lati, il tessuto della tenda viene teso e fissato al suolo. I lati sono dotati di un'ampia finestra in zanzariera, che può essere chiusa con una pellicola Crystal oscurante. La parete anteriore è completamente rimovibile, può essere utilizzata con effetto veranda e presenta un'ampia finestra in zanzariera che può essere chiusa con pellicola Crystal. Tutte le finestre possono essere oscurate dall'interno. Anche la parete posteriore è completamente rimovibile e può essere adattata al tipo di veicolo. Per l'uso laterale, la tenda posteriore e quella laterale possono essere fissate a una veranda con inferiore da 5/7 mm. La rapidità di montaggio grazie al robusto telaio in acciaio tubolare, al quale la tenda viene agganciata e poi tesa, rende facile anche l'allestimento e lo smontaggio quotidiano.

## CARATTERISTICHE:

- Per altezze del veicolo da 180 cm a 220 cm (grondaia)
- Pali tubolari in acciaio autoportanti con telo in poliestere Oxford agganciabile
- La parete anteriore può essere completamente rimossa e utilizzata con effetto veranda, con finestra a rete (pellicola colorata all'esterno, oscurante all'interno)
- Pareti laterali con ampia finestra a rete, chiudibile con pellicola oscurante all'interno
- La parete posteriore può essere aperta completamente, semiaperta e utilizzata come veranda (frangivento)
- Ingresso nella parete anteriore
- Stuoia Veranda
- Balza perimetrale esterna
- Molteplici punti di tensionamento della tenda
- Elastici a scaletta sostituibili
- Accesso cavi con cerniera nella parete posteriore
- Ganci per il fissaggio delle luci
- Borsa di trasporto extra large con cinghie di compressione

## POSSIBILITÀ DI COLLEGAMENTO AL VEICOLO:

- Con profilo keder 5/7 mm
- Con palo di collegamento
- Cinghie di fissaggio con clip per le barre del tetto
- Tiranti per il tensionamento sopratetto

## TALENT

Art. 0102940N

€ tbc  
1 / 1 / -

 100% Polyester

 PE

 Fiberglass

 280 x 320 x H220 cm

 14 kg

 80 x Ø 20 cm



Attenzione!  
Non adatta per campeggio  
stanziale/stagionale

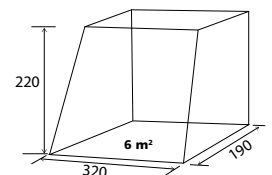



100%  
Polyester  
Oxford

# PILOTE CADDY 4

## PILOTE

Art. 0102967N

€ tbc

1 / 1 / 48

 150D Oxford Polyester

 135 x 135 x H170/200 cm

 2,5 kg

 50 x Ø 12 cm



Tenda posteriore senza telaio appositamente sviluppata per essere fissata al portellone posteriore del VW Caddy. Ideale per creare ulteriore spazio nella parte posteriore del veicolo e per ottenere una maggiore libertà di movimento al suo interno. Montaggio semplice e veloce.

1 grande porta d'ingresso garantisce una buona ventilazione e un clima interno piacevole. Con materiale di fissaggio e borsa per il trasporto.



Attenzione!  
Non adatta per campeggio  
stanziale/stagionale

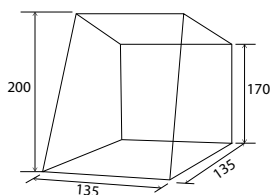



NEW  
2023

# PILOTE CADDY 5

**Nuova tenda posteriore, senza telaio, ulteriormente sviluppata, applicabile al portellone posteriore del VW Caddy 5. Con questa tenda, molto ben accessoriata, l'abitacolo del Caddy si arricchisce di un comodo spazio per pranzare o per riporre i propri oggetti. La tenda viene fissata al portellone posteriore del veicolo con robuste cinghie. Le parti laterali sono fissate al veicolo con strisce magnetiche per renderle impermeabili alla pioggia. Nella zona inferiore, la Pilote Caddy 5 è legata saldamente al veicolo. La balza perimetrale esterna consente il deflusso di grandi quantità d'acqua. La parete anteriore può essere arrotolata o eretta come tettuccio parasole. Le due grandi finestre in zanzariera sul lato destro della tenda e sulla parete anteriore consentono un ottimo flusso d'aria. Le corde e i numerosi tiranti conferiscono alla tenda un elevato grado di stabilità.**

## CARATTERISTICHE:

- Tenda senza telaio con elevata stabilità al vento
- Robuste cinghie per il fissaggio al portellone posteriore
- Le pareti laterali possono essere fissate al veicolo, ben tese nella parte inferiore
- Parete anteriore completamente arrotolabile, con ampia finestra a rete (richiudibile con pellicola Crystal colorata, oscuramento interno)
- La parete anteriore può essere alzata a tettuccio parasole, con 2 pali inclusi
- Parete laterale destra con grande finestra in zanzariera, dotazione come nella parete anteriore
- Parete laterale sinistra con finestra fumé, oscuramento interno
- Balza perimetrale con occhielli
- Elastici a scaletta intercambiabili
- Picchetti in plastica da 30 cm
- Incl. borsa per il trasporto

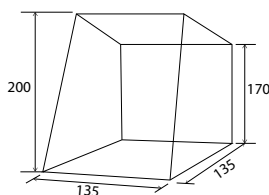

## PILOTE CADDY 5

Art. 0102944N

€ tbc  
1/1/-
 150D Oxford Polyester

 135 x 135 x H200 cm

 2,5 kg

 50 x Ø 12 cm

Attenzione!  
Non adatta per campeggio  
stanziale/stagionale



100%  
Polyester  
Oxford

# COMET

## COMET

Art. 0102968N

€ tbc  
1 / 1 / 48

 150D Oxford Polyester PU

 200 x 200 x H205 cm

 5,1 kg

 63 x 18 cm



Attenzione!  
Non adatta per campeggio  
stanziale/stagionale

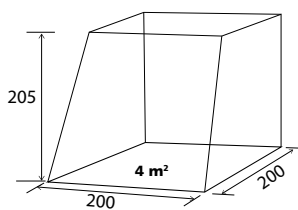





# ESCAPE

La tenda per portellone posteriore Escape, di nuova concezione, si adatta a diversi modelli di veicoli con struttura identica: Peugeot Traveller, Citroën Spacetourer e Toyota Proace. L'installazione è un gioco da ragazzi. Il tetto della tenda viene semplicemente posizionato sul portellone posteriore e poi fissato con strisce magnetiche e cinghie. Le pareti laterali sono fissate con strisce magnetiche incorporate. Nella zona inferiore, il sopratelo della tenda è teso con numerosi elastici a scaletta sostituibili. Questa tecnica consente il montaggio senza attrezzi in pochi minuti. L'ampia parete anteriore può essere completamente arrotolata o essere alzata come tettuccio parasole. Una grande finestra in zanzariera è cucita su questa parete e può essere chiusa con una pellicola Crystal colorata, con oscuramento all'interno. Entrambe le finestre laterali sono realizzate con pellicola Crystal oscurante. La balza perimetrale esterna protegge dall'acqua piovana. Le stabili corde di ancoraggio e i numerosi tiranti rendono la tenda molto stabile al vento.

## CARATTERISTICHE:

- Tenda senza telaio con elevata stabilità al vento
- Lunga durata grazie al poliestere Oxford 150D
- Robuste cinghie per il fissaggio al portellone posteriore
- Le pareti laterali possono essere fissate al veicolo, ben tese nella parte inferiore
- Parete anteriore completamente arrotolabile, con ampia finestra in zanzariera (richiudibile con pellicola Crystal colorata, oscuramento interno)
- La parete anteriore può essere alzata a tettuccio parasole, con 2 pali di sostegno inclusi
- Pareti laterali destra e sinistra con finestra oscurata, oscuramento interno
- Balza perimetrale con occhielli
- Elastici a scaletta sostituibili
- Picchetti in plastica da 30 cm
- Ampia borsa di trasporto con cinghie di compressione
- Il portabiciclette può rimanere montato sul portellone posteriore

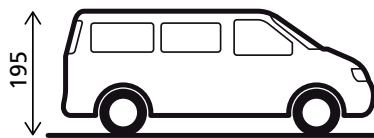
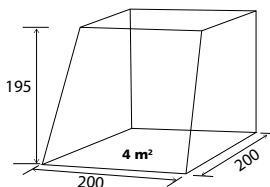

Attenzione!  
Non adatta per campeggio  
stanziale/stagionale

## ESCAPE

Art. 0102945N

€ tbc  
1 / 1 / -

	150D Oxford Polyester
	200 x 200 x H195 cm
	4,5 kg
	63 x 18 cm



# LIBELLE

Il tettuccio parasole Libelle di nuova concezione è il compagno di viaggio ideale per i veicoli ricreazioni fino ad un'altezza di 250 cm. Il robusto materiale 75D Ripstop utilizzato è molto resistente agli strappi e alla pioggia, con un'elevata stabilità ai raggi UV. La tettoia lunga 490 cm (250 + 2x120 cm) viene montata con robusti pali telescopici in alluminio e fissata con robuste cinghie di fissaggio. Gli elementi laterali antivento e di privacy, lunghi 120 cm, possono essere agganciati insieme e fissati sotto il tetto principale, se necessario. In questo modo si riduce l'ingombro e si ottiene una migliore visione panoramica. Il peso ridotto e le dimensioni di stivaggio compatte fanno di questo tettuccio parasole-pioggia high-tech il compagno di viaggio perfetto.

## CARATTERISTICHE:

- Protezione di alta qualità contro il sole e la pioggia in Polyester Ripstop 75D
- Può essere fissata con robuste cinghie
- Pali telescopici in alluminio di alta qualità inclusi
- Incluse ventose saldamente aderenti con ganci
- Può essere montata su una superficie di 250 cm x 250 cm
- Elementi laterali di protezione dal vento e della privacy, ripiegabili verso l'interno
- Molto leggera e di dimensioni ridotte
- Picchetti di plastica da 30 cm
- Ampia borsa di imballaggio

## POSSIBILITÀ DI COLLEGAMENTO AL VEICOLO:

- Con cinghie per il fissaggio a ventose o barre sul tetto
- Con cucitura cava

## LIBELLE

Art. 0106046N

€ tbc  
1/1/-

- 75D Polyester Ripstop
- 250 x 120/250 x H100/230 cm
- Steel Ø 22 mm
- 6 kg









# VANSHELL

## VANSHELL 260

Art. 0106036N

€ tbc  
1 / 5 / 49

 260 x 240 cm

 Fiberglass

 68D 190T PU / Silver 2000 mm

 6 kg

## VANSHELL 300

Art. 0106037N

€ tbc  
1 / 5 / 48

 300 x 240 cm

 Fiberglass

 68D 190T PU / Silver 2000 mm

 6,5 kg

Tendalino parasole per minibus e furgoni con telaio in fibra di vetro, piastra stabilizzatrice centrale e Keder di collegamento per il collegamento al profilo di scorrimento del veicolo. Costruzione molto stabile con leggera curvatura per un ottimale deflusso dell'acqua. Sono compresi 2 pali verticali. Come optional è disponibile un set di pareti laterali adatto ad entrambe le misure.



## OPTIONAL

## VANSHELL SIDEWALL SET

Art. 0106038N

€ tbc  
1 / 10 / -

 240 cm

 68D 190T PU

Set pareti laterali (2 pz.) per tendalino parasole Vanshell. Il set è adatto per entrambe le misure del tendalino. Montaggio semplice e veloce.

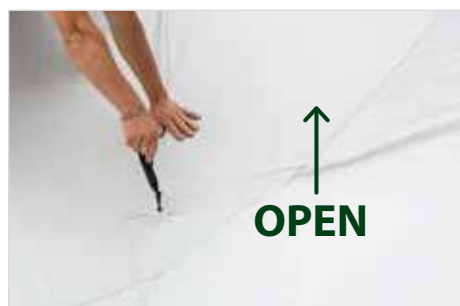



# DEFLECTOR

Comodi tendalini parasole realizzati in materiale sintetico resistente ai raggi UV. Lati bordati e occhiellati. Facili da montare sui profili di scorrimento di caravan, camper, furgonati o minibus. Adatto alle verande Fiamma, Thule e Omnistor.

## DEFLECTOR QDR

Art. 0113065N

€ tbc  
2 / 2 / 33

360 x 360 cm

100% PE

2,5 kg

## DEFLECTOR TRG

Art. 0113063N

€ tbc  
2 / 2 / 50

360 x 360 x 360 cm

100% PE

1 kg

### FIXING KIT SYSTEM INCLUDED

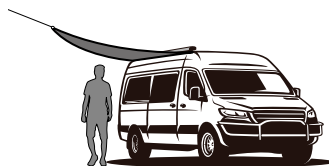
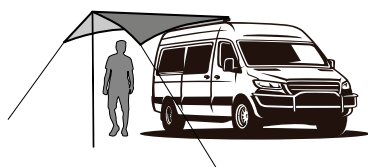
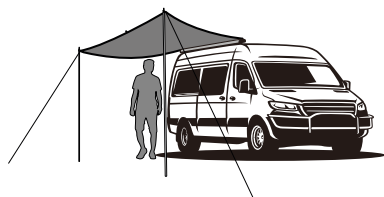

### OPTIONAL

## VERTICAL POLES

Art. 0103004N

€ tbc  
1 / 10 / -

195 x Ø 1,6 cm

PCS. 2X



Acciaio

Pali verticali per tende.

**PTHALATE free**









# SUNNY VIEW



Comodi tendalini parasole realizzati in materiale sintetico resistente ai raggi UV. Lati bordati e occhiellati. Facili da montare sui profili di scorrimento di caravan, camper, furgonati o minibus. Adatto alle verande Fiamma, Thule e Omnistor. Picchetti e cordini sono inclusi nella fornitura.

				M.O.	Master	
Art. 0106040N	290 x H190 cm	1,2 kg	€ tbc	2	2	72
Art. 0106041N	340 x H190 cm	1,4 kg	€ tbc	2	2	60
Art. 0106042N	390 x H190 cm	1,53 kg	€ tbc	2	2	48
Art. 0106039N	240 x H190 cm	1 kg	€ tbc	2	2	-
Art. 0106043N	440 x H190 cm	1,7 kg	€ tbc	2	2	52



## FIXING KIT SYSTEM INCLUDED



## SET TELEPOLE

Art. 0305036N

€ tbc  
1/1/-

 100 - 230 cm

PACK 2X

Palo verticale telescopico in alluminio anodizzato a tre elementi Ø 31/26/21 mm. Con puntale e base.



## OPTIONAL

## VERTICAL POLES

Art. 0103004N

€ tbc  
1/10/-

 195 x Ø 1,6 cm

PCS. 2X

Pali verticali per tende.





# AMADA

Realizzato interamente in tessuto misto cotone/poliestere Pure Pro di alta qualità, il nuovo tettuccio parasole Amada offre un'eccellente protezione dal sole e dalla pioggia con un'elevata stabilità ai raggi UV. Grazie ai tre pali telescopici in alluminio di alta qualità, può essere montato in modo semplice e veloce. Le robuste cinghie di fissaggio consentono un tensionamento perfetto. Facile da montare nell'inferitura per profili keder di caravan, camper, furgoni o bus da campeggio. Adatto verande Fiamma, Thule e Omnistor. Disponibile in 2 misure per veicoli con altezza della grondaia da 180 a 260 cm.

## CARATTERISTICHE:

- Telo parasole e anti-pioggia di alta qualità in tessuto Pure Pro di policotone
- Molto resistente agli strappi e ai raggi UV
- Inclusi tre pali telescopici in alluminio di alta qualità
- Robuste cinghie di fissaggio
- Picchetti in plastica da 30 cm
- Con borsa per il trasporto

## POSSIBILITÀ DI COLLEGAMENTO AL VEICOLO:

- Con doppio profilo keder 5/7 mm

### AMADA 300

Art. 0106047N

€ tbc  
1/1/-

 Polycotton

 Aluminium

 300 x 240 x H100/230 cm

### AMADA 400

Art. 0106048N

€ tbc  
1/1/-

 Polycotton

 Aluminium

 400 x 240 x H100/230 cm







# CARASHADE

Classico telo ombra per caravan con profilo di scorrimento. Completo di pali.

## CARASHADE

 300D Polyester PU

 Steel Ø 22/19 mm

 280 x 200 cm



			M.O.		Master	
Art. 7130237N	280 x 200 cm	€ tbc	1	2	-	
Art. 7130238N	340 x 200 cm	€ tbc	1	2	-	
Art. 7130239N	400 x 200 cm	€ tbc	1	2	-	
Art. 7130189N	200 x 240 cm	€ tbc	1	2	-	
Art. 7130190N	250 x 240 cm	€ tbc	1	2	-	
Art. 7130191N	300 x 240 cm	€ tbc	1	2	-	
Art. 7130192N	350 x 240 cm	€ tbc	1	2	-	
Art. 7130193N	400 x 240 cm	€ tbc	1	2	-	
Art. 7130194N	450 x 240 cm	€ tbc	1	2	-	
Art. 7130246N	260 x 250 cm	€ tbc	1	2	-	
Art. 7130240N	380 x 260 cm	€ tbc	1	2	-	
Art. 7130241N	420 x 260 cm	€ tbc	1	2	-	



# COMPLEMENTS



## QEDER ADAPTER SET

			M.O.	Master	
Art. 7401019N	Ø 5 mm x 3 m	€ tbc	1	10	-
Art. 7401020N	Ø 7 mm x 3 m	€ tbc	1	10	-



Kit per collegare la tenda minibus al veicolo.



## MAGNETIC ADAPTER SET

Art. 7401016N

€ tbc  
4/4/-

3 m

L'adattatore magnetico rappresenta un sistema semplice e pratico per collegarsi a veicoli sprovvisti di canalina. Aderisce perfettamente ai tetti piatti in lamiera di acciaio.

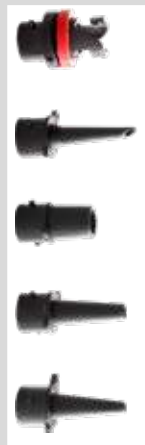

## WHISPER ALU

Art. 0436002N

€ tbc  
6/6/-

- 1x 3000 CC
- 10 x 22 x 54 cm
- 1,2 kg

Pompa aria con pistone in alluminio e set adattatori.





## CAPTURE

Art. 0102988N

Ø 5,4 cm

120 g



## ATACO

Art. 0102985N

Ø 11,5 cm

2x 238 g



## FLAPLOCK

Art. 0301314N

120 x 45 mm

95 g



Ventosa per tenda per minibus con corpo in metallo. Set 2 pz.

Set di ventose con anello a D per il fissaggio senza viti di tendalini parasole, tende per minibus, teloni e molto altro ancora su superfici lisce. Possono essere caricate fino a max 12 kg. Set 2 pz.

Morsetto stabilizzante per tende e verande. Riduce fortemente l'eventualità di danni al tessuto in caso di forte vento. Corpo in materiale plastico. Set 2 pz.



## STABILIZER KIT

Art. 0301311N

1,2 kg



## STABILIZER KIT UNIVERSAL

Art. 0301315N

1,2 kg



## PROP

Art. 0301312N

1,2 kg



Cinghia stabilizzante per verande camper e caravan in caso di vento. Il kit comprende: 1 nastro stabilizzatore (13 m) con molla di tensione e grandi picchetti di ancoraggio.

Kit cinghie stabilizzanti per verande caravan. Adatto per la maggior parte delle verande di produzione europea con fibbie premontate. Il set comprende 2 robusti picchetti di ancoraggio, 2 molle di scarico tensione e 2 cinghie di sicurezza.

Sistema stabilizzante per verande e tendalini parasole. Il set è dotato di 2 fibbie (2x 50cm+3m) e 2 picchetti robusti (2x 30cm). Pratica sacca custodia inclusa.



# UN CUCINOTTO PER TUTTE LE OCCASIONI



**I cucinotti hanno principalmente la funzione di una cucina mobile. Offrono anche numerosi vantaggi aggiuntivi che rendono il campeggio più facile e sono particolarmente apprezzati dalle famiglie:**

- Più spazio e libertà di movimento nella veranda
- Nessun odore di cucina sgradevole nella veranda
- Ottima ventilazione
- Confortevole altezza interna
- Può essere usato anche come tenda Storage (si consiglia con catino)
- Perfetto per riporre in sicurezza biciclette, moto, grill o giocattoli per bambini
- Alcuni modelli sono disponibili con catino integrato o integrabile (vedi descrizione del prodotto)

Per coloro che apprezzano l'ordine e l'organizzazione consigliamo sempre l'utilizzo di un cucinotto o di una tenda Storage. La nostra gamma comprende una varietà di modelli e dimensioni progettati per diverse applicazioni. Leggere attentamente le descrizioni dei prodotti corrispondenti per selezionare il modello più adatto alle proprie esigenze.







## CHEF II OUTDOOR

Art. 0426041N

€ tbc  
1/1/20

 Polyester UV resistant 100% Polyester

 200 x 200 x H190/230 cm

 Fiberglass / Steel

 11,6 kg

 76 x Ø 23 cm

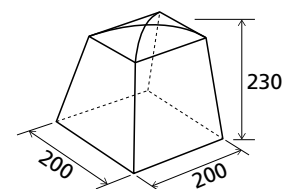

**Cucinotto moderno realizzato con materiali leggeri.**

### CARATTERISTICHE:

- 3 finestre a zanzariera con copertura
- Entrata apribile a veranda
- Aerazione in sommità di cupola
- Balza perimetrale
- Completo di sacca custodia, pali verticali e accessori di montaggio





## DINERY

Art. 0425994N

€ tbc  
1/1/-

 Polyester PU 100% Polyester

 240 x 240 x H190/230 cm

 Fiberglass / Steel

 16,7 kg

 80 x Ø 28 cm

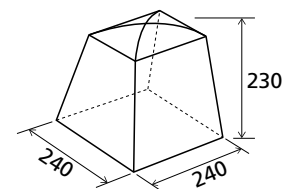

TITANIUM AXIA  
P. 210



CRUISER  
P. 193



MERCURY CROSS  
COOKER  
P. 229

Tenda multiuso per cucina ed attrezzatura con un robusto telaio in acciaio/fibra di vetro, grandi finestre e una porta d'ingresso ad avvolgimento. Con balza perimetrale. Sono inclusi il materiale di montaggio e la sacca custodia.

MIX &  
MATCH



# VIDA

**Cucinotto con classico tetto a falde.**

**CARATTERISTICHE:**

- Porta d'entrata arrotolabile lateralmente
- 3 grandi finestre a zanzariera con copertura
- Apertura di aerazione
- Con balza rialzata
- Completo di sacca custodia e accessori di montaggio



## VIDA I NG

Art. 0425998N.C30

€ tbc  
1 / 1 / 15

PVC / Polyester / Oxford

200 x 150 x H195/215 cm

Steel Ø 19 mm

13,5 kg

100 x 21 x 26 cm

## VIDA II NG

Art. 0425999N.C30

€ tbc  
1 / 1 / 15

PVC / Polyester / Oxford

200 x 200 x H195/215 cm

Steel Ø 19 mm

16,5 kg

100 x 21 x 26 cm

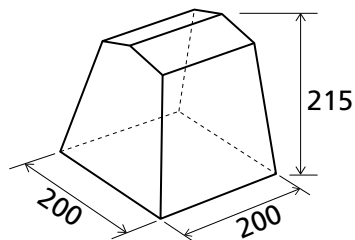
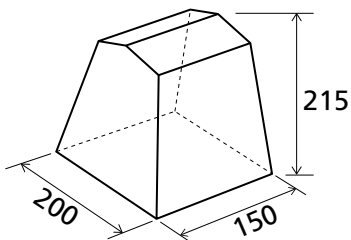





# GUSTO

**Cucinotto con classico tetto a falde.**

**CARATTERISTICHE:**

- Finestre a zanzariera con copertura
- Balza perimetrale
- Con porta ingrandita e finestre supplementari entrata luce
- Completo di sacca custodia e accessori di montaggio





## GUSTO I NG

Art. 0425995N

€ tbc  
1/1/15

 PVC / Polyester / Oxford PVC

 150 x 150 x H195/215 cm

 Steel Ø 19 mm

 11,7 kg

 100 x 21 x 25 cm

 **COLORS**  
AMBEL READY LIGHT SYSTEM C25 C30

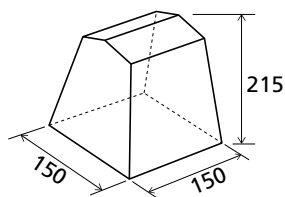

## GUSTO II NG

Art. 0425996N

€ tbc  
1/1/15

 PVC / Polyester / Oxford PVC

 200 x 150 x H195/215 cm

 Steel Ø 19 mm

 13,5 kg

 100 x 21 x 26 cm

 **COLORS**  
AMBEL READY LIGHT SYSTEM C25 C30

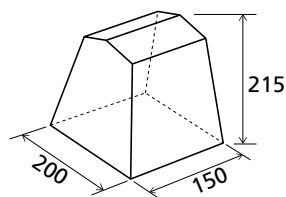

## GUSTO III NG

Art. 0425997N

€ tbc  
1/1/15

 PVC / Polyester / Oxford PVC

 200 x 200 x H195/215 cm

 Steel Ø 19 mm

 16,5 kg

 100 x 21 x 26 cm

 **COLORS**  
AMBEL READY LIGHT SYSTEM C25 C30

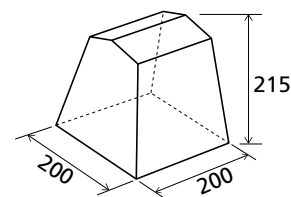



# CAMP INN

Moderno cucinotto multiuso. Design innovativo con tetto arcuato in poliesteresalmato su entrambi i lati (PVC).

## CARATTERISTICHE:

- Pareti laterali e posteriori con grandi finestre di ventilazione in zanzariera con telo di copertura
- Parete anteriore con porta arrotolabile lateralmente
- Apertura di ventilazione permanente
- Con balza perimetrale
- Completo di sacca custodia e accessori di montaggio

## CAMP INN

Art. 0426013N

€ tbc  
1 / 1 / 12

 PVC / Polyester / Oxford PVC

 220 x 160 x H195/220 cm

 Steel Ø 22 mm

 19,5 kg

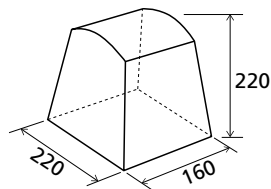

# MIX & MATCH



SPECTRACOOOL 25  
P. 350



VINIS FOLD-AWAY  
p. 332



SKIPPER  
p. 306



MIDDAY DEEP SEA  
p. 268





# CORIANDER

Tenda multifunzione di nuova concezione. Funge perfettamente da tenda cucina e da ripostiglio per la protezione di tutte le attrezzature che non possono essere lasciate all'aperto. L'intera tenda è realizzata in PVC ed è sostenuta da un robusto telaio in acciaio. Tre grandi finestre con zanzariera e un'efficiente ventilazione del tetto garantiscono un'ottima aerazione. Con ampia porta d'ingresso arrotolabile lateralmente. Con balza perimetrale. Incl. accessori e sacca custodia.

## CORIANDER I

Art. 0425991N.C06

€ tbc  
1/1/12



PVC



200 x 150 x H195/210 cm



Steel Ø 22 mm



20,5 kg

## CORIANDER II

Art. 0425992N.C06

€ tbc  
1/1/12



PVC



200 x 200 x H195/210 cm



Steel Ø 22 mm



23 kg

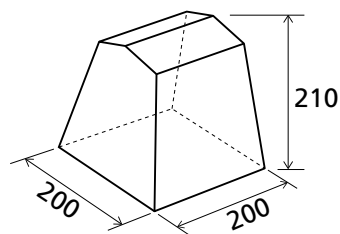
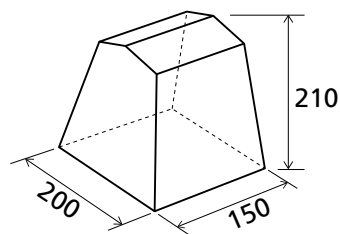



# CABINA

Pratica tenda cabina per campeggio e spiaggia. Ideale per la doccia e cambiarsi, ma anche come tenda cucina.

## CARATTERISTICHE:

- Porta con cerniera
- Grande finestra posteriore
- Balza perimetrale
- Con sacca custodia ed accessori di montaggio

## CABINA II NG

Art. 0102028N

€ tbc  
4 / 4 / 80

 Polyester UV resistant 100% Polyester

 140 x 140 x H205 cm

 Fiberglass

 2,65 kg

 67 x Ø 23 cm

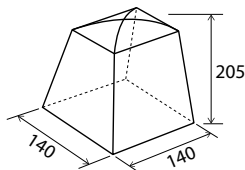

## CABINA MAXI NG

Art. 0102029N

€ tbc  
4 / 4 / 80

 Polyester UV resistant 100% Polyester

 180 x 160 x H205 cm

 Fiberglass

 4 kg

 70 x Ø 27 cm

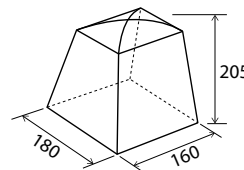





# SANITY

Tenda sanitaria versatile e polivalente con pali stabili in acciaio, pavimento rimovibile e finestra di zanzariera richiudibile. Sono comprese varie soluzioni funzionali ed una pratica borsa da trasporto.





# STORAGE PLUS

Pratica tenda per attrezzi con tetto a 2 falde, ideale per il campeggiatore ben accessorio. Robusta, con catino saldamente cucito. L'ampia porta d'ingresso sul lato anteriore può essere comodamente aperta tramite due cerniere e, se necessario, essere aperta come tettuccio parasole. La parete posteriore è dotata di un'ampia finestra a zanzariera che può essere chiusa mediante una pellicola in Crystal. 3 aperture di ventilazione sulla parete anteriore e laterali garantiscono una sufficiente circolazione dell'aria all'interno della tenda. Materiale di montaggio incluso.

## SANITY

Art. 0102025N

€ tbc  
2 / 4 / 30



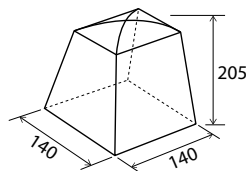

-  68D Polyester PU (100% Polyester)
-  140 x 140 x H205 cm
-  Steel Ø 16 mm
-  6 kg
-  80 x 41 cm



## STORAGE PLUS

Art. 0426044N.C06

€ tbc  
1 / 1 / 12

-  PVC / Oxford Polyester
-  225 x 160 x H175/195 cm
-  Steel Ø 19 mm
-  13,9 kg
-  94,5 x 22 x 28 cm

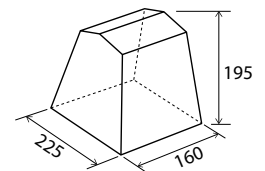

Info p. 368

ON-OFF DIMMER  
0-100%



Energy class  
in process of approval



220V



12V



Energy class  
in process of approval









12V



220V

## OPTIONAL

									M.O.	Master	
<b>AMBEL COMPACT</b>	Art. 7530026N	50 x 2 x 1,5 cm	125 g	12V DC - 220V AC	500 lumen	30	7W	€ tbc	6	12	-
<b>AMBELL</b>	Art. 7530027N	120,5 x 2,8 x 2,4 cm	468 g	12V DC - 220V AC	1100 lumen	180	12W	€ tbc	6	18	-

La versione compatta della lampada Ambel L.

Lampada tubolare LED per verande e gazebo. Montaggio ai pali della struttura mediante clips in plastica Ø 22-26 mm.



**a.i.r. tech**  
air inflation raising

100% Polyester  
190T

# AQUAMAR

**Gazebo outdoor gonfiabile realizzato con tecnologia Crossbeam.**

**CARATTERISTICHE:**

- Semplice e rapido da montare e smontare
- Aste di stabilizzazione sui 4 lati
- Altezza interna 2 metri
- Pompa a doppia azione inclusa
- Sacca custodia inclusa
- Accessori di montaggio inclusi
- Set pareti laterali (2 pz.) disponibile come optional

## AQUAMAR

Art. 0102004N.C70

€ tbc  
1 / 1 / 20

 190T Polyester 75D Polyester PU

 AIRTUBE

 300 x 300 x H190/220 cm

 13,6 kg

 75 x Ø 29 cm



### OPTIONAL

## AQUAMAR SIDEWALL SET

Art. 0102015N.C70

€ tbc  
2 / 10 / -

 100% Polyester

Set di due pareti laterali per gazebo Aquamar.







## PROTEZIONE DAL SOLE





È arrivata l'ora del divertimento al sole ed all'aria aperta. Divertimento da affrontare sempre in sicurezza e ben protetti dai potenzialmente pericolosi raggi UV. Sia che vi stiate godendo una giornata di sole in giardino o a bordo piscina o sulla spiaggia, i prodotti per la protezione dal sole Brunner sono gli accessori giusti da usare. Progettati per essere leggeri e facilmente trasportabili, quasi tutti vantano un fattore di protezione UV 50+ ideale per mantenere la pelle fresca e ben protetta. Brunner è da sempre sinonimo di design funzionale ed innovazione creativa. Tutti i prodotti vengono sviluppati e realizzati con la passione per una vita da trascorrere all'aria aperta. Il nostro obiettivo è sempre quello di offrire attrezzatura di elevata qualità che combini il meglio della convenienza, della funzionalità e del design, per fornire una protezione efficace dal sole, dal vento o dalla pioggia.



### DIADEM

Art. 0102005N.C06

€ tbc  
1 / 1 / 20

-  Polyester PU 100% Polyester
-  Steel Ø 19 mm
-  320 x 320 x H180/215 cm
-  12,1 kg
-  105 x Ø 17 cm

Gazebo Outdoor con struttura in acciaio. Ottima protezione dal sole.



### OPTIONAL

### DIADEM SIDEWALL SET

Art. 0102001N.C06

€ tbc  
2 / 10 / -

-  100% Polyester





Set di due pareti laterali per gazebo Diadem.



### OCEANA

Art. 0102013N

€ tbc  
1 / 1 / -

-  190T 68D PU / Silver PU2000 mm
-  Fiberglass
-  300 x 300 x H220 cm
-  9,2 kg
-  78 x Ø 18 cm

L'Oceana è un gazebo outdoor di nuova concezione, di grande impatto visivo e di ottima stabilità. E' ideale per qualsiasi incontro di gruppo, dal minibus camping, al soggiorno in spiaggia, al barbecue in giardino. La speciale forma del tetto protegge dal sole e dalla pioggia anche tutta l'attrezzatura. L'Oceana viene fornito con tutto il necessario per il suo utilizzo: pali in fibra di vetro, picchetti, corde tensione ed una sacca custodia. Sono incluse 2 pareti laterali. La stuoia per il pavimento è opzionale.



### OPTIONAL

### OCEANA SIDEWALL SET

Art. 0102014N

€ tbc  
2 / 10 / -

-  300 x 300 cm

Set di pareti laterali (2 pz.) per gazebo outdoor Oceana. Con borsa per il trasporto.



# MEDUSA II

## INFO

### IL FATTORE DI PROTEZIONE UV

Il fattore di protezione indica il livello di protezione UV dei vari tessuti. Esistono numerose similitudini con il sistema SPF che indica il livello di protezione di creme solari. Tessuti con un fattore di protezione UV 50+ permettono il passaggio di appena 1/50 della radiazione. Ciò significa che il 98% dei raggi UV viene bloccato.

### MEDUSA II 3X3

Art. 0102034N

€ tbc  
1 / 1 / 25

68D Polyester PU 100% Polyester

Fiberglass / Steel

300 x 300 x H190/230 cm

10 kg

62 x Ø 23 cm

#### COLORS



Gazebo per outdoor con paleria esterna in acciaio e fibra di vetro. Completo di due pareti laterali staccabili.



### OPTIONAL

### MEDUSA SIDEWALL SET 300

Art. 0102057N

€ tbc  
2 / 10 / 240

100% Polyester

300 x H178 cm

Set di due pareti laterali per gazebo Medusa.





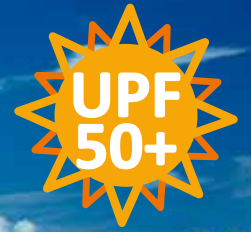



100% Polyester  
68D Polyester PU

## MEDUSA II 4X4

Art. 0102030N

€ tbc  
1 / 1 / 25

 68D Polyester PU 100% Polyester

 Fiberglass / Steel

 400 x 400 x H190/230 cm

 12,2 kg

 69 x Ø 25 cm

### COLORS



Gazebo Outdoor con paleria esterna in acciaio e fibra di vetro. Completo di due pareti laterali staccabili.



### OPTIONAL

## MEDUSA SIDEWALL SET 400

Art. 0102055N

€ tbc  
2 / 10 / 150

 100% Polyester

 400 x H178 cm

Set di due pareti laterali per gazebo Medusa.



3 SIDES WITH MESH

## BAYOU

Art. 0113039N

€ tbc  
5 / 10 / -

100% Polyester

PE

Fiberglass

245 x 150 x H100 cm

1,2 kg

2 x Ø 75 cm



Conchiglia parasole con sistema Pop Up. Offre spazio sufficiente per 2 persone. Gli accessori di montaggio sono inclusi.



## UMBRA

Art. 0113040N

€ tbc  
6 / 6 / -

100% Polyester

PE

Fiberglass

200 x 150 x H130 cm

1,9 kg

59 x Ø 12 cm



Moderna conchiglia parasole con spazio per 2-3 persone. Con accessori di montaggio e sacca custodia.



# TONGA

## TONGA

Art. 0113016N

€ tbc  
6 / 6 / -

100% Polyester

PE

Fiberglass

240 x 110 x H155 cm

1,35 kg

53 x Ø 9 cm



Conchiglia parasole che protegge da vento, sabbia e sguardi indiscreti. Catino fissato mediante cucitura. Sacca custodia inclusa.





**PAGODA**

Art. 0102023N.C30

€ tbc  
4 / 4 / 48

- 68D Polyester PU/Alu 100% Polyester
- Fiberglass
- 300 x 300 x H195 cm
- 4,3 kg
- 61 x Ø 15 cm

Stabile gazebo parasole con paleria in fibra di vetro. Protegge da sole, pioggia e vento. Sono incluse due pareti laterali.



**OPTIONAL**

**PAGODA SIDEWALL SET**

Art. 0102024N

€ tbc  
2 / 12 / -

- 100% Polyester

Set di due pareti laterali per il gazebo parasole Pagoda. Fissaggio delle pareti tramite velcro.

**SUNTOP**

Art. 0113049N

€ tbc  
3 / 9 / 180

- 100% Polyester
- Fiberglass
- 250/150 x 190 x H150 cm
- 1,68 kg
- 63 x Ø 12 cm



**Conchiglia parasole di grandi dimensioni.**

**CARATTERISTICHE:**

- Unisce i vantaggi di una conchiglia parasole con quelli di un ombrellone
- Le pareti laterali rialzate garantiscono una buona ventilazione
- Montaggio e smontaggio semplici e rapidi
- Con pratica borsa per il trasporto

**SUNNY UV**

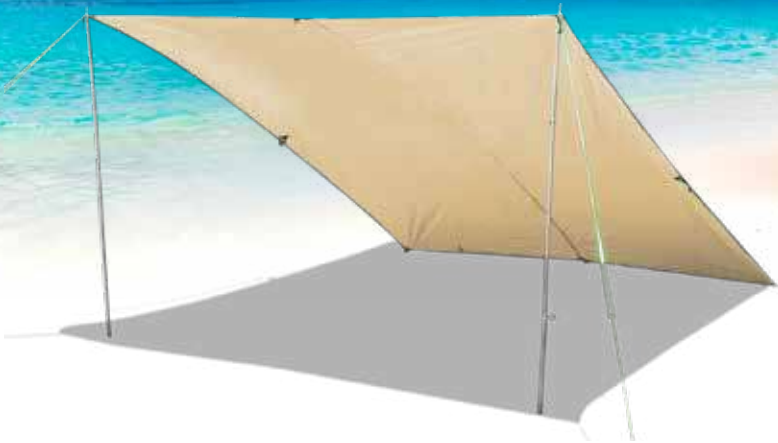

						€ tbc	M.O.	Master	
SUNNY UV	Art. 0113055N	Steel Ø 19 mm	2 x 3 m	1,84 kg	100% Polyester	€ tbc	2	10	120
SUNNY UV	Art. 0113056N	Steel Ø 19 mm	3 x 3 m	2,02 kg	100% Polyester	€ tbc	2	10	120
SUNNY UV	Art. 0113057N	Steel Ø 19 mm	3 x 4 m	2,30 kg	100% Polyester	€ tbc	2	10	120

Utilissima vela parasole con numerose varianti di montaggio. La fornitura comprende 2 pali verticali in acciaio.



# BARRIER

Paravento ideale per l'uso in campeggio o in giardino. Stabile e di alta qualità, con quattro pali verticali e tre aste orizzontali di stabilizzazione in acciaio Ø 22 mm.

## BARRIER 400

Art. 0113001N

€ tbc  
4 / 4 / 60

 H140 x 400 cm

 81 x 16 x 16 cm

 5,52 kg

 100% Polyester

## BARRIER 600

Art. 0113002N

€ tbc  
4 / 4 / 60

 H140 x 600 cm

 81 x 16 x 16 cm

 6,6 kg

 100% Polyester



# LAOLA

Paravento da spiaggia. Sono compresi picchetti, corde tensione ed una sacca custodia.

## LAOLA

Art. 0113047N

€ tbc  
4 / 8 / 144

 H115 x 400/520 cm

 64 x Ø 11 cm

 1,6 kg

 100% Polyester







# PANAMA

Telo paravento con finestrella panoramica in plastica trasparente.

## PANAMA SKY 400

Art. 0113058N.C30

€ tbc  
4 / 4 / -

	H140 x 400 cm
	90 x 25 x 5 cm
	2,5 kg
	100% PE

## PANAMA SKY 600

Art. 0113059N.C30

€ tbc  
4 / 4 / -

	H140 x 600 cm
	90 x 25 x 5 cm
	3,3 kg
	100% PE



# BAHAMAMA

Paravento da spiaggia dai colori vivaci. Viene fornito con materiale di montaggio ed una pratica sacca custodia.

## BAHAMAMA TNT

Art. 0113048N

€ tbc  
6 / 12 / 120

	H110 x 480 cm
	H118 x 18 cm
	1,1 kg
	TNT

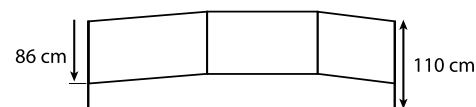





# GAZEBOS & BEACH PARASOLS

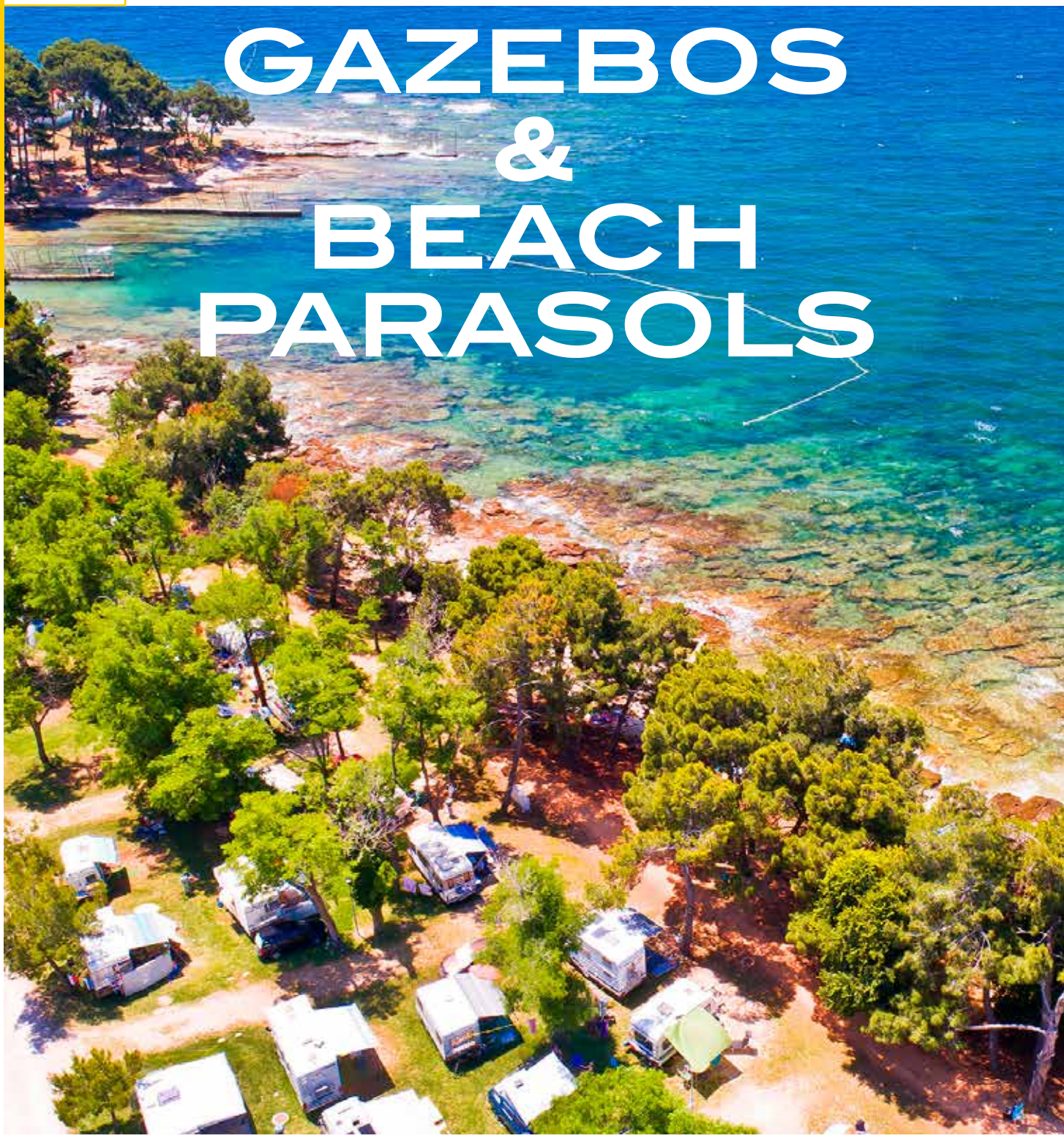

**GAZEBI AUTOMATICI  
OMBRELLONI**



# ZEBÒ COLLECTION

Gazebo pieghevoli Zebò per il tempo libero, per il camping, per gli eventi e per la vendita.

Da oltre 20 anni la nostra gamma di prodotti comprende gazebo pieghevoli di alta qualità per le più svariate attività. In questo lasso di tempo, il nostro team di sviluppo prodotto ha sempre cercato di migliorare i materiali e la relativa produzione. Tutti i materiali sono accuratamente selezionati e testati in condizioni reali per soddisfare le aspettative del cliente e garantire l'affidabilità e la durata desiderata.

I gazebo pieghevoli Zebò sono particolarmente apprezzati nel settore del tempo libero e del campeggio, ma sono anche ideali per eventi, presentazioni o feste. Sono facili e veloci da montare e smontare e possono essere riposti in modo

compatto e comodamente trasportati.

Importante: tutti i componenti sono avvitati insieme per facilitarne la manutenzione e possono quindi essere facilmente sostituiti.

La collezione di gazebo pieghevoli Zebò comprende i seguenti modelli:

- Zebò Enjoy 2.0 - Robusti gazebo pieghevoli con telaio in acciaio verniciato a polvere (profilo rettangolare 40x40 mm). Disponibile in 3 misure.

- Zebò Enjoy PRO - Gazebo PRO pieghevole in alluminio di alta qualità, con struttura a profilo esagonale da 50 mm. Disponibile in 3 misure.



COLLECTION	ZEBÒ ENJOY	ZEBÒ ENJOY	ZEBÒ ENJOY	ZEBÒ ENJOY	ZEBÒ ENJOY	ZEBÒ ENJOY
	2.0 3x3	2.0 3x4,5	2.0 3x6	PRO 3x3	PRO 3x4,5	PRO 3x6
Struttura pieghevole automatica	•	•	•	•	•	•
Struttura ad innesto	-	-	-	-	-	-
Struttura in acciaio	•	•	•	-	-	-
Struttura in alluminio	-	-	-	•	•	•
Palo tetto centrale	•	•	•	•	•	•
Struttura regolabile in altezza	•	•	•	•	•	•
Componenti struttura avvitati	•	•	•	•	•	•
Snodi rinforzati	•	•	•	•	•	•
Tessuto tetto in poliesteri	•	•	•	•	•	•
Tessuto tetto in PE	-	-	-	-	-	-
Cuciture nastrate	•	•	•	•	•	•
Punti di contatto tetto/struttura rinforzati	•	•	•	•	•	•
Spalmatura tetto in PVC	•	•	•	•	•	•
Varianti colore	1	1	1	1	1	1
Pareti laterali optional	•	•	•	•	•	•
Accessori di montaggio inclusi	•	•	•	•	•	•



# ZEBÒ ENJOY 2.0



Snodi di alta qualità



Cinghia di fissaggio



Nastro premi e chiudi per fissaggio pareti



Gambe regolabili in altezza

Pratico gazebo automatico con palo centrale per una massima inclinazione del tetto che favorisce il deflusso dell'acqua. Stabile struttura in profili di acciaio verniciato a polvere con gambe regolabili in altezza. Tetto realizzato in 100% poliestere a spalmatura impermeabile. Cuciture nastrate. La fornitura comprende una pratica borsa per il trasporto munita di ruote. Sono inclusi tiranti e picchetti.

Montaggio e smontaggio semplice e rapido. Campi d'utilizzo: Camping, feste ed eventi, fiere.

#### CARATTERISTICHE:

- Tipo struttura: automatica-pieghevole
- Gambe: in acciaio verniciato a polvere 40x40 mm, regolabili in altezza
- Tutti i componenti sono avvitati e sostituibili







**ZEBÒ ENJOY 2.0  
3X3**

Art. 0102211N.C00

€ tbc  
1/1/12

3 x 3 x 2,10/3,35 m

155 x 24 x 24 cm

100% Polyester / PVC 290 g/m2

40x40/35x35/15x30 mm

25,5 kg



**ZEBÒ ENJOY 2.0  
3X4,5**

Art. 0102212N.C00

€ tbc  
1/1/9

3 x 4,5 x 2,10/3,35 m

155 x 32 x 22 cm

100% Polyester / PVC 290 g/m2

40x40/35x35/15x30 mm

32,2 kg



**ZEBÒ ENJOY 2.0  
3X6**

Art. 0102213N.C00

€ tbc  
1/1/7

3 x 6 x 2,10/3,35 m

155 x 42 x 22 cm

100% Polyester / PVC 290 g/m2

40x40/35x35/15x30 mm

43,7 kg





# ZEBÒ ENJOY PRO



Snodi di alta qualità



Cinghia di fissaggio



Nastro premi e chiudi per fissaggio pareti



Gambe regolabili in altezza

**Gazebo automatico semiprofessionale con struttura esagonale di alta qualità. Dotato di palo centrale per una massima inclinazione del tetto che favorisce il deflusso dell'acqua. Struttura molto stabile in alluminio con gambe regolabili in altezza. Tetto realizzato in 100% poliestere a spalmatura impermeabile. Cuciture nastrate. La fornitura comprende una pratica borsa per il trasporto munita di ruote. Sono inclusi tiranti e picchetti. Montaggio e smontaggio semplice e rapido. Campi d'utilizzo: Feste ed eventi, mercatini, fiere.**

#### CARATTERISTICHE:

- Tipo struttura: automatica-pieghevole
- Gambe: in alluminio 50 mm, regolabili in altezza
- Spessore profili: gambe 2,0 mm - tetto 2,0 mm
- Tutti i componenti sono avvitati e sostituibili







## ZEBÒ ENJOY PRO 3X3

Art. 0102221N.C00

€ tbc  
1 / 1 / 12

3 x 3 x 2,10/3,35 m

158 x 25 x 25 cm

100% Polyester / PVC 290 g/m2

50/45/32x16 mm

22,5 kg



## ZEBÒ ENJOY PRO 3X4,5

Art. 0102222N.C00

€ tbc  
1 / 1 / 9

3 x 4,5 x 2,10/3,35 m

158 x 32 x 24 cm

100% Polyester / PVC 290 g/m2

50/45/32x16 mm

28,7 kg



## ZEBÒ ENJOY PRO 3X6

Art. 0102223N.C00

€ tbc  
1 / 1 / 7

3 x 6 x 2,10/3,35 m

158 x 42 x 24 cm

100% Polyester / PVC 290 g/m2

50/45/32x16 mm

38,2 kg



### OPTIONAL

## SIDEWALL SET ZEBÒ ENJOY 2.0 / PRO

Utilissimo set di pareti laterali per gazebo pieghevoli ZEBÒ ENJOY 2.0 e ENJOY PRO.

Le pareti laterali completano ogni gazebo pieghevole e lo rendono resistente alle intemperie e al vento. Tutte le pareti laterali vengono semplicemente fissate all'interno del bordo del gazebo tramite nastro premi e strappa già predisposto e collegabili mediante l'ausilio di cerniere. Nella fornitura è compresa una borsa custodia.

Art. 0102215N.C00

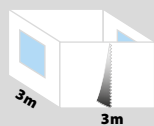

Art. 0102216N.C00

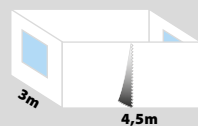

Art. 0102217N.C00

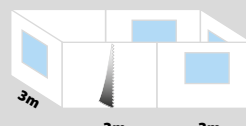

M.O.

Master



Art.	Size	Material	Weight	€ tbc	M.O.	Master
Art. 0102215N.C00	3 x 3 m	210 PU Polyester	8,5 kg	€ tbc	1	4 40
Art. 0102216N.C00	3 x 4,5 m	210 PU Polyester	10,6 kg	€ tbc	1	4 36
Art. 0102217N.C00	3 x 6 m	210 PU Polyester	12,8 kg	€ tbc	1	4 28



## BASE

Art. 0303064N

€ tbc  
8 / 16 / 48

Ø 25 cm

1,3 kg

### COLORS



Base stabilizzante in materiale plastico. Per gazebo con gambe da Ø 25 a 32 mm. Viene fornita in coppia.



## BALLAST NG

Art. 0303078N

€ tbc  
1 / 1 / -

10 kg

Zavorra in ghisa per la stabilizzazione delle singole gambe dei gazebo. Con cinghia di fissaggio. Adatto per profili fino a 40x40 mm.



# SOLADO

## SOLADO

Art. 0113013N

€ tbc  
6 / 6 / 72

Moderno ombrellone da sole e da spiaggia di dimensioni compatte. Dotato di stelo in alluminio e di un robusto telo resistente ai raggi UV. I passanti aggiuntivi alle estremità dei raggi dell'ombrellone permettono l'ancoraggio contro il forte vento. Nella parte inferiore dell'ombrellone ci sono 2 ganci e una pratica rete per gli utensili. Grazie all'inclinazione laterale regolabile, questo ombrellone offre la migliore protezione solare in qualsiasi momento della giornata. Borsa per il trasporto inclusa.

 Ø 200 x H220 cm

 120 x 12 cm

 100% Polyester

 2,52 kg

 Aluminium

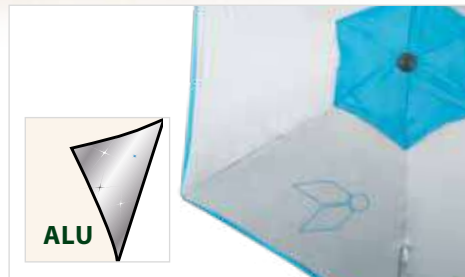

ALU



included

## INFO

### PROTEZIONE DAL SOLE

È arrivata l'ora del divertimento al sole ed all'aria aperta. Divertimento da affrontare sempre in sicurezza e ben protetti dai potenzialmente pericolosi raggi UV. Sia che vi stiate godendo una giornata di sole in giardino o a bordo piscina o sulla spiaggia, i prodotti per la protezione dal sole Brunner sono gli accessori giusti da usare. Progettati per essere leggeri e facilmente trasportabili, quasi tutti vantano un fattore di protezione UV 50+ ideale per mantenere la pelle fresca e ben protetta. Brunner è da

sempre sinonimo di design funzionale ed innovazione creativa. Tutti i prodotti vengono sviluppati e realizzati con la passione per una vita da trascorrere all'aria aperta. Il nostro obiettivo è sempre quello di offrire attrezzatura di elevata qualità che combini il meglio della convenienza, della funzionalità e del design, per fornire una protezione efficace dal sole, dal vento o dalla pioggia.





# ONDA PARSOL

## ONDA PARSOL

Art. 0113017N

€ tbc  
6/6/-
 205/200 x H220 cm

 123 x 13 cm

 Polyester 180g

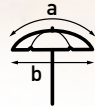
 2 kg

**a: 205 cm**  
**b: 200 cm**

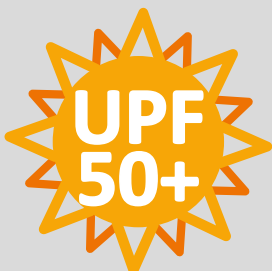
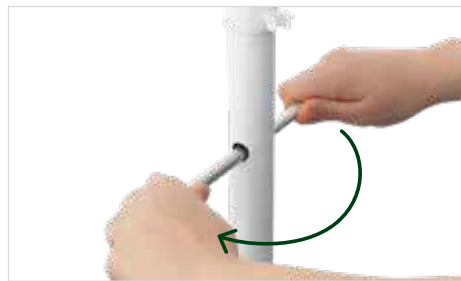
Moderno ombrellone realizzato in resistente tessuto sintetico e struttura molto stabile a 6 raggi. Stelo molto robusto in acciaio verniciato a polvere Ø 32 mm con snodo in alluminio e puntale a vite per terreni sabbiosi. Ottima resistenza al vento grazie al soffietto di scarico integrato. Con borsa per il trasporto.



## IL FATTORE DI PROTEZIONE UV

Il fattore di protezione indica il livello di protezione UV dei vari tessuti. Esistono numerose similitudini con il sistema SPF che indica il livello di protezione di creme solari. Tessuti con un fattore di protezione UV 50+ permettono il passaggio di appena 1/50 della radiazione. Ciò significa che il 98% dei raggi UV viene bloccato.



# BEACH PARASOL



## BEACH PARASOL

Art. 0113009N.C08

€ tbc  
6/6/-

- Ø 140 x H140 cm
- 100% Polyester
- Alu / Fiberglass

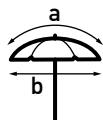

a: 155 cm  
b: 140 cm

## BEACH PARASOL XL

Art. 0113010N.C08

€ tbc  
6/6/-

- Ø 175 x H160 cm
- 100% Polyester
- Alu / Fiberglass

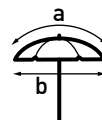

a: 195 cm  
b: 175 cm

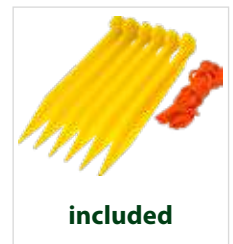
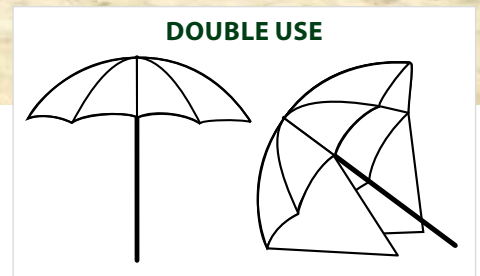

Ombrellone predisposto per l'applicazione di pareti laterali che lo trasformano in una praticissima conchiglia parasole.

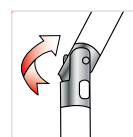

## SUN PARASOL 180

Art. 0113025N

€ tbc  
6/6/-

- Ø 180/160 x H198 cm
- Ø 9 x H107 cm
- 100% PES
- 1,6 kg

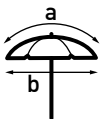

a: 180 cm  
b: 160 cm

## SUN PARASOL 200

Art. 0113026N

€ tbc  
6/6/-

- Ø 200/190 x H198 cm
- Ø 9 x H107 cm
- 100% PES
- 1,8 kg

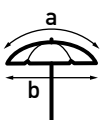

a: 200 cm  
b: 180 cm



Ombrellone di alta qualità da giardino e spiaggia.







## PARSOL RIDE2SEA 180

Art. 0113028N.C9N

€ tbc  
6/6/-

- Ø 180/160 x H190 cm
- 64 x 20 x 7 cm
- Polyester / Alu
- 1,48 kg
- Steel Ø 25 mm

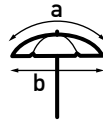

a: 180 cm  
b: 160 cm

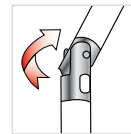

Ombrellone parasole supercompatto. Grazie al suo speciale sistema di montaggio non supera i 64 cm di lunghezza quando smontato.



### RIO

Art. 0303043N

€ tbc  
12 / 48 / -

39 cm x Ø 13/33 mm

Picchetto portaombrelloni realizzato in robusto materiale plastico. Con adattatore per steli da 13 a 33 mm.



### DRILLER

Art. 0303044N

€ tbc  
10 / 20 / -

32,5 cm x Ø 13/33 mm

Picchetto portaombrelloni avvitabile per terreni sabbiosi. Con manico e vite di fissaggio per l'ombrellone. Realizzato in resistente materiale plastico.



### WAIKIKI BASIC

Art. 0303046N

€ tbc  
10 / 20 / -

45 cm Ø tube 36 mm

Picchetto portaombrelloni in acciaio zincato.



# CAMPING ACCESSORIES



**PALERIA ED ACCESSORI TENDE  
TELONI ED ACCESSORI**





## PICCHETTI



La maggior parte delle tende in commercio viene offerta con picchetti standard. In modo che la vostra tenda si possa fissare adeguatamente su ogni tipo di suolo e con ogni condizione meteorologica è sempre consigliato adattare l'assortimento di picchetti.



# PER TERRENI MISTI

## TEMPEST





		PACK		M.O.	Master	
Art. 0303010C	20 cm	6X	€ tbc	20	60	-
Art. 0303010N	20 cm		€ tbc	100	100	-
Art. 0303011C	25 cm	6X	€ tbc	20	60	-
Art. 0303011N	25 cm		€ tbc	100	100	-
Art. 0303012C	30 cm	6X	€ tbc	20	60	-
Art. 0303012N	30 cm		€ tbc	100	100	-

Picchetto in acciaio zincato.

## THOR





		PACK		M.O.	Master	
Art. 0303028C	18 cm	5X	€ tbc	10	50	-
Art. 0303028N	18 cm		€ tbc	100	100	-
Art. 0303029C	23 cm	5X	€ tbc	10	50	-
Art. 0303029N	23 cm		€ tbc	100	100	-
Art. 0303030C	27 cm	5X	€ tbc	10	50	-
Art. 0303030N	27 cm		€ tbc	100	100	-

Picchetto in acciaio zincato.

## DRAGON



		PACK		M.O.	Master	
Art. 0303035C	20 cm	6X	€ tbc	10	50	-
Art. 0303035N	20 cm		€ tbc	100	100	-
Art. 0303036C	25 cm	6X	€ tbc	10	50	-
Art. 0303036N	25 cm		€ tbc	100	100	-
Art. 0303037C	30 cm	6X	€ tbc	10	50	-
Art. 0303037N	30 cm		€ tbc	100	100	-

Picchetto speciale in ABS.



## STAKE SET

Art. 0303033N

€ tbc  
6 / 12 / -



Pratico set picchetti per camping e veicoli ricreazionali. Confezionato in contenitore di plastica.

### IL SET CONTIENE:

- 20 robusti picchetti in plastica da 23 cm per terreni erbosi e sabbiosi
- 10 picchetti per stuoia da 8 cm
- Attrezzo levapicchetti con manico rivestito





# PER TERRENI DURI

## SQUARE



		PACK	€ tbc	M.O.	Master	
Art. 0302010C	22 cm x Ø 8 mm	4X	€ tbc	20	60	-
Art. 0302010N	22 cm x Ø 8 mm		€ tbc	100	100	-
Art. 0302012C	30 cm x Ø 8 mm	4X	€ tbc	20	60	-
Art. 0302012N	30 cm x Ø 8 mm		€ tbc	100	100	-

Picchetto speciale quadrato per terreni duri. Acciaio zincato.

## STICK



		PACK	€ tbc	M.O.	Master	
Art. 0302017C	20 cm x Ø 6 mm	4X	€ tbc	20	20	-
Art. 0302017N	20 cm x Ø 6 mm		€ tbc	100	100	-
Art. 0302018C	25 cm x Ø 6 mm	4X	€ tbc	20	20	-
Art. 0302018N	25 cm x Ø 6 mm		€ tbc	100	100	-

Spillone chiodo, in acciaio zincato.

## SQUARE TWISTED



		PACK	€ tbc	M.O.	Master	
Art. 0302014C	22 cm	4X	€ tbc	20	60	-
Art. 0302014N	22 cm		€ tbc	100	100	-
Art. 0302015C	30 cm	4X	€ tbc	20	60	-
Art. 0302015N	30 cm		€ tbc	100	100	-



I picchetti Twisted sono realizzati in alluminio e garantiscono una maggiore tenuta nel terreno grazie alla loro ritorcitura.

## STICK PLUS



		PACK	€ tbc	M.O.	Master	
Art. 0303014C	23 cm x Ø 8 mm	4X	€ tbc	20	20	-
Art. 0303014N	23 cm x Ø 8 mm		€ tbc	50	50	-
Art. 0303015C	25 cm x Ø 8 mm	4X	€ tbc	20	60	-
Art. 0303015N	25 cm x Ø 8 mm		€ tbc	50	50	-



Spillone chiodo rotondo con gancio in plastica, in acciaio zincato.

## QUADRA



		PACK	€ tbc	M.O.	Master	
Art. 0302003C	18 cm x 5x5 mm	6X	€ tbc	20	60	-
Art. 0302003N	18 cm x 5x5 mm		€ tbc	100	100	-

Spillone quadrato, in acciaio zincato.

## HEXA



		PACK	€ tbc	M.O.	Master	
Art. 0303032C	22 cm x Ø 8 mm	4X	€ tbc	20	60	-
Art. 0303032N	22 cm x Ø 8 mm		€ tbc	100	100	-
Art. 0303034C	30 cm x Ø 8 mm	4X	€ tbc	20	60	-
Art. 0303034N	30 cm x Ø 8 mm		€ tbc	100	100	-

Picchetto speciale per terreni duri. Acciaio zincato.

## LINE



		PACK	€ tbc	M.O.	Master	
Art. 0302019C	18 cm x Ø 5 mm	6X	€ tbc	20	20	-
Art. 0302019N	18 cm x Ø 5 mm		€ tbc	100	100	-
Art. 0302020C	23 cm x Ø 5 mm	6X	€ tbc	20	20	-
Art. 0302020N	23 cm x Ø 5 mm		€ tbc	100	100	-
Art. 0302021C	28 cm x Ø 5 mm	6X	€ tbc	20	60	-
Art. 0302021N	28 cm x Ø 5 mm		€ tbc	100	100	-

Spillone rotondo, in acciaio zincato.

## MATRIX



		PACK	€ tbc	M.O.	Master	
Art. 0303038C	30 cm	2X	€ tbc	10	50	-
Art. 0303038N	30 cm		€ tbc	50	50	-
Art. 0303039C	40 cm	2X	€ tbc	10	50	-
Art. 0303039N	40 cm		€ tbc	50	50	-
Art. 0303040C	50 cm	2X	€ tbc	10	50	-
Art. 0303040N	50 cm		€ tbc	50	50	-

Picchetto a T in acciaio zincato, molto robusto.

# PER TERRENI MORBIDI E SABBIOSI





## TURCAL

		PACK		M.O.	Master	
Art. 0303005C	22 cm	6X	€ tbc	20	60	-
Art. 0303005N	22 cm		€ tbc	100	100	-
Art. 0303003C	26 cm	6X	€ tbc	20	60	-
Art. 0303003N	26 cm		€ tbc	100	100	-

 Spillone chiodo rotondo con gancio in plastica, in acciaio zincato.





## SANDLOCK

		PACK		M.O.	Master	
Art. 0303023C	31 cm	2X	€ tbc	10	50	-
Art. 0303023N	31 cm		€ tbc	50	200	-

Picchetto in alluminio per terreni sabbiosi o innevati.



## STABILIZER 38

		PACK		M.O.	Master	
Art. 0301313C	38 cm	2X	€ tbc	6	12	-
Art. 0301313N	38 cm		€ tbc	50	50	-

Picchetto in lamiera d'acciaio da 2 mm per terreni misti.

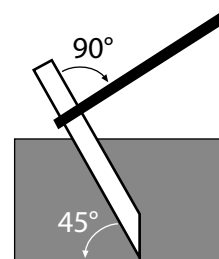

## RIO

Art. 0303043N

€ tbc  
12 / 48 / -

 39 cm x Ø 13/33 mm



Picchetto portaombrelloni realizzato in robusto materiale plastico. Con adattatore per steli da 13 a 33 mm.

## DRILLER

Art. 0303044N

€ tbc  
10 / 20 / -

 32,5 cm x Ø 13/33 mm



Picchetto portaombrelloni avvitabile per terreni sabbiosi. Con manico e vite di fissaggio per l'ombrellone. Realizzato in resistente materiale plastico.



## WAIKIKI BASIC

Art. 0303046N

€ tbc  
10 / 20 / -

 45 cm Ø tube 36 mm



Picchetto portaombrelloni in acciaio zincato.



## WINDBASE

Art. 0303056N

€ tbc  
6 / 12 / -

 35,5 x Ø 9,5 cm

PACK 1X

Supporto in acciaio zincato per pali paravento con diametro 25 mm. Rondella fissa.



## ELIX

Art. 0303066N

€ tbc  
10 / 50 / -

 42 cm x Ø 8 mm

Picchetto di ancoraggio in acciaio zincato, con anello di fissaggio.



# PER TERRENI DURI

# PEG BOX



## CLEAN SYSTEM



## PEG BOX STICK 20

Art. 0303067N

€ tbc  
10 / 10 / -

20 cm x Ø 6 mm

PACK 20X

26 x 8 x 17 cm

Spillone chiodo, in acciaio zincato.



## PEG BOX STICK 25

Art. 0303068N

€ tbc  
10 / 10 / -

25 cm x Ø 6 mm

PACK 20X

26 x 8 x 17 cm

Spillone chiodo, in acciaio zincato.



## PEG BOX STICK PLUS 23

Art. 0303069N

€ tbc  
10 / 10 / -

23 cm x Ø 8 mm

PACK 20X

26 x 8 x 17 cm

### GLOW



Spillone chiodo rotondo con gancio in plastica, in acciaio zincato.



## PEG BOX STICK PLUS 25

Art. 0303070N

€ tbc  
10 / 20 / -

25 cm x Ø 8 mm

PACK 20X

26 x 8 x 17 cm

### GLOW



Spillone chiodo rotondo con gancio in plastica, in acciaio zincato.



## PEG BOX SQUARE 22

Art. 0303071N

€ tbc  
10 / 20 / -

22 cm x Ø 8 mm

PACK 20X

26 x 8 x 17 cm

Picchetto speciale quadrato per terreni duri. Acciaio zincato.



## PEG BOX HEXA 22

Art. 0303072N

€ tbc  
10 / 20 / -

22 cm x Ø 8 mm

PACK 20X

26 x 8 x 17 cm

Picchetto speciale per terreni duri. Acciaio zincato.



## COBRA

			PACK	€ tbc	M.O.	Master	
Art. 0204001C	6 cm x Ø 4 mm	6X	€ tbc	20	80	-	
Art. 0204001N	6 cm x Ø 4 mm		€ tbc	100	100	-	

Gancio ad S in acciaio zincato.



## ANCHOR



			PACK	€ tbc	M.O.	Master	
Art. 0301048C	30 mm	10X	€ tbc	20	40	-	
Art. 0301048N	30 mm		€ tbc	100	100	-	

Gancio ad ancora in alluminio.



## SCREWBLOCK

			PACK	€ tbc	M.O.	Master	
Art. 0301059N	30 mm	4X	€ tbc	12	36	-	



Morsetto universale per funi e cavetti (non adatto per cavi elettrici).



## RUNNER XL

			PACK	€ tbc	M.O.	Master	
Art. 0301061C	Ø 4 mm	10X	€ tbc	10	100	-	
Art. 0301061N	Ø 4 mm		€ tbc	100	100	-	

Grande tenditore in alluminio a 3 fori adatto per corde di tensione fino a 4 mm di diametro. Colore: rosso anodizzato. Indicato in particolar modo per tende di grandi dimensioni e/o gazebi.

## RUNNER 2



			PACK	€ tbc	M.O.	Master	
Art. 0301063C	Ø 5 mm	10X	€ tbc	10	120	-	
Art. 0301063N	Ø 5 mm		€ tbc	100	100	-	

Tenditore per corda in alluminio a due fori.

## RUNNER 3



			PACK	€ tbc	M.O.	Master	
Art. 0301064C	Ø 4 mm	10X	€ tbc	10	120	-	
Art. 0301064N	Ø 4 mm		€ tbc	100	100	-	
Art. 0301067C	Ø 5 mm	10X	€ tbc	10	120	-	
Art. 0301067N	Ø 5 mm		€ tbc	100	100	-	

Tenditore per corda in alluminio a tre fori.



## CAPTURE

Art. 0102988N

€ tbc  
1 / 12 / -

Ø 5,4 cm  
120 g



Ventosa per tenda per minibus con corpo in metallo. Set 2 pz.



## VANOOK

Art. 0102973N

€ tbc  
12 / 24 / -

Ø 12 cm  
2x 250 g

### OPEN / CLOSE

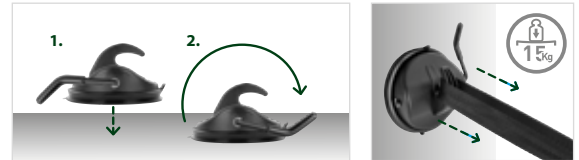

Set di ventose ad uncino per il fissaggio semplice, veloce e senza viti di tendalini, verande minibus e parasole. Basta posizionare la ventosa nella posizione desiderata sulla carrozzeria del veicolo ed azionare la levetta di bloccaggio. Ogni ventosa sopporta un carico di 15 kg. Set 2 pz.



## ATACO

Art. 0102985N

€ tbc  
6 / 6 / -

Ø 11,5 cm  
2x 238 g



Set di ventose con anello a D per il fissaggio senza viti di tendalini parasole, tende per minibus, teloni e molto altro ancora su superfici lisce. Possono essere caricate fino a max 12 kg. Set 2 pz.





## GORO

			M.O.	Master	
Art. 0301210N	Ø 3 mm x 20 m	€ tbc	12	12	-
Art. 0301212N	Ø 4 mm x 15 m	€ tbc	12	12	-

Cordino multiuso in poliestere intrecciato, su rocchetto.



## POWER

			M.O.	Master	
Art. 0301220N.C00	Ø 3 mm x 20 m	€ tbc	6	24	-
Art. 0301221N.C00	Ø 3 mm x 50 m	€ tbc	6	24	-
Art. 0301202N.C00	Ø 4 mm x 20 m	€ tbc	6	24	-
Art. 0301223N.C00	Ø 4 mm x 50 m	€ tbc	6	24	-
Art. 0301222N.C00	Ø 5 mm x 20 m	€ tbc	6	24	-
Art. 0301224N.C00	Ø 5 mm x 50 m	€ tbc	6	24	-

Corda multiuso, in PP intrecciato.



## SIGNAL

			M.O.	Master	
Art. 0301230N.C2M	Ø 3 mm x 20 m	€ tbc	6	24	-
Art. 0301231N.C2M	Ø 3 mm x 50 m	€ tbc	6	24	-

Corda multiuso con colorazione di sicurezza. In PP intrecciato.



## STRIPER

		PACK		M.O.	Master	
Art. 0301250N.C00	Ø 3 mm x 3 m	4X	€ tbc	20	20	-
Art. 0301251N.C00	Ø 3 mm x 4 m	4X	€ tbc	20	20	-
Art. 0301252N.C00	Ø 4 mm x 3 m	4X	€ tbc	20	20	-
Art. 0301253N.C00	Ø 4 mm x 4 m	4X	€ tbc	20	20	-

Corda tensione in PP con tenditore a tre fori.



## NOLAN

		PACK		M.O.	Master	
Art. 0301271N.C00	Ø 4 mm x 3 m	4X	€ tbc	6	60	-
Art. 0301272N.C00	Ø 4 mm x 4 m	4X	€ tbc	6	60	-
Art. 0301273N.C00	Ø 3 mm x 2 m	4X	€ tbc	6	60	-
Art. 0301274N.C00	Ø 3 mm x 3 m	4X	€ tbc	6	60	-
Art. 0301275N.C00	Ø 3 mm x 4 m	4X	€ tbc	6	60	-

Corda tensione in PP con tenditore a due fori ed anello.



## STABILIZER KIT

Art. 0301311N

€ tbc  
10 / 10 / -

1,2 kg

Cinghia stabilizzante per verande camper e caravan in caso di vento. Il kit comprende: 1 nastro stabilizzatore (13 m) con molla di tensione e grandi picchetti di ancoraggio.



## STABILIZER KIT UNIVERSAL

Art. 0301315N

€ tbc  
10 / 10 / -

1,2 kg

Kit cinghie stabilizzanti per verande caravan. Adatto per la maggior parte delle verande di produzione europea con fibbie pre-montate. Il set comprende 2 robusti picchetti di ancoraggio, 2 molle di scarico tensione e 2 cinghie di sicurezza.

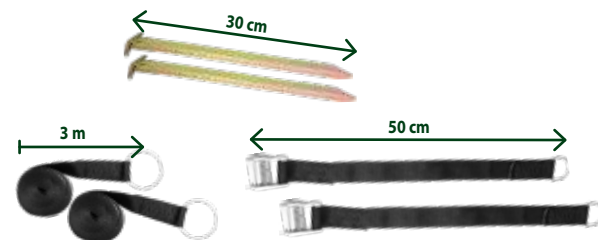

## PROP

Art. 0301312N

€ tbc  
10 / 20 / -

1,2 kg

Sistema stabilizzante per verande e tendalini parasole. Il set è dotato di 2 fibbie (2x 50cm+3m) e 2 picchetti robusti (2x 30cm). Pratica sacca custodia inclusa.





## EDOS

Art. 0301011C  
PACK 6X

€ tbc  
6 / 36 / -

Art. 0301011N  
PACK -

€ tbc  
100 / 100 / -

Ø 5 mm x 7,3 cm

Elastico per soprateli di tende a cupola.



## CIRCLE

Art. 0301022C  
PACK 6X

€ tbc  
10 / 40 / -

Art. 0301022N  
PACK -

€ tbc  
200 / 200 / -

Ø int. 6 cm

Anello tensione rotondo PVC soft.



## HOOKER

Art. 0301023C  
PACK 6X

€ tbc  
10 / 40 / -

Art. 0301023N  
PACK -

€ tbc  
50 / 50 / -

Ø 5 mm x 16 cm

Controllore di tensione con gancio per tende e verande.

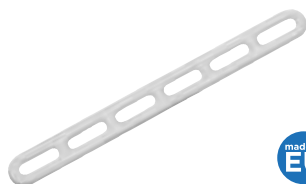

## SIX-PACK

Art. 0301029C  
PACK 6X

€ tbc  
10 / 50 / -

Art. 0301029N  
PACK -

€ tbc  
100 / 100 / -

21,5 x 2,5 cm

Elastico a scaletta a sei campi, senza linguetta.



# FLEXO



**FLEXO 8**



**FLEXO 12**



**FLEXO NT**

Anello in gomma per tende.  
Elevata resistenza alla rottura.

				PACK	€ tbc	M.O.	Master	
	<b>FLEXO 8</b>	Art. 0301019N	8 x 5 x 4 cm	10X	€ tbc	12	72	-
	<b>FLEXO 12</b>	Art. 0301020N	12 x 4 x 5 cm	10X	€ tbc	12	72	-
	<b>FLEXO NT</b>	Art. 0301021N	11 x 8 x 2 cm	10X	€ tbc	12	72	-





**STRETCH**

		PACK	M.O.	Master	
Art. 0902001C	Ø 0,8 x 50 cm	2X € tbc	10	40	-
Art. 0902001N	Ø 0,8 x 50 cm	€ tbc	20	20	-
Art. 0902003C	Ø 0,8 x 100 cm	2X € tbc	10	40	-
Art. 0902003N	Ø 0,8 x 100 cm	€ tbc	20	20	-
Art. 0902016C	Ø 0,8 x 150 cm	2X € tbc	10	20	-
Art. 0902016N	Ø 0,8 x 150 cm	€ tbc	10	10	-
Art. 0902017C	Ø 1 x 100 cm	2X € tbc	10	20	-
Art. 0902017N	Ø 1 x 100 cm	€ tbc	10	10	-
Art. 0902018C	Ø 1 x 150 cm	2X € tbc	10	20	-
Art. 0902018N	Ø 1 x 150 cm	€ tbc	10	10	-

Corda elastica fermabagagli con anima in gomma e ganci in acciaio su entrambi i lati.



**STRETCH SECURITY**

		PACK	M.O.	Master	
Art. 0902023C	Ø 0,8 x 100 cm	2X € tbc	10	40	-
Art. 0902023N	Ø 0,8 x 100 cm	€ tbc	40	40	-
Art. 0902024C	Ø 0,8 x 150 cm	2X € tbc	10	40	-
Art. 0902024N	Ø 0,8 x 150 cm	€ tbc	40	40	-

Corda elastica fermabagagli con anima in gomma e ganci in plastica su entrambi i lati.

**POWER FIX**

		PACK	M.O.	Master	
Art. 7710174C	50 x 2 cm	2X € tbc	12	24	-
Art. 7710177C	75 x 2 cm	2X € tbc	12	24	-
Art. 7710175C	100 x 2 cm	2X € tbc	12	24	-
Art. 7710178C	125 x 2 cm	2X € tbc	12	24	-
Art. 7710176C	150 x 2 cm	2X € tbc	12	24	-
Art. 7710179C	200 x 2 cm	2X € tbc	12	24	-
Art. 7710173C	250 x 2 cm	2X € tbc	12	24	-

Cinghiette di fissaggio con fibbia in metallo.

**POWER-STRAP**

		PACK	M.O.	Master	
Art. 7710180C	50 x 2 cm	2X € tbc	12	24	-
Art. 7710182C	75 x 2 cm	2X € tbc	12	24	-
Art. 7710184C	100 x 2 cm	2X € tbc	12	24	-

Cinghietta di fissaggio con fibbia di bloccaggio e regolazione in plastica.



**PACK SOLID 2,5**

Art. 7710183N

€ tbc  
6 / 24 / -

- 2,5 m x 25 mm
- 100% Polyester

**PACK SOLID 4**

Art. 7710185N

€ tbc  
6 / 24 / -

- 4,0 m x 25 mm
- 100% Polyester

Cinghia di fissaggio monopezzo con fibbia di bloccaggio in zinco pressofuso. Estremità della cinghia aperta per la reggiatura. Forza di ancoraggio: 5 daN (250 kg)

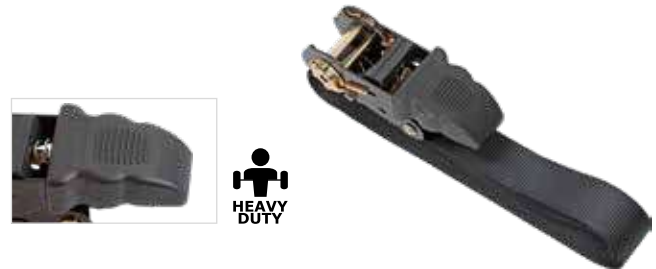

**PACK-MAN 2.0**

Art. 7710187N

€ tbc  
6 / 24 / -

- 5,0 m x 25 mm
- 100% Polyester

Cinghia di ancoraggio monopezzo con cricchetto robusto e antiscivolo in acciaio rivestito in gomma. Aree di applicazione: Kayak, barca, tenda, portapacchi, bicicletta, rimorchio, SUP, moto, tavola da surf, camper, caravan. Forza di ancoraggio: 8 daN (400kg)



## FORCE

Art. 0203040N

€ tbc  
6 / 24 / -

 32 cm x Ø 55 mm

 500 g

Martello da campeggio con manico in legno e mazzuolo in gomma.



## HIT

Art. 0203048N

€ tbc  
6 / 48 / -

 28,5 cm x Ø 52 mm

 390 g

Martello da campeggio con manico antiscivolo. Mazzuolo in gomma piena.



## BOMBER

Art. 0203008N

€ tbc  
10 / 50 / -

 31 x 11,3 x 4 cm

 360 g

Martello per camping multifunzione realizzato interamente in metallo con solida testa a 2 battenti martello/piccozza, pratico gancio per l'estrazione dei picchetti e cinturino di sicurezza per la mano.





## TRIFOLD

Art. 0203002N

€ tbc  
6 / 24 / -

 58 x 15,5 cm

 23,5 x 15,5 cm

 1,25 kg



Pala/zappa pieghevole in metallo forgiato. Lama seghettata e manico tubolare che viene serrato tramite un mandrino integrato. Completa di custodia.





# OUTDOOR EMOTIONS

## ARLO

Art. 0203012N

€ tbc  
6 / 12 / -

 95 x 21,5 x Ø 3/3,5 cm

 45 x 23 x 6 cm

 720 g



POLYCARBONATE

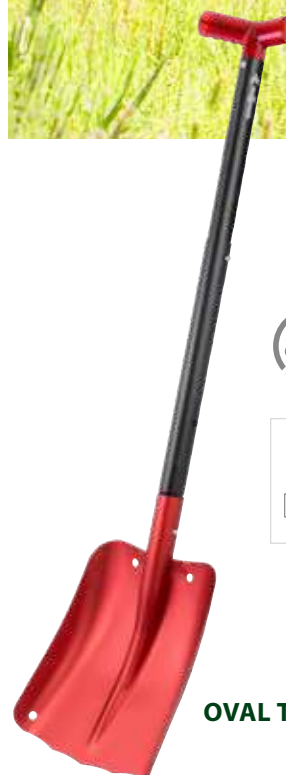

OVAL TUBE



Pala multiuso composta da 3 elementi realizzati in lega di alluminio con impugnatura asimmetrica in plastica. Costruzione resistente per l'outdoor, il campeggio, il survival e la caccia, ecc. Con pratico fodero per il trasporto.





### STRATOS

Art. 0202242C.C37

€ tbc  
5 / 20 / -



 25 m x 50 mm

PACK 1X



Nastro telato ad alta resistenza.



### POLE KIT

			M.O.	Master	
Art. 0103032N	Ø 7,9 mm - 4x 65 cm	€ tbc	6	12	-
Art. 0103033N	Ø 8,5 mm - 4x 65 cm	€ tbc	6	12	-
Art. 0103034N	Ø 9,5 mm - 4x 75 cm	€ tbc	6	12	-
Art. 0103035N	Ø 11 mm - 4x 75 cm	€ tbc	6	12	-
Art. 0103039N	Ø 12,7 mm - 4x 75 cm	€ tbc	6	12	-

### REPAIR KIT

			M.O.	Master	
Art. 0103037N	Ø 8,5/9,5 mm	€ tbc	5	25	-
Art. 0103040N	Ø 11/12,7 mm	€ tbc	5	25	-

Set pali di ricambio in fibra di vetro. Il set comprende: 4 pali in fibra di vetro con boccole premontate, un elastico di solidarizzazione e 2 puntali in metallo.

Set riparazione per tende composto da: pali di ricambio in fibra di vetro, elastico solidarizzatore, tessuto tenda e colla per tessuti.



## POLECAP



PACK

M.O. Master

Art. 0306015C	19 mm	4X	€ tbc	6	12	-
Art. 0306015N	19 mm		€ tbc	100	100	-
Art. 0306026C	22 mm	4X	€ tbc	6	12	-
Art. 0306026N	22 mm		€ tbc	100	100	-

Ventosa per palo tetto.



## POLESPIKE



PACK

M.O. Master

Art. 0306018C	19 mm	3X	€ tbc	6	12	-
Art. 0306018N	19 mm		€ tbc	50	50	-
Art. 0306019C	22 mm	3X	€ tbc	6	12	-
Art. 0306019N	22 mm		€ tbc	50	50	-
Art. 0306020C	25 mm	3X	€ tbc	6	12	-
Art. 0306020N	25 mm		€ tbc	50	50	-

Puntale in materiale plastico.



## POLEHOOK



PACK

M.O. Master

Art. 0306046C	Ø 22 mm	5X	€ tbc	6	12	-
Art. 0306046N	Ø 22 mm		€ tbc	100	100	-
Art. 0306047C	Ø 25 mm	5X	€ tbc	6	12	-
Art. 0306047N	Ø 25 mm		€ tbc	100	100	-

Gancio per palo.



## POLESTING



PACK

M.O. Master

Art. 0306048C	Ø 22 mm	5X	€ tbc	6	12	-
Art. 0306048N	Ø 22 mm		€ tbc	100	100	-
Art. 0306049C	Ø 25 mm	5X	€ tbc	6	12	-
Art. 0306049N	Ø 25 mm		€ tbc	100	100	-

Puntale per palo.

## POLECLAMP



PACK

M.O. Master

Art. 0306051C	Ø 22 - 25 mm	4X	€ tbc	6	12	-
Art. 0306051N	Ø 22 - 25 mm		€ tbc	100	100	-
Art. 0306052C	Ø 25 - 28 mm	4X	€ tbc	6	12	-
Art. 0306052N	Ø 25 - 28 mm		€ tbc	100	100	-

Morsetto per palo.



## SMARTLOCK



PACK

M.O. Master

Art. 0305060C	22/19 mm	3X	€ tbc	6	24	-
Art. 0305061C	25/22 mm	3X	€ tbc	6	24	-
Art. 0305063C	28/25 mm	3X	€ tbc	6	24	-
Art. 0305067C	32/28 mm	3X	€ tbc	6	24	-

**Blocca-pali in plastica Smartlock. Disponibili per tutti i diametri di paleria più comuni.**

### ULTERIORI VANTAGGI DEGLI SMARTLOCK:

- Semplice da sostituire
- Sistema di bloccaggio senza viti e privo di parti metalliche
- Nessun danno o deformazione alla paleria
- Adatti a pali in acciaio e alluminio
- Di semplice utilizzo



## SUPPORTER



PACK

M.O. Master

Art. 0306022C	Ø 22 mm	3X	€ tbc	6	12	-
Art. 0306022N	Ø 22 mm		€ tbc	100	100	-

Supporto paleria orizzontale in materiale plastico.



## MINIBASE

Art. 0306029N

€ tbc  
10 / 40 / -

Ø 80 x H30 mm

PACK 2X

Base di appoggio per pali verticali, gradini d'entrata, ecc. Prodotto in materiale plastico robusto e stabile.

## ROTOBASE

Art. 0306032N

€ tbc  
10 / 40 / -

Ø 80 x 45 mm

PACK 2X

Base di appoggio con snodo rotante per pali verticali, gradini d'entrata, ecc. Prodotto in materiale plastico robusto e stabile.





## BLOCKER SHS

		PACK	€ tbc	M.O.	Master	
Art. 0306008C	Ø 5 cm	3X	€ tbc	12	48	-
Art. 0306008N	Ø 5 cm		€ tbc	10	100	-

Sistema di aggancio senza viti SHS.



## STOPPER SHS

		PACK	€ tbc	M.O.	Master	
Art. 0306009C	5 x 7 cm	3X	€ tbc	3	12	-
Art. 0306009N	5 x 7 cm		€ tbc	10	100	-

Stopper SHS per tutte le verande SHS moderne con doppio profilo di scorrimento.



## DOUBLE 8

			€ tbc	M.O.	Master	
Art. 7401021N	100 cm		€ tbc	12	12	-
Art. 7401022N	250 cm		€ tbc	6	6	-

Sistema di aggancio senza viti SHS.

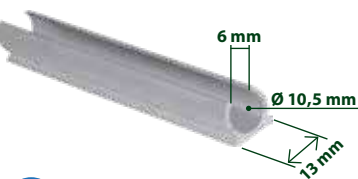

## ALU RAIL

Art. 7401023N	€ tbc
	1 / 1 / -

3 m

Profilo in alluminio anodizzato.

# QEDER

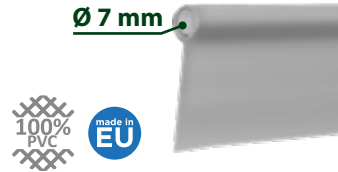

## QEDER PVC

Art. 7401197N	€ tbc
	1 / 2 / -

Ø 7 mm, roll 50m x H25 mm

Profilo di scorrimento con flangia larga 25 mm.



## QEDER SHS

Art. 7401195N	€ tbc
	50 / 100 / -

Ø 4/7 mm, roll 50m x H25 mm

Esecuzione come Art. 7401192N ma adatta al sistema di fissaggio senza viti (SHS). Profilo di scorrimento con flangia larga 25 mm.



## QEDER

			€ tbc	M.O.	Master	
Art. 7401196N	Ø 5 mm, roll 50m x H25 mm		€ tbc	50	100	-
Art. 7401192N	Ø 7 mm, roll 50m x H25 mm		€ tbc	50	100	-

Profilo di scorrimento con flangia larga 25 mm.

## QEDER ADAPTER SET

			€ tbc	M.O.	Master	
Art. 7401019N	Ø 5 mm x 3 m		€ tbc	1	10	-
Art. 7401020N	Ø 7 mm x 3 m		€ tbc	1	10	-

Kit per collegare la tenda minibus al veicolo.

# TELEPOLE

## TELEPOLE 80-190

Art. 0305034N	€ tbc
	6 / 24 / -

80 - 190 cm

Palo verticale telescopico in alluminio anodizzato a tre elementi Ø 31/26/21 mm. Con puntale e base.

## TELEPOLE 100-230

Art. 0305035N	€ tbc
	6 / 24 / -

100 - 230 cm

Art. 0305036N	€ tbc
	2 / 6 / -

100 - 230 cm

PACK 2X





# SMARTPOLE

Pali aggiuntivi per dare alla veranda ulteriore stabilità in caso di vento forte, pioggia o neve. I nostri pali sono disponibili in 2 versioni.

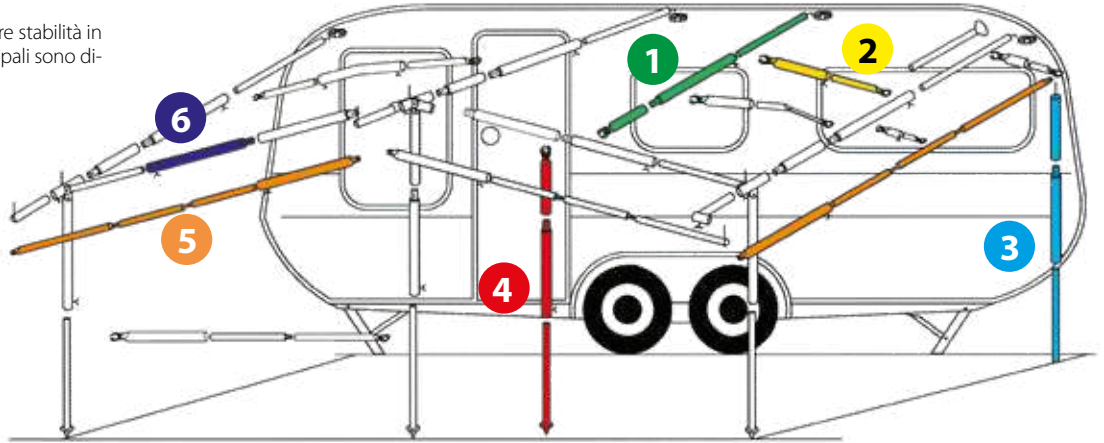

Acciaio: viene utilizzato nelle verande permanenti o invernali a causa della particolare rigidità. Tutti i pali Brunner in acciaio sono stati sottoposti ad un doppio processo di protezione (zincatura e laccatura).



Alluminio: materiale ideale per tende leggere da viaggio e tendalini. Caratteristiche: peso ridotto, praticamente non corrodibile. Tutti i pali Brunner in alluminio dispongono di una superficie anodizzata.

## 1 SMARTPOLE RIDGE



Acciaio



		PACK		M.O.	Master	
Art. 0305021C	Ø 22x1/115-200 cm	1X	€ tbc	5	10	-
Art. 0305021N	Ø 22x1/115-200 cm		€ tbc	10	10	-
Art. 0305048C	Ø 22x1/170-260 cm	1X	€ tbc	5	10	-
Art. 0305048N	Ø 22x1/170-260 cm		€ tbc	10	10	-
Art. 0305025C	Ø 25x1/170-260 cm	1X	€ tbc	5	10	-
Art. 0305025N	Ø 25x1/170-260 cm		€ tbc	10	10	-



		PACK		M.O.	Master	
Art. 0305050C	Ø 25x1/170-260 cm	1X	€ tbc	5	10	-
Art. 0305050N	Ø 25x1/170-260 cm		€ tbc	10	10	-

## 2 SMARTPOLE ROOF SUPPORT



Acciaio



		PACK		M.O.	Master	
Art. 0305006C	Ø 22x1/75-120 cm	1X	€ tbc	5	10	-
Art. 0305006N	Ø 22x1/75-120 cm		€ tbc	10	10	-
Art. 0305041C	Ø 22x1/115-200 cm	1X	€ tbc	5	10	-
Art. 0305041N	Ø 22x1/115-200 cm		€ tbc	10	10	-
Art. 0305049C	Ø 25x1/115-200 cm	1X	€ tbc	5	10	-
Art. 0305049N	Ø 25x1/115-200 cm		€ tbc	10	10	-
Art. 0305046C	Ø 22x1/170-260 cm	1X	€ tbc	5	10	-
Art. 0305046N	Ø 22x1/170-260 cm		€ tbc	10	10	-
Art. 0305057C	Ø 25x1/170-260 cm	1X	€ tbc	5	10	-
Art. 0305057N	Ø 25x1/170-260 cm		€ tbc	10	10	-



		PACK		M.O.	Master	
Art. 0305070C	Ø 25x1/115-205 cm	1X	€ tbc	5	10	-
Art. 0305070N	Ø 25x1/115-205 cm		€ tbc	10	10	-
Art. 0305071C	Ø 25x1/170-260 cm	1X	€ tbc	5	10	-
Art. 0305071N	Ø 25x1/170-260 cm		€ tbc	10	10	-





### 3 SMARTPOLE UP-RIGHT



Acciaio

			PACK	€ tbc	M.O.	Master	
Art. 0305022C	Ø 22x1/110-200 cm	1X	€ tbc	5	10	-	
Art. 0305022N	Ø 22x1/110-200 cm		€ tbc	10	10	-	
Art. 0305028C	Ø 22x1/165-250 cm	1X	€ tbc	5	10	-	
Art. 0305028N	Ø 22x1/165-250 cm		€ tbc	10	10	-	



			PACK	€ tbc	M.O.	Master	
Art. 0305037C	Ø 25x1/110-200 cm	1X	€ tbc	5	10	-	
Art. 0305037N	Ø 25x1/110-200 cm		€ tbc	10	10	-	
Art. 0305038C	Ø 25x1/165-250 cm	1X	€ tbc	5	10	-	
Art. 0305038N	Ø 25x1/165-250 cm		€ tbc	10	10	-	

### 4 SMARTPOLE STORM



Acciaio

			PACK	€ tbc	M.O.	Master	
Art. 0305103C	Ø 22x1/115-200 cm	1X	€ tbc	5	10	-	
Art. 0305103N	Ø 22x1/115-200 cm		€ tbc	10	10	-	
Art. 0305047C	Ø 22x1/170-260 cm	1X	€ tbc	5	10	-	
Art. 0305047N	Ø 22x1/170-260 cm		€ tbc	10	10	-	
Art. 0305098C	Ø 25x1/170-260 cm	1X	€ tbc	5	10	-	
Art. 0305098N	Ø 25x1/170-260 cm		€ tbc	10	10	-	



			PACK	€ tbc	M.O.	Master	
Art. 0305145C	Ø 25x1/115-200 cm	1X	€ tbc	5	10	-	
Art. 0305145N	Ø 25x1/115-200 cm		€ tbc	10	10	-	
Art. 0305146C	Ø 25x1/170-260 cm	1X	€ tbc	5	10	-	
Art. 0305146N	Ø 25x1/170-260 cm		€ tbc	10	10	-	

### 5 SMARTPOLE TENSION FLAT ENDS



Acciaio

			PACK	€ tbc	M.O.	Master	
Art. 0305024C	Ø 22x1/110-200 cm	1X	€ tbc	5	5	-	
Art. 0305024N	Ø 22x1/110-200 cm		€ tbc	10	10	-	
Art. 0305023C	Ø 22x1/200-280 cm	1X	€ tbc	5	10	-	
Art. 0305023N	Ø 22x1/200-280 cm		€ tbc	10	10	-	



			PACK	€ tbc	M.O.	Master	
Art. 0305032C	Ø 25x1/110-200 cm	1X	€ tbc	5	10	-	
Art. 0305032N	Ø 25x1/110-200 cm		€ tbc	10	10	-	
Art. 0305033C	Ø 25x1/200-280 cm	1X	€ tbc	5	10	-	
Art. 0305033N	Ø 25x1/200-280 cm		€ tbc	10	10	-	

### 6 SMARTPOLE EXTENSION



Acciaio

			PACK	€ tbc	M.O.	Master	
Art. 0305003C	Ø 19x1/80 cm	1X	€ tbc	5	10	-	
Art. 0305003N	Ø 19x1/80 cm		€ tbc	10	10	-	
Art. 0305001C	Ø 22x1/80 cm	1X	€ tbc	5	10	-	
Art. 0305001N	Ø 22x1/80 cm		€ tbc	10	10	-	
Art. 0305002C	Ø 25x1/80 cm	1X	€ tbc	5	10	-	
Art. 0305002N	Ø 25x1/80 cm		€ tbc	10	10	-	



			PACK	€ tbc	M.O.	Master	
Art. 0305044C	Ø 25x1/80 cm	1X	€ tbc	5	10	-	
Art. 0305044N	Ø 25x1/80 cm		€ tbc	10	10	-	



## MULTICOVER



COLOR



			M.O.	Master	
Art. 7130270N.C74	200 x 200 cm	€ tbc	25	25	-
Art. 7130271N.C74	200 x 300 cm	€ tbc	20	20	-
Art. 7130277N.C74	300 x 300 cm	€ tbc	10	10	-
Art. 7130272N.C74	300 x 400 cm	€ tbc	10	10	-
Art. 7130285N.C74	300 x 500 cm	€ tbc	6	6	-
Art. 7130286N.C74	300 x 600 cm	€ tbc	4	4	80
Art. 7130287N.C74	300 x 700 cm	€ tbc	5	5	90
Art. 7130278N.C74	400 x 400 cm	€ tbc	10	10	-
Art. 7130273N.C74	400 x 500 cm	€ tbc	6	6	-
Art. 7130279N.C74	400 x 600 cm	€ tbc	5	5	80
Art. 7130288N.C74	400 x 700 cm	€ tbc	5	5	30
Art. 7130280N.C74	500 x 500 cm	€ tbc	5	5	-
Art. 7130274N.C74	500 x 600 cm	€ tbc	4	4	48
Art. 7130275N.C74	500 x 700 cm	€ tbc	3	3	-
Art. 7130281N.C74	600 x 700 cm	€ tbc	3	3	48
Art. 7130276N.C74	600 x 800 cm	€ tbc	2	2	42
Art. 7130282N.C74	600 x 1000 cm	€ tbc	2	2	32
Art. 7130283N.C74	800 x 1000 cm	€ tbc	2	2	24



Teloni di copertura in PE laminato su entrambi i lati.



## GROMMET

Art. 0202044N

€ tbc  
12 / 144 / -

Ø int. 11 mm

PACK 8X

Set di occhielli in plastica per teloni.



## EYELET

Art. 0202045N

€ tbc  
12 / 72 / -

Ø int. 10 mm

PACK 20X

Occhielli in ottone completi di kit di montaggio.



## CONNEX

Art. 0202053N

€ tbc  
10 / 200 / -

Ø 2,5 cm

PACK 10X

Set di bottoni in materiale plastico.



## SNAP

Art. 0202054N

€ tbc  
12 / 144 / -

Ø int. 10 mm

PACK 8X

Bottoni a pressione in metallo nichelato completi di kit per l'applicazione.



# MULTICOVER



## MULTICOVER 100



COLOR C06

			M.O.	Master	
Art. 7130290N.C06	200 x 200 cm	€ tbc	25	25	-
Art. 7130291N.C06	200 x 300 cm	€ tbc	20	20	-
Art. 7130292N.C06	300 x 300 cm	€ tbc	10	10	-
Art. 7130293N.C06	300 x 400 cm	€ tbc	10	10	-
Art. 7130294N.C06	400 x 400 cm	€ tbc	10	10	-
Art. 7130295N.C06	400 x 500 cm	€ tbc	6	6	-
Art. 7130296N.C06	400 x 600 cm	€ tbc	5	5	-



Teloni di copertura in polietilene, spalmati su entrambi i lati. Dotati di occhielli su tutti gli angoli e lungo i bordi rinforzati per un fissaggio semplice. Ideale per coprire e proteggere dalle intemperie mobili da giardino e camping, rimorchi, biciclette, catini di tende e verande ed equipaggiamento vario tra cui anche materiale edile.



### TARPCLIP

Art. 0301051N

€ tbc  
6 / 84 / -

 4 x 8 cm

PACK 4X

Morsetto rapido per stuoie veranda, tappeti e teloni. Prodotto in nylon rinforzato con fibra di vetro di lunga durata.



### TARPEYE

Art. 0301054N

€ tbc  
50 / 200 / -

 5 x 10 cm

PACK 4X

Occhiello in plastica per teloni.



### BUNGEE BALL

Art. 0301057C  
PACK 6X

€ tbc  
5 / 20 / -

Art. 0301057N  
PACK -

€ tbc  
50 / 500 / -

 Ø int. 10 mm

PACK 6X

Sfera bloccateli con elastico per occhielli di diametro massimo 25 mm.



### CLAMP

Art. 0301060C  
PACK 4X

€ tbc  
12 / 72 / -

Art. 0301060N  
PACK -

€ tbc  
100 / 500 / -

 25 mm x Ø 4 mm

PACK 4X

Aggancio per stuoie e teloni. In plastica flessibile.





# FLOOR & DOOR

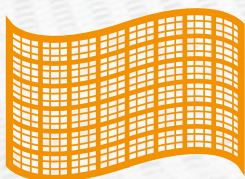

**STUOIE E PEDANE  
TENDE PER PORTE**





	PARAGON	PURAMAT	BALMAT	TRIP	BRIOLITE	YUROP	KINETIC	KINETIC	KINETIC
TESSUTO	PE	PES	PP	PP	PP	PVC/PES	PVC/PET	PVC/PET	PVC/PET
PESO TESSUTO	250 g/m <sup>2</sup>	350 g/m <sup>2</sup>	350 g/m <sup>2</sup>	200 g/m <sup>2</sup>	300 g/m <sup>2</sup>	450 g/m <sup>2</sup>	400 g/m <sup>2</sup>	500 g/m <sup>2</sup>	600 g/m <sup>2</sup>
SENZA FTALATI	■	-	■	■	■	■	■	■	■
TAGLIABILE A FREDDO	-	-	-	-	-	■	■	■	■
TRASPIRANTE	■	■	■	■	■	■	-	-	-
IN ROTOLI	-	-	-	■	■	■	■	■	■
IN TAGLI	■	■	■	■	■	■	■	■	■





# PARAGON



PARAGON



PHTHALATE free



BAG



M.O.

Master



Art. 0201284N	250 x 300 cm	€ tbc	2	2	48
Art. 0201286N	250 x 400 cm	€ tbc	2	2	48
Art. 0201288N	250 x 500 cm	€ tbc	2	2	40
Art. 0201290N	250 x 600 cm	€ tbc	2	2	36

C52



La stuoia Paragon è la soluzione ideale per le verande ed i tendalini di roulotte e camper, absidi tende, cucinotti e gazebo. Completa di lati bordati ed occhielli.

#### CARATTERISTICHE:

- Traspirante
- Realizzata in tessuto eco-compatibile
- Protegge efficacemente contro gli insetti fastidiosi
- Facile da pulire
- Materiale durevole
- Dotata di pratici occhielli
- Resistente ai raggi UV
- Imputrescibile
- Resistente alle intemperie
- Con borsa per il trasporto



# PURAMAT



Stuoia per tende e tendalini, antipolvere ed anti-sabbia e realizzata con un nuovo materiale in poliestere appositamente lavorato.

## CARATTERISTICHE:

- Permeabile all'aria
- Idrorepellente
- Leggera
- Facile da piegare
- Non si sfilaccia
- Durevole
- Con anelli di fissaggio agli angoli
- Incl. borsa custodia



## PURAMAT

			M.O.	Master	
Art. 0201251N	250 x 300 cm	€ tbc	2	2	-
Art. 0201252N	250 x 350 cm	€ tbc	2	2	-
Art. 0201253N	250 x 400 cm	€ tbc	2	2	-
Art. 0201254N	250 x 450 cm	€ tbc	2	2	-
Art. 0201255N	250 x 500 cm	€ tbc	2	2	-







## BALMAT



BAG

			M.O.	Master	
Art. 0102044N	250 x 300 cm	€ tbc	2	2	20
Art. 0102045N	250 x 350 cm	€ tbc	2	2	24
Art. 0102046N	250 x 400 cm	€ tbc	2	2	20
Art. 0102047N	250 x 450 cm	€ tbc	2	2	20
Art. 0102064N	250 x 500 cm	€ tbc	2	2	20
Art. 0102065N	250 x 600 cm	€ tbc	2	2	20
Art. 0102066N	250 x 700 cm	€ tbc	2	2	12

# BALMAT

**PHTHALATE free**

100%  
PP



350g/m<sup>2</sup>

Stuoia per verande leggerissima. Utilizzabile su entrambi i lati. Particolarmente indicata per caravan e camper di dimensioni piccole/medie.

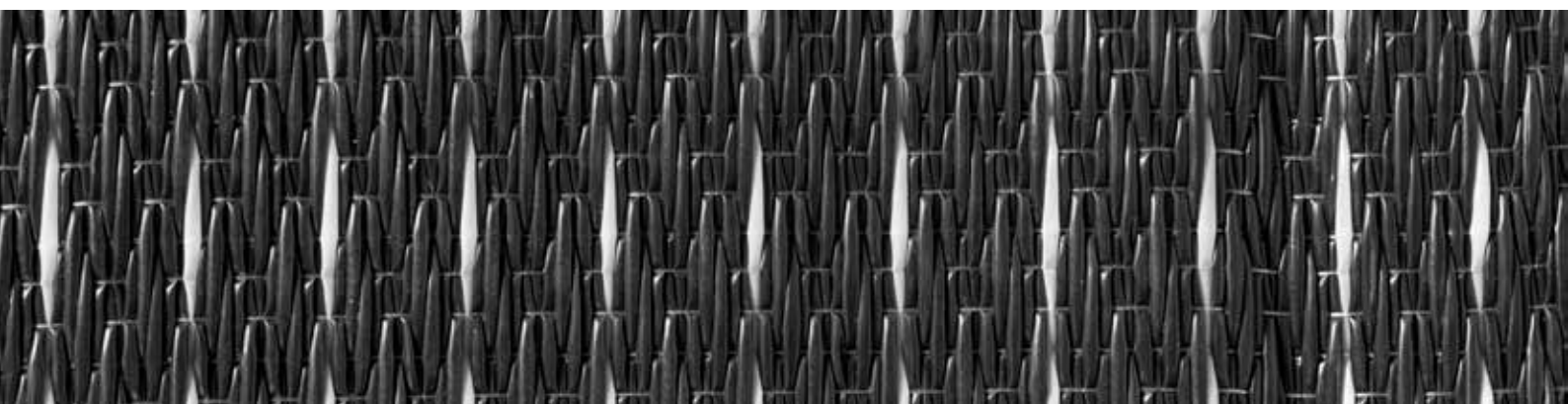





## BALMAT



BAG

				M.O.	Master	
Art. 0102044N	250 x 300 cm	€ tbc	2	2	24	
Art. 0102045N	250 x 350 cm	€ tbc	2	2	20	
Art. 0102046N	250 x 400 cm	€ tbc	2	2	20	
Art. 0102047N	250 x 450 cm	€ tbc	2	2	20	
Art. 0102064N	250 x 500 cm	€ tbc	2	2	20	
Art. 0102065N	250 x 600 cm	€ tbc	2	2	20	
Art. 0102066N	250 x 700 cm	€ tbc	2	2	12	
Art. 0102067N	300 x 300 cm	€ tbc	2	2	16	
Art. 0102068N	300 x 350 cm	€ tbc	2	2	16	
Art. 0102069N	300 x 400 cm	€ tbc	2	2	16	
Art. 0102070N	300 x 450 cm	€ tbc	2	2	16	
Art. 0102071N	300 x 500 cm	€ tbc	2	2	16	
Art. 0102072N	300 x 600 cm	€ tbc	2	2	16	
Art. 0102073N	300 x 700 cm	€ tbc	2	2	12	

## BALMAT

PHTHALATE free



Stuoia per verande leggerissima. Utilizzabile su entrambi i lati. Particolarmente indicata per caravan e camper di dimensioni piccole/medie.

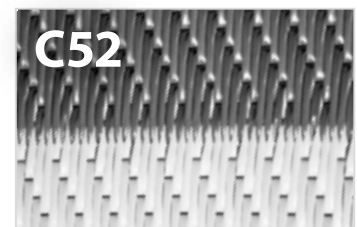

## INFO



**Stuoia leggera e salvaspazio in fibra di polipropilene a lunga durata. Ideale per il campeggio itinerante, ma anche per le verande delle caravan. La struttura in tessuto traspirante e indeformabile permette al terreno di respirare e crea un piacevole ambiente di soggiorno. Disponibile in varie dimensioni, colori e spessori di materiale.**

## IN EVIDENZA:

- Facile da pulire
- Lavabile
- Imputrescibile
- Traspirante
- Antistrappo
- Resistente ai raggi UV
- Riciclabile
- Con borsa di trasporto riutilizzabile



# TRIP



## TRIP

PHTHALATE free

		ROLL		BAG			
		M.O.		Master			
Art. 0201241N	H2,5 x 50 m (€/m)	€ tbc	50	50	-		



		BAG			
		M.O.		Master	
Art. 0201242N	250 x 300 cm	€ tbc	1	10	80
Art. 0201243N	250 x 350 cm	€ tbc	1	9	72
Art. 0201244N	250 x 400 cm	€ tbc	1	8	64
Art. 0201245N	250 x 450 cm	€ tbc	1	8	64
Art. 0201246N	250 x 500 cm	€ tbc	1	7	56
Art. 0201247N	250 x 600 cm	€ tbc	1	6	48
Art. 0201248N	250 x 700 cm	€ tbc	1	5	21

Resistente stuoia per tende e verande.

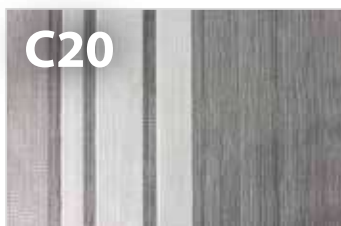

### C20



**LAVABILE:  
ASCIUGA RAPIDAMENTE**



**LUNGA DURATA  
RESISTENTE ALL'USURA**



# BRIOLITE



## BRIOLITE

PHTHALATE free

		ROLL		BAG			
		M.O.		Master			
Art. 0201076N	H 2,5 x 50 m (€/m)	€ tbc	50	50	-		



		BAG			
		M.O.		Master	
Art. 0201091N	250 x 300 cm	€ tbc	1	10	80
Art. 0201092N	250 x 350 cm	€ tbc	1	9	72
Art. 0201093N	250 x 400 cm	€ tbc	1	8	72
Art. 0201094N	250 x 450 cm	€ tbc	1	8	64
Art. 0201095N	250 x 500 cm	€ tbc	1	7	56
Art. 0201096N	250 x 600 cm	€ tbc	1	6	48
Art. 0201097N	250 x 700 cm	€ tbc	1	5	40

Stuoia per tende e verande in tessuto PP.

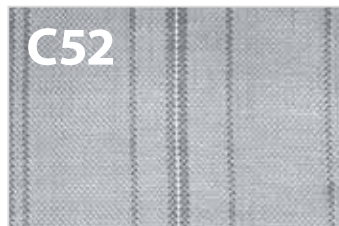

### C52



### C57



**RESISTENTE ALL'UMIDITA'**



**RESISTENTE AI  
RAGGI UV**



## YUROP

## YUROP



Art.	M.O.	Master	COLOR		
			C06	C30	C9D
Art. 0201074N	H2,5 x 30 m (€/m)	€ tbc	1	1	-
Art. 0201075N	H3 x 30 m (€/m)	€ tbc	1	1	-



Art.	M.O.	Master	COLOR		
			C30	C9D	
Art. 0201077N	250 x 300 cm	€ tbc	2	2	32
Art. 0201081N	250 x 350 cm	€ tbc	2	2	32
Art. 0201082N	250 x 400 cm	€ tbc	2	2	36
Art. 0201083N	250 x 450 cm	€ tbc	2	2	32
Art. 0201088N	250 x 500 cm	€ tbc	2	2	32
Art. 0201089N	250 x 600 cm	€ tbc	2	2	32
Art. 0201078N	300 x 300 cm	€ tbc	2	2	24
Art. 0201079N	300 x 400 cm	€ tbc	2	2	32
Art. 0201080N	300 x 500 cm	€ tbc	2	2	32
Art. 0201084N	300 x 600 cm	€ tbc	1	1	16
Art. 0201085N	300 x 700 cm	€ tbc	1	1	14

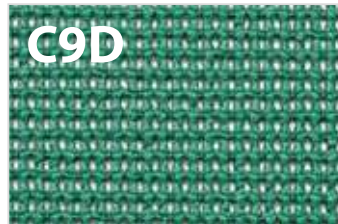
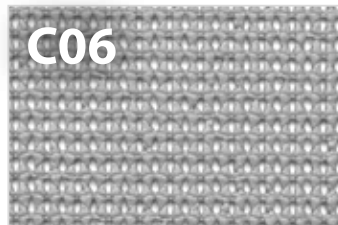

Stuoia per tende e verande in filo di poliestere schiumato.



**PTHALATE free**

La stuoia Yurop è un classico quando si è in tema di accessori per il campeggio. La sua robustezza, la sua elasticità ed il suo comfort al tatto la rendono una soluzione estremamente pratica da usare per rendere il pavimento delle tende o delle tende da sole elegante e accogliente. Disponibile in diverse taglie.

#### HIGHLIGHTS:

- Facile da pulire
- Tagliabile
- Imputrescibile
- Piacevole comfort al tatto
- Traspirante
- Antistrappo
- Resistente ai raggi UV
- Antiscivolo
- Con borsa di trasporto riutilizzabile

### CARPEG

Art. 0303013C  
PACK 6X € tbc  
6 / 30 / -

Art. 0303013N  
PACK - € tbc  
100 / 100 / -

20 cm x Ø 6 mm

Spillone chiodo fermastuoia in acciaio con ranella Ø 38 mm in materiale plastico.

### PEGGY

Art. 0303019C  
PACK 6X € tbc  
10 / 50 / -

Art. 0303019N  
PACK - € tbc  
100 / 100 / -

20 cm x Ø 8 mm

Speciale picchetto in metallo per fissare stuoie e teloni.

### PICKET

Art. 0303018C  
PACK 6X € tbc  
10 / 50 / -

12 cm x Ø 2 cm

Picchetto fermastuoia in materiale plastico.



# KINETIC



Stuoia per verande di ottima qualità perfettamente indicata sia per campeggio stanziale che quello itinerante ed abbinabile a verande caravan, verande avvolgibili, tendalini parasole e tende per minivan. Realizzata in ottima fibra sintetica resistente ai raggi UV. Utilizzabile su entrambi i lati. Idrorepellente, imputrescibile e facile da pulire. Accorciabile a freddo senza pericolo che si sfrangi. Senza ftalati. Disponibile in ben 12 misure pretagliate ed in 3 grammature di tessuto, selezionabili a seconda dell'utilizzo previsto.

**PHTHALATE free**



30% PET  
70% PVC

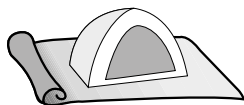
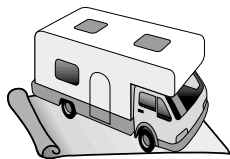
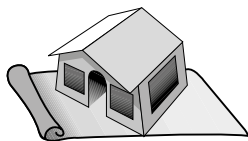
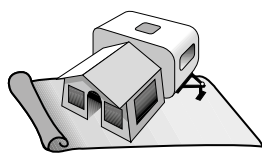

**Stuoia per verande di ottima qualità perfettamente indicata sia per il campeggio stanziale che per quello itinerante. Disponibile in 3 grammature di tessuto, selezionabili a seconda dell'utilizzo previsto.**

### CARATTERISTICHE:

- Tessitura speciale ad alta resistenza
- Utilizzabile su entrambi i lati
- Accorciabile a freddo
- Imputrescibile
- Idrorepellente
- Lavabile
- Senza ftalati

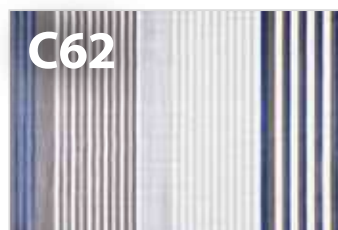

C62

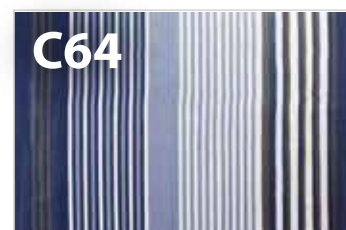

C64

## KINETIC 400



Art.	Misure (€/m)	€ tbc	M.O.	Master	Icon
Art. 0201136N	H2,5 x 30 m (€/m)	€ tbc	1	1	-



Art.	Misure	€ tbc	M.O.	Master	Icon
Art. 0201137N	250 x 300 cm	€ tbc	2	2	56
Art. 0201138N	250 x 350 cm	€ tbc	2	2	56
Art. 0201139N	250 x 400 cm	€ tbc	2	2	56
Art. 0201146N	250 x 450 cm	€ tbc	2	2	56
Art. 0201147N	250 x 500 cm	€ tbc	2	2	56
Art. 0201148N	250 x 600 cm	€ tbc	2	2	56
Art. 0201149N	250 x 700 cm	€ tbc	2	2	56



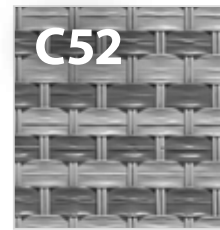
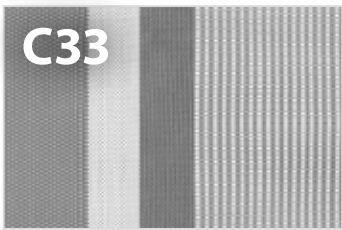
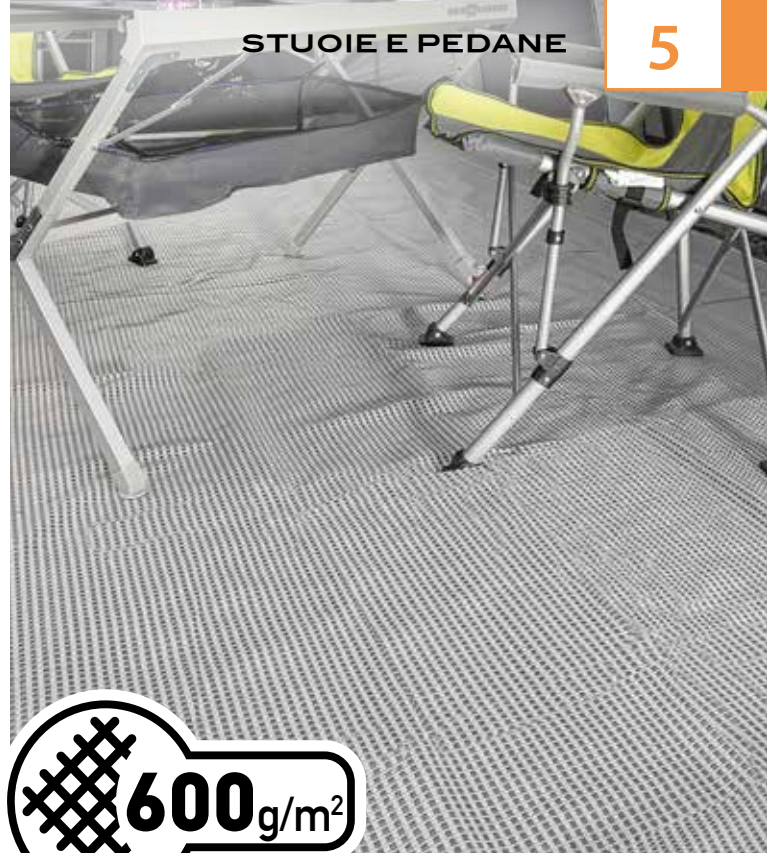

**KINETIC 500**



Art.	Size (€)	Price	M.O.	Master	Icon
Art. 0201260N	H2,5 x 30 m (€/m)	€ tbc	1	1	-
Art. 0201261N	H3 x 30 m (€/m)	€ tbc	1	1	-



Art.	Size	Price	M.O.	Master	Icon
Art. 0201262N	250 x 300 cm	€ tbc	2	2	48
Art. 0201263N	250 x 350 cm	€ tbc	2	2	48
Art. 0201264N	250 x 400 cm	€ tbc	2	2	40
Art. 0201265N	250 x 450 cm	€ tbc	2	2	40
Art. 0201266N	250 x 500 cm	€ tbc	2	2	40
Art. 0201267N	250 x 600 cm	€ tbc	2	2	32
Art. 0201268N	250 x 700 cm	€ tbc	2	2	32
Art. 0201269N	300 x 300 cm	€ tbc	2	2	48
Art. 0201270N	300 x 400 cm	€ tbc	2	2	48
Art. 0201271N	300 x 500 cm	€ tbc	2	2	48
Art. 0201272N	300 x 600 cm	€ tbc	2	2	32
Art. 0201273N	300 x 700 cm	€ tbc	2	2	26

**KINETIC 600**



Art.	Size (€)	Price	M.O.	Master	Icon
Art. 0201105N	H2,5 x 30 m (€/m)	€ tbc	30	30	-
Art. 0201118N	H3 x 30 m (€/m)	€ tbc	30	30	-



Art.	Size	Price	M.O.	Master	Icon
Art. 0201106N	250 x 300 cm	€ tbc	2	2	56
Art. 0201107N	250 x 350 cm	€ tbc	2	2	56
Art. 0201108N	250 x 400 cm	€ tbc	2	2	56
Art. 0201109N	250 x 450 cm	€ tbc	2	2	48
Art. 0201110N	250 x 500 cm	€ tbc	2	2	48
Art. 0201111N	250 x 600 cm	€ tbc	2	2	40
Art. 0201112N	250 x 700 cm	€ tbc	2	2	32
Art. 0201131N	300 x 300 cm	€ tbc	2	2	48
Art. 0201132N	300 x 400 cm	€ tbc	2	2	48
Art. 0201133N	300 x 500 cm	€ tbc	2	2	40
Art. 0201134N	300 x 600 cm	€ tbc	2	2	32
Art. 0201135N	300 x 700 cm	€ tbc	2	2	32





# DECK

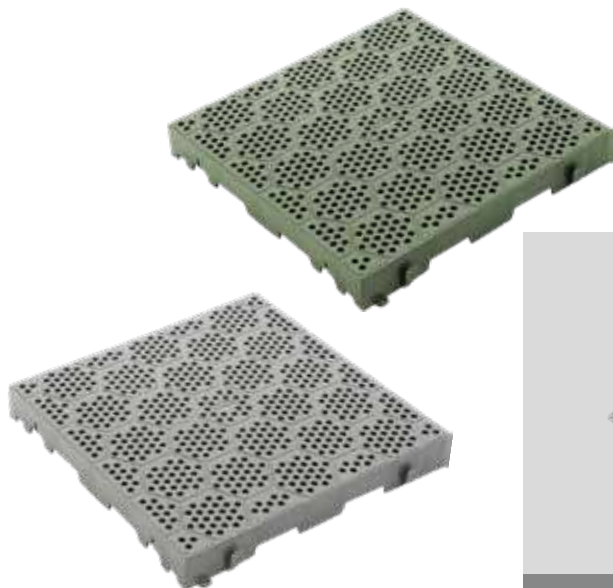



## DECK-FIT

Art. 0201032N

€ tbc

120 / 120 / 120

 38,5 x 38,5 x H5 cm

 1,2 kg

 PP / PE

 4,5 t/m<sup>2</sup>

 **made in EU** COLORS  

Mattonelle Deck-Fit in materiale plastico per la realizzazione di pavimentazioni esterne di vario tipo.

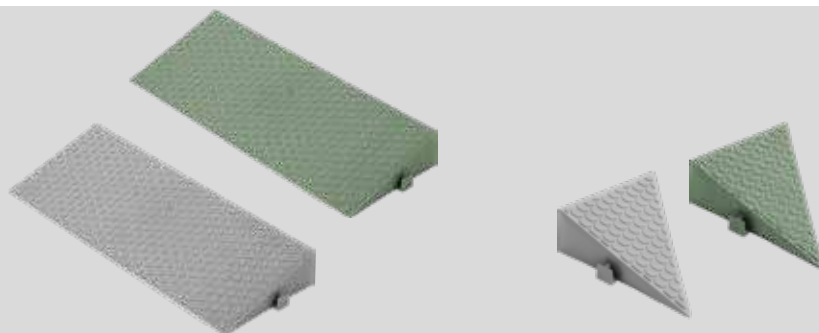

## OPTIONAL

## DECK RAMP

Art. 0201033N



€ tbc

4 / 40 / -

 38,5 x 15 x H5 cm

 220 g

 100% PP

 **made in EU** COLORS  

Rampa laterale per mattonelle Deck-Fit. Con elementi di collegamento.

## DECK CORNER

Art. 0201036N



€ tbc

2 / 2 / -

 20,5 x 15 x H5 cm

 60 g

 100% PP

 **made in EU** COLORS  

Angolare per mattonelle Deck-Fit.





## HELLO



## HELLO CAMPER

Art. 0201034N.CA

€ tbc  
5 / 15 / -

✂ 25 x 50 cm

◆ 100% PP



## TRIMMAT S

Art. 0201037N

€ tbc  
5 / 15 / -

✂ 25 x 50 cm

◆ RUBBER

## ZERBY

Art. 7225150N

€ tbc  
6 / 12 / -

✂ 34 x 27,5 x 6 cm

📦 980 g

## HELLO CARAVAN

Art. 0201034N.CV

€ tbc  
5 / 15 / -

✂ 25 x 50 cm

◆ 100% PP



## TRIMMAT L

Art. 0201038N

€ tbc  
5 / 10 / -

✂ 40 x 60 cm

◆ RUBBER

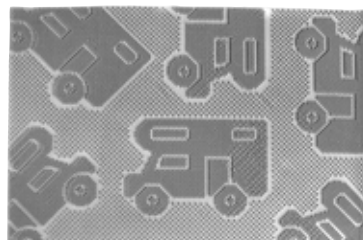

Pratico zerbino con simpatici motivi legati al camper e alla caravan. Protegge gli interni del mezzo da terra, polvere e sporco. Dotato di rivestimento inferiore antisdrucciolo.

Pratico zerbino realizzato in gomma molto resistente. Ideale per l'uso esterno. Colore grigio.

Zerbino con struttura in legno.



# ACAPULCO



M.O. Master

Art. 7233100N	56 x 185 cm	€ tbc	6	18	54
Art. 7233105N	56 x 205 cm	€ tbc	6	18	54
Art. 7233101N	70 x 205 cm	€ tbc	6	18	24
Art. 7233102N	100 x 205 cm	€ tbc	4	12	24



Tendina in ciniglia di ottima qualità per tempo il libero, la casa e il giardino.

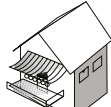
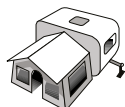
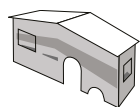
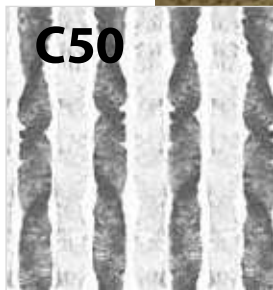
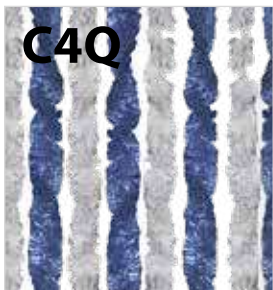
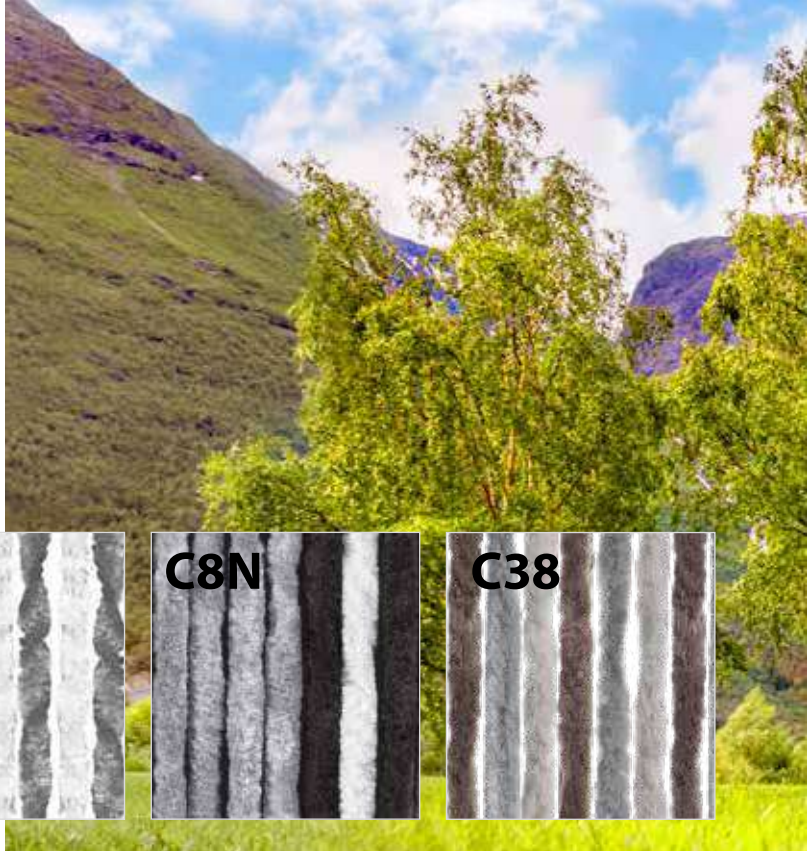

# MEANDER

Art. 7232149N

€ tbc

12 / 48 / 96

60 x 190 cm

100% PVC

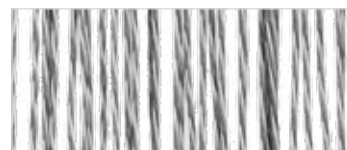

Tendina in plastica con filamenti intrecciati.





# ACAPULCO



## ZANZIBAR S

Art. 7232150N

€ tbc  
8 / 8 / -
 56 x 185 cm

 100% PP

## ZANZIBAR L

Art. 7232152N

€ tbc  
8 / 8 / -
 100 x 200 cm

 100% PP

## RIBBON

Art. 7232154N

€ tbc  
6 / 48 / 96
 60 x 190 cm

 100% PVC

Tenda antizanzare dai molteplici impieghi.

Tenda per porte realizzata in materiale plastico PVC 100% riciclabile.



# LAMPS & LANTERNS



LANTERNE CAMPING  
LAMPADRE PER TENDE  
LAMPADRE FRONTALI





NEW  
2023

## LAMPARINA

Art. 0720068N

€ tbc  
12 / 24 / -

3,7V Li-Ion - 4000mAh

120 lumen

15h

Tungsten Led bulb

Ø 10,3 x H16,4 cm

375 g

6W



Energy class  
in process of approval



Lanterna ricaricabile per Outdoor e Camping dal look professionale. Dona una luce piacevole grazie all'illuminazione a LED selezionabile tra il bianco neutro ed il bianco caldo. Dotata di 2 livelli di intensità luce e di uno schermo in materiale plastica traslucente. Con pratica maniglia in acciaio per il trasporto o per appenderla. La batteria integrata agli ioni di litio può essere ricaricata con il cavo USB in dotazione.



NEW  
2023

## LYSS

Art. 0720066N

€ tbc  
6 / 12 / -

18650 Li-ion - 5200mAh

15-450 lumen

6-200 h

30

Ø 12,6 x H30,5cm (included handle)

560 g

8W



Energy class  
in process of approval



Elegante lanterna LED con resistente struttura realizzata in metallo verniciato, base in bambù e schermo traslucido in materiale plastico. Dotata di interruttore dimmer ON-OFF con 2 modalità di illuminazione: una a luce calda ed una a luce bianca. La batteria integrata agli ioni di litio può essere ricaricata con il cavo USB in dotazione. Utilizzabile in molteplici applicazioni.

# INFO



LED - (Light Emitting Diode) fanno parte del gruppo dei semiconduttori ed hanno un consumo ridottissimo di energia (solo il 5-10% di una normale lampadina ad incandescenza), sono molto resistenti ed eccellono per la loro lunghissima durata (in media oltre 10 anni). Il cono luce prodotto dai LED si è dimostrato molto vantaggioso per la maggior parte delle applicazioni possibili. Inoltre risulta essere più piacevole per l'occhio umano rispetto al raggio concentrato puntiforme delle tradizionali torce elettriche che sono comunque ottime per illuminare a lunga distanza.





## BLAZE RG LED

Art. 0720032N

€ tbc  
6 / 12 / -

- 3,7V / 4000mAh RG Li-Ion
- 600 lumen
- 12 h
- 4
- Ø 130 x H210 mm
- 900 g
- 20W



Energy class  
in process of approval



### 4 BRIGHTNESS LEVELS

Potente lanterna a LED indipendente o da appendere con robusto involucro in plastica per una posizione sicura e stabile. Con maniglia in metallo per il trasporto. 4 livelli di luminosità. Questa lanterna è adatta per una varietà di funzioni come il campeggio, la speleologia, la pesca ed altre attività all'aria aperta.

#### CARATTERISTICHE:

- Batterie ricaricabili
- Con presa USB



## MIZAR

Art. 0720062N

€ tbc  
12 / 24 / -

- 3xAA (1,5V) not incl.
- 90 lumen
- 16h
- 1
- 4,7 x 4,7 x H9/15 cm
- 100 g



Lantern LED, molto compatta quando richiusa. Corpo lanterna in ABS. Leggera e semplice da riporre. Completa di interruttore ON/OFF con modalità Flash, gancio per appenderla e magnete di fissaggio. Funzionamento a batteria.



## ALTAIR

Art. 0720064N

€ tbc  
4 / 12 / -

- 3,7V / 4200mAh Li-Ion RG
- 200 lumen
- 40h
- 1 x 5W
- Ø 13 x H25 cm
- 700 g



Energy class  
in process of approval



Lantern Outdoor ricaricabile dotata di potente LED da 5W. Corpo lanterna in ABS con paralume in resistente policarbonato. Completa di interruttore ON/OFF con regolazione di luminosità e pratica maniglia per il trasporto.



## POLLUX

Art. 0720063N

€ tbc  
12 / 48 / -

- 1800mAh Li-Ion
- 40-150 lumen
- 8h
- 6
- 8,6 x H5,7/14 cm
- 177 g
- 1W



Energy class  
in process of approval



Lantern solare LED con paralume collassabile. Molto compatta quando richiusa. Leggera e semplice da riporre. Completa di interruttore ON/OFF e gancio per appenderla. Si ricarica mediante cellula fotovoltaica integrata o presa USB.





### ARKA

Art. 0720040N

€ tbc  
6 / 12 / -

- 3xD (not incl.)
- 72 lumen
- 15h
- 12
- Ø 8,5 x H19,5/27,5 cm
- 385 g



Lanterna da campeggio LED con alimentazione a batteria.



### LYRA

Art. 0720028N

€ tbc  
4 / 8 / -

- 4xD
- 120 lumen
- 15h
- 20
- Ø 11,5 x H31/25,5 cm
- 700 g



Lanterna LED a batteria.



### GEMINI

Art. 0720029N

€ tbc  
8 / 8 / 96

- 12V - 220V RG Ni-Mh - Solar 4W
- 200 lumen
- 10h
- 15
- Ø 15,7 x H34/26 cm
- 1,5 kg



Energy class  
in process of approval



**RECHARGEABLE**  
12V / 220V



### QUASAR LED 20 RG

Art. 0720053N

€ tbc  
4 / 8 / -

- RG 4V/3,5Ah Sealed Acid Battery
- 120 lumen
- 12h
- 20
- Ø 13 x H29 cm
- 1,25 kg



Energy class  
in process of approval



**RECHARGEABLE**  
12V / 220V

Lanterna LED solare per Outdoor, caravanning e altre attività notturne.

Lampada outdoor resistente all'acqua con lampadina LED ad alto potenziale.



### NEXUS LED

Art. 0720065N

€ tbc  
10 / 100 / -

- USB plug 5V
- 200 lumen
- 6
- Ø 5 cm / 2m power line / 20cm connection line
- 100 g
- 5W



Energy class  
in process of approval



**Lampada Outdoor a LED con cavi USB integrati che consentono di collegare tra loro, in serie, fino a 4 luci. Luminosa e leggera, la lampada a catena fornisce 200 Lumen per l'illuminazione di tende, tende da sole e gazebo. Il paralume regolabile è realizzato in morbido silicone e permette di scegliere tra luce soffusa o spot. Basso consumo energetico per una luce di lunga durata ottenibile da qualsiasi porta USB. Include un moschettone per appendere.**

**CARATTERISTICHE:**

- Corpo lampada: termoplastica con diffusore in silicone
- Diametro lampada: 30 mm
- Collegamento elettrico: tramite spina USB
- Collegamento in serie: tramite connettore USB femmina



## NOCTILUS

Art. 0720060N

€ tbc  
12 / 72 / -

- 3xAA (not incl.)
- 20 lumen
- 45h
- 5
- Ø 7,8 x H5,4 cm
- 65 g



Lampada LED a sospensione per illuminare l'interno di tende a 360°. Funzionamento a batteria.



## LUMINA

Art. 0720061N

€ tbc  
8 / 32 / -

- 1xAA (not incl.)
- 25 lumen
- 8h+
- 1
- Ø 6 x H10,5 cm
- 60 g
- 0,5W



Lampada per tende con interruttore a 3 livelli di luminosità e pratico gancio per appendere.



## GLOBE LED

Art. 0720009N

€ tbc  
10 / 50 / -

- 3,7V 2400mAh
- 98-394 lumen
- 8-15 h
- 42
- Ø 10,4 x H17,3 cm
- 180 g
- 21W



Energy class  
in process of approval



RECHARGEABLE

Lampada LED a basso consumo energetico realizzata con corpo in resistente ABS e schermo in materiale plastico trans lucente che genera una luce uniforme. Il pulsante ON-OFF integrato permette di selezionare più livelli di intensità luce per illuminare l'ambiente circostante in maniera ottimale. Completa di gancio in metallo per appenderla e presa Micro-USB per la ricarica. Facile da trasportare grazie alle sue dimensioni compatte. Ottima per l'utilizzo Outdoor e Camping.

## TABIT

Art. 0720012N

€ tbc  
20 / 60 / -

- 3xLR3/AAA (not incl.)
- 39 g
- 75 lumen
- 3



### RED LIGHT



### WHITE LIGHT



Lampada frontale ultraleggera e molto compatta. Funzionamento a batteria.

#### CARATTERISTICHE:

- Lampada frontale LED con luce bianca (2X) rossa (1X)
- Riflettore orientabile
- Cinghia di fissaggio regolabile





## SYRMA LED

Art. 7521018N

€ tbc  
5 / 20 / -

Ø 18,5 X H12 cm

350 g

230 V

520 lumen

32

15W

COLORS



**DIMMERABLE**  
0-100%



## SIXRAY

Art. 7521011N

€ tbc  
6 / 6 / -

Ø 50 x H25 cm

400 g

230V AC

250 lumen

5W

3h

COLORS



**Lampada LED per tende e verande. Corpo pieghevole in silicone (sistema Fold-Away).**

### CARATTERISTICHE:

- Corpo in silicone
- Moderna tecnologia LED per oscuramento graduale (dimmer)
- Con gancio di sospensione e cavo di collegamento da 5 m
- Sistema di regolazione dell'altezza
- Interruttore ON-OFF

Lampadario ad ombrello a sei raggi completo di lampadina LED a bulbo con batteria ricaricabile integrata. Completo di cavo di collegamento e interruttore ON/OFF.



## JABBA RG LED

Art. 0720006N

€ tbc  
20 / 100 / -

3,7V / 1200mAh lithium - 18650 RG

60 x 40 x 35 mm

74 g

1

3W



RED LIGHT



WHITE LIGHT



SENSOR  
RECEIVER

**Lampada frontale LED ricaricabile con riflettore orientabile. Attivazione manuale o senza contatto mediante sensore. La moderna tecnologia LED fornisce una luce molto intensa.**

### CARATTERISTICHE:

- Attivazione manuale (con pulsante) o senza contatto mediante sensore
- Ricaricabile con batterie integrate
- Riflettore orientabile
- Strisce riflettenti sulla fascia
- Corpo in resistente materiale plastico
- Viene fornito con cavo di ricarica Micro-USB





# SLEEP & RELAX



**SACCHILETTO  
MATERASSINI  
AMACHE**





## INFO

## SACCO A PELO

Il sacco a pelo è uno degli elementi più importanti dell'attrezzatura outdoor. Solo chi dorme e riposa bene può recuperare durante la notte ed iniziare il nuovo giorno in piena forma. La funzione di un sacco a pelo è relativamente semplice: conservare il calore del corpo e creare un clima piacevole all'interno del sacco stesso. I sacchi a pelo con imbottitura in fibra sintetica sono caratterizzati dal fatto che assorbono solo piccole quantità di umidità. Essi sono quindi adatti per l'uso in paesi o regioni con elevata umidità relativa ed un'alta probabilità di precipitazioni. Inoltre, il loro prezzo è solitamente più contenuto. I sacchi a pelo in piumino d'oca invece hanno più difficoltà con alti livelli di umidità. L'imbottitura rischia di diventare grumosa e quindi perdere il suo Loft e le sue proprietà di isolamento altrimenti eccellenti. Tuttavia, questo tipo di sacchi a pelo si distingue per il suo peso ridotto, la dimensione molto compatta quando chiusi ed il lungo ciclo di vita (se utilizzati e conservati correttamente).



## DELPHIN 90

Art. 0428022N

€ tbc  
3 / 3 / -

- 230 x 85 cm
- 50 x 45 x 23 cm
- 2,1 kg
- 1
- 100% Cotton
- 20D 380T Nylon
- 900g Microfiber 100% - Polyester
- 12 / 3 / 7

## DELPHIN 150

Art. 0428027N

€ tbc  
3 / 3 / -

- 230 x 90 cm
- 48 x 46 x 27 cm
- 3 kg
- 1
- 100% Cotton
- 20D 380T Nylon
- 1550g Microfiber 100% - Polyester
- 26 / -8 / -2

## DELPHIN DOUBLE 270

Art. 0428028N

€ tbc  
2 / 2 / -

- 230 x 160 cm
- 52 x 52 x 30 cm
- 5,1 kg
- 1
- 100% Cotton
- 20D 380T Nylon
- 2700g Microfiber 100% - Polyester
- 24 / -6 / 0



2-way zipper



Carry bag

La collezione Delphin offre fantastici sacchi a pelo con cappuccio realizzati con materiali di alta qualità per garantire durata, comfort e leggerezza. L'imbottitura è costituita da fibre cave che catturano il calore nel sacco a pelo e mantengono il corpo caldo e confortevole. Ideale per il campeggio, le attività all'aperto e persino per i camper e le tende da tetto.

### CARATTERISTICHE:

- Peso ridotto
- Struttura ad 1 strato
- 2 intervalli di temperatura in base al modello
- Cappuccio staccabile (cerniera)
- Può essere usato come coperta quando è aperto
- Cerniera: YKK a 2 vie - Autolock- forma a L
- Predisposto per lenzuolo interno
- Senza PFC
- Con borsa rettangolare per il trasporto







I sacchi a pelo Vandora sono il compagno ideale per tutti i luoghi in cui lo spazio è ridotto, ad esempio nei van, nei minibus o nelle tende a tetto. Tuttavia, i due modelli di questa collezione offrono molto spazio e libertà di movimento per mettersi a proprio agio, oltre alla possibilità di aprirli come una coperta e, non da ultimo, un formato molto compatto una volta riposti nei loro sacchi di compressione. Entrambi i sacchi a pelo hanno una pratica tasca per il cuscino nel cappuccio e una tasca interna per i piccoli oggetti.

#### CARATTERISTICHE:

- Dimensioni compatte
- Struttura a 1 strato
- 2 intervalli di temperatura in base al modello
- Cappuccio staccabile (cerniera)
- Può essere usato come coperta quando è aperto
- Cerniera: YKK a 2 vie - Autolock - forma a L
- Predisposto per lenzuolo interno
- Senza PFC
- Con sacco a compressione

## VANDORA 35

Art. 0428034N

	220 x 80 cm
	Ø 17 x H 18 cm
	915 g
	1
	100% Cotton
	300T Polyester
	350g Microfiber 100% - Polyester
	-2 / 9 / 13

€ tbc  
4 / 4 / -

## VANDORA 70

Art. 0428035N

	220 x 80 cm
	Ø 22 x H 18 cm
	1,2 kg
	1
	100% Cotton
	300T Polyester
	700g Microfiber 100% - Polyester
	-10 / 4 / 8

€ tbc  
4 / 4 / -



2-way zipper



Carry bag







NEW  
2023



## NEMOS 120

Art. 0428031N

€ tbc  
3 / 3 / -

-  235 x 90 cm
-  48 x 46 x 23 cm
-  2,4 kg
-  2
-  Flannel
-  110/76 80/20TC
-  1200g Microfiber 100% - Polyester
-  -15 / 0 / 5

Il sacco a pelo Nemos 120 è un'ottima scelta per chi cerca il riposo perfetto. Offre praticamente tutto ciò che si può desiderare da un sacco a pelo per le attività outdoor. La classica forma rettangolare offre molto spazio e facilità di movimento. Allo stesso tempo, la fodera in flanella assicura una sensazione di comfort. L'intervallo di temperatura coperto dall'isolamento sintetico di alta qualità è ideale per le attività outdoor dalla primavera all'autunno. E se dovesse fare troppo caldo, la cerniera a L a due vie consente una piacevole ventilazione.

### CARATTERISTICHE:

- Sacco a pelo grande con cappuccio
- Costruzione a 2 strati sfalsati
- Può essere utilizzato come coperta quando è aperto
- Cuscino integrato
- Cappuccio staccabile (cerniera)
- Cerniera: YKK a 2 vie - Autolock- forma a L
- Predisposto per lenzuolo interno
- Accoppiabile
- Senza PFC
- Con borsa rettangolare per il trasporto

## NEMOS 160

Art. 0428032N

€ tbc  
3 / 3 / -

-  235 x 90 cm
-  48 x 46 x 27 cm
-  3 kg
-  2
-  Flannel
-  110/76 80/20TC
-  1600g Microfiber 100% - Polyester
-  -28 / -9 / -3

Per i campeggiatori più esigenti, il sacco a pelo rettangolare Nemos 160 è il partner ideale. Una scelta selettiva di materiali adatti assicura che l'utente sia tenuto al caldo in tutte e 4 le stagioni, fornendo allo stesso tempo una piacevole sensazione di comfort e benessere nelle notti più fredde. Se necessario, è possibile collegare 2 sacchi a pelo tramite una zip per formare un sacco a pelo doppio.

### CARATTERISTICHE:

- Sacco a pelo confortevole ed efficiente dal punto di vista del calore con cappuccio
- Costruzione offset a 2 strati
- Può essere utilizzato come coperta quando è aperto
- Cuscino integrato
- Cappuccio staccabile (cerniera)
- Cerniera: YKK a 2 vie - Autolock- forma a L
- Predisposto per lenzuolo interno
- Accoppiabile
- Senza PFC
- Con borsa rettangolare per il trasporto

## Pillow pocket

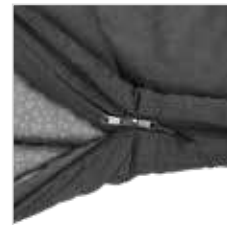
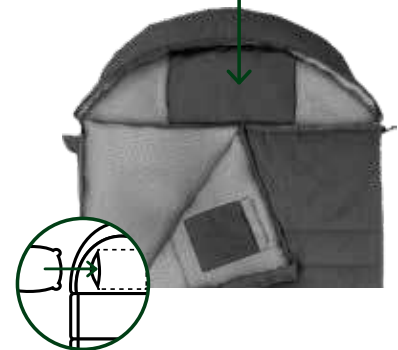

Can be coupled



Carry bag



NEW  
2023Detachable  
hood

Can be coupled



Carry bag

NEW  
2023

Pillow pocket

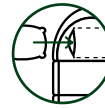
NEW  
2023

## STARFLYER

Art. 0428038N

€ tbc  
4 / 4 / -

220 x 85 cm

Ø 42 x H22 cm

1,5 kg

2+1

100% Cotton

240T Nylon Ripstop

1000g Microfiber 100% - Polyester

Cold side -13 / 2 / 7 - Hot side 2 / 12 / 16

## STARFLYER XL

Art. 0428039N

€ tbc  
2 / 2 / -

235 x 85 cm

Ø 47 x H 26 cm

1,95 kg

2+1

100% Cotton

240T Nylon Ripstop

1700g Microfiber 100% - Polyester

Cold side -16 / 1 / 4 - Hot side 0 / 11 / 14

## STARFLYER DOUBLE

Art. 0428040N

€ tbc  
1 / 1 / -

220 x 145 cm

Ø 48 x H31 cm

3,2 kg

2+1

100% Cotton

240T Nylon Ripstop

2400g Microfiber 100% - Polyester

Cold side -22 / -5 / 1 - Hot side -3 / 8 / 12

**Sacco a pelo leggero e confortevole per le notti estive e i soggiorni in camping. I due strati di imbottitura offrono un calore piacevole e accogliente per tutta la notte. Quando lo spazio è limitato, il cuscino integrato e il sacco di compressione incluso semplificano il trasporto. Cappuccio con cerniera. Il sacco a pelo Starflyer può essere facilmente trasformato in una coperta.**

### CARATTERISTICHE:

- Sacco a pelo rettangolare leggero per le notti estive
- Reversibile
- Struttura a 2 strati sul lato superiore - struttura a 1 strato sul lato inferiore
- Imbottitura molto morbida
- Utilizzabile dalla tarda primavera all'inizio dell'autunno (2/3 stagioni)
- Cappuccio staccabile (cerniera)
- Può essere utilizzato come coperta quando è aperto
- Cuscino integrato
- Cerniera: YKK a 2 vie - Autolock- L-shape
- Accoppiabile
- Predisposto per lenzuolo interno
- Senza PFC
- Con sacca di compressione

**Grazie alle sue dimensioni spaziose di 2,35 m di lunghezza, questo modello è particolarmente adatto alle persone più alte. Morbido e accogliente assicura sempre un sonno confortevole e può essere utilizzato sia all'aperto che al chiuso dalla primavera all'autunno (3 stagioni). In caso di basse temperature, il cappuccio può essere chiuso con una zip, mentre il comodo cuscino integrato evita di dover portare con sé un cuscino separato. Con un peso inferiore a 2 kg e la sacca di compressione inclusa, il sacco a pelo è caratterizzato da dimensioni particolarmente compatte che lo rendono facile da trasportare.**

### CARATTERISTICHE:

- Grande sacco a pelo rettangolare per persone alte
- Reversibile
- Struttura a 2 strati sul lato superiore - struttura a 1 strato sul lato inferiore
- Imbottitura molto morbida
- Utilizzabile dalla primavera all'inizio dell'inverno (3 stagioni)
- Cappuccio staccabile (zip)
- Può essere utilizzato come coperta quando è aperto
- Cuscino integrato
- Cerniera: YKK a 2 vie - Autolock - forma a L
- Senza PFC
- Con sacca di compressione

**È il più simile possibile al letto di casa, ma è stato progettato per tenere caldo anche nei periodi più freddi. Il sacco a pelo matrimoniale Starflyer Double offre molto spazio alle coppie di campeggiatori e camperisti che desiderano un posto comodo e accogliente per dormire dalla primavera all'autunno inoltrato. Due cuscini integrati nel cappuccio eliminano la necessità di portare con sé cuscini separati. Un pratico sacco di compressione è incluso per dare al sacco a pelo Starflyer Double un ingombro particolarmente ridotto.**

### CARATTERISTICHE:

- Sacco a pelo doppio con cappuccio - forma rettangolare
- Struttura a 2 strati sul lato superiore - struttura a 1 strato sul lato inferiore
- Imbottitura molto morbida
- Utilizzabile dalla primavera all'inizio dell'inverno (3 stagioni)
- Cappuccio rimovibile (cerniera)
- Cuscini integrati
- Cerniera: YKK a 2 vie - Autolock - forma a L
- Predisposto per lenzuolo interno
- Senza PFC
- Con sacca di compressione



2-way zipper



Carry bag

## PELICAN XL

Art. 0428004N.L  
Art. 0428004N.R

€ tbc  
4 / 8 / 48



-10°C | +2°C  
+6°C | +20°C

**Sacchetto a coperta XL molto grande per tanta libertà nel movimento mentre si dorme.**

### CARATTERISTICHE:

- Cerniera a doppia direzione
- Abbinabile dx-sx
- Copricerniera
- Sacca custodia
- Sacco letto 2 stagioni

- ✂ 200 x 90 cm
- 📏 Ø 25 x 42 cm
- 📖 1,77 kg
- 📄 1
- 🧶 Soft Polycotton
- 🧶 Ripstop Polyester
- 🛏 PES Hollowfibre 250 g/m<sup>2</sup>



2-way zipper



Carry bag

## HUSKY 300

Art. 0428021N

€ tbc  
6 / 6 / 36

-10°C | +2°C  
+6°C | +20°C

Sacchetto a coperta, con interno in caldissima flannela di cotone.

- ✂ 200 x 90 cm
- 📏 Ø 26 x 48 cm
- 📖 2,20 kg
- 📄 2
- 🧶 Flannel
- 🧶 Ripstop Polyester
- 🛏 2x 150 g/m<sup>2</sup> PES Hollowfibre

## LINEAR RECTANGULAR

Art. 0428140N

€ tbc  
10 / 20 / -

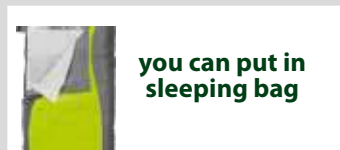

you can put in sleeping bag



Saccolenzuolo rettangolare in cotone con tasca per cuscino.

- ✂ 230 x 80 cm
- 📖 300 g
- 🧶 100% Cotton



## INDIAN

Art. 0428033N

€ tbc  
5 / 10 / -

- ✂ 200 x 150 cm
- 📏 Ø 18 x 35 cm
- 📖 750 g
- 🧶 Fleece 100% Polyester



Confortevole coperta in pile realizzata al 100% in morbidissimo tessuto di poliestere.





2-way zipper

Carry bag

**LAGUNA LITE**

Art. 0428003N

€ tbc  
7 / 14 / -

+10°C / +25°C

Sacchetto a coperta estivo ed ultraleggero. Completo di pratico cappuccio.

- 185+25 x 75 cm
- Ø 14 x 24,5 cm
- 720 g
- 1
- Technical Cotton
- 190T Polyester
- 80 g/m<sup>2</sup> - Silk-like fiber



2-way zipper

Carry bag

**ARGOS**

Art. 0428014N

€ tbc  
6 / 6 / 48

-10°C / 0°C / +5°C

Sacchetto XL a coperta ultraleggero con morbidissima imbottitura Feathersoft.

- 200+35 x 90 cm
- Ø 12 x 38 cm
- 1,5 kg
- 1
- Flannel
- Ripstop Polyester
- 100% PES 200 g/m<sup>2</sup>





# ALVEOMAT

Termomaterassini autogonfianti con telo in poliesterе antisdruciuolo, di estrema comodità ed ottima isolamento. Sono inclusi un set di riparazione e una sacca custodia.

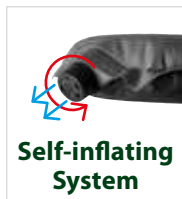

Self-inflating System



5 cm

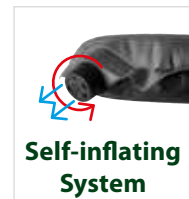

Self-inflating System



7 cm

## ALVEOMAT 5

Art. 0412038N

€ tbc  
6 / 6 / 60

198 x 63 x 5 cm

2,15 kg

70 x Ø 15 cm

100% Polyester

## ALVEOMAT 7 COMFORT

Art. 0412040N

€ tbc  
4 / 4 / 48

198 x 76 x 7 cm

3,90 kg

74 x Ø 19 cm

100% Polyester

# ALVEOBED

I materassi ad aria Alveobed sono ideali compagni di viaggio durante attività Outdoor di ogni genere. Sacca custodia inclusa.

### CARATTERISTICHE:

- Facile da usare
  - Dimensioni d'imballo salvaspazio
  - Resistente alle temperature
  - Robusto e resistente
  - Con pratica valvola Boston (Alveo Single, Alveo Double)
- \* sgonfio



## ALVEOBED SINGLE

Art. 0412027N

€ tbc  
6 / 6 / -

220 x 75 cm\*

1,45 kg

Ø 12,5 x 28 cm

100% Polyester 190T/75D PVC Coating

## ALVEOBED DOUBLE

Art. 0412028N

€ tbc  
4 / 4 / 48

220 x 142 cm\*

3,3 kg

Ø 25 x 36 cm

100% Polyester 190T/75D PVC Coating



BOSTON VALVE





### INTEGRATED CUSHION





**AIR  
PUMP  
SYSTEM**

## MOFLATE

Art. 0412022N

€ tbc  
4 / 16 / -

 200 x 70 x H8 cm

 900 g

 27 x Ø 11,5 cm

 40D Nylon / DPU

Materassino gonfiabile ultraleggero e super-compatto con pompa di gonfiaggio integrata. Ideale per tutte le attività outdoor e camping che richiedono un pernottamento. Ottima isolazione dall'umidità del terreno grazie alla speciale conformazione delle camere d'aria. Completo di sacca custodia.





## ALVEOBED SINGLE IP

Art. 0412039N

€ tbc  
6 / 6 / 96

 220 x 75 cm\*

 1,45 kg

 Ø 12,5 x 28 cm

 100% PES / PVC Coating

## SIX MAT

Art. 0412036N

€ tbc  
6 / 12 / -

 185 x 70 cm\*

 780 g

 Ø 18 x 32 cm

 100% Polyester

Materassino ultra leggero in poliestere antisdrucciolo di alta qualità. Costruzione a sei tubi. Con sacchetto custodia. \* sgonfio

## ALVEOBED PILLOW

Art. 0412029N

€ tbc  
12 / 12 / -

 60 x 40 cm

 200 g

 Ø 5 x 21 cm

 100% Polyester 190T/75D TPU Coating

Cuscino Outdoor di alta qualità. Con borsa custodia.



**AIR  
PUMP  
SYSTEM**



# SOMNI 3D



Front

Back



Front

Back

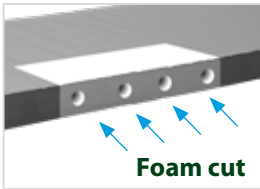

Foam cut





Self-inflating System

## SOMNI 3D SINGLE

Art. 0432085N

€ tbc  
4 / 4 / -

 200 x 76 x 10 cm

 3,2 kg

 Ø 19 x 79 cm

 190T 75D Polyester

## SOMNI 3D DOUBLE

Art. 0432089N

€ tbc  
2 / 2 / -

 200 x 132 x 10 cm

 5,7 kg

 Ø 27 x 68 cm

 190T 75D Polyester

Materasso autogonfiante di nuova concezione. Molto confortevole, con un eccezionale rapporto tra peso complessivo e materiale isolante ottenuto mediante l'utilizzo di uno strato continuo di schiuma isolante in cui scorrono i flussi d'aria orizzontali. Realizzato in tessuto in poliestere con rivestimento superiore ad effetto peach skin. Ideale per un riposo ottimale. Grazie ad una particolare valvola bidirezionale, che al bisogno blocca o permette il flusso d'aria, il materasso si gonfia autonomamente. Per sgonfiarlo è sufficiente arrotolarlo chiudendo la valvola a fine operazione, sarà quindi poi riponibile occupando poco spazio. Completo di sacca custodia. Disponibile in 2 misure.





# FLAIR

I nostri materassini ad aria Flair sono realizzati con una soffice superficie in velluto e di resistente PVC. Dispongono di grosse valvole per un rapido gonfiaggio e sgonfiaggio. Ideali come letto per ospiti o per il campeggio.  
\* sgonfio



**SINGLE GREY**



**SINGLE BLUE**



**DOUBLE GREY**



**DOUBLE BLUE**



**JUMBO**

included only  
for Jumbo



						M.O.	Master	
SINGLE BLUE	Art. 0432080N.C30	191 x 73 x 22 cm*	1,68 kg	100% PVC	€ tbc	6	6	-
DOUBLE BLUE	Art. 0432082N.C30	191 x 137 x 22 cm*	2,96 kg	100% PVC	€ tbc	4	4	80
SINGLE GREY	Art. 0432080N.C06	191 x 73 x 22 cm*	1,68 kg	100% PVC	€ tbc	6	6	-
DOUBLE GREY	Art. 0432082N.C06	191 x 137 x 22 cm*	2,96 kg	100% PVC	€ tbc	4	4	-
JUMBO	Art. 0432086N	203 x 157 x 38 cm*	4,96 kg	100% PVC	€ tbc	2	2	-

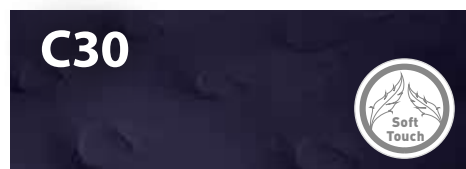

## INFO MATERASSINI AD ARIA

I materassini ad aria, conosciuti anche come materassini gonfiabili, sono una comoda opportunità di riposo a basso costo per tutti i campeggiatori. Sono adattabili individualmente, proteggono tutto il corpo e consentono un sonno rilassato. Nell'assortimento Brunner sono presenti due tipi di materassini (materassini in PVC con superficie vellutata e materassini in cotone gommato). Entrambi i modelli sono disponibili in varie misure per soddisfare sia adulti che bambini, ma anche le coppie. Gli svantaggi dei materassini ad aria sono il loro peso, la dimensione d'imballo ed il fatto che prima dell'uso debbano essere gonfiati (non dimenticare la pompa d'aria). I materassini ad aria con superficie vellutata sono adatti anche per casa come letto d'emergenza per amici e parenti. Da considerare che i materassini ad aria non sono adatti all'utilizzo in acqua. Per questi casi esistono semplici materassini in PVC.



## WHISPER

Art. 0436003N

€ tbc  
6 / 6 / 60

- 2x 2000 CC
- 12 x 22 x 45 cm
- 800 g

Pompa doppia azione.  
Con set adattatori.



## WHISPER ALU

Art. 0436002N

€ tbc  
6 / 6 / 60

- 1x 3000 CC
- 10 x 22 x 54 cm
- 1,2 kg

Pompa aria con pistone in alluminio e  
set adattatori.



## SUSSURRO

Art. 0436006N

€ tbc  
12 / 24 / -

- 5000 CC
- 650 g

Gonfiatore a mantice con robuste basi antiscivolo in materiale plastico. Completo di adattatori.



## INFLATOR

Art. 0436010N

€ tbc  
4 / 20 / -

- 12 x 10 x H11,5 cm
- 230 g
- 12V DC
- 75W

l/min 20 l/min

Gonfiatore e sgonfiatore elettrico 12V con  
interruttore ON/OFF completo di 3 adattatori.



## TEMPEST RG USB

Art. 0436016N

€ tbc  
10 / 20 / -

- 8 x 7,5 x 10,5 cm
- 280 g
- RG
- 38 W

l/min 270 l/min

Potente pompa 5V con interruttore ON-OFF.  
Completa di adattatore USB. Con borsa.



# MEMO

Cuscino compatto in speciale schiuma ad alta densità Memory Foam.



CORRECT  
SLEEPING  
POSITION



## MEMO TRAVEL

Art. 0434009N

€ tbc  
5 / 20 / -

37 x 28 x 10 cm

460 g

100% Polyester + Aloe Vera



## MEMO CAMPER

Art. 0434010N

€ tbc  
5 / 10 / 80

50 x 30 x 10/7 cm

700 g

75% Cotton 25% PES + Aloe Vera



COLORS



## MORGAN

Art. 0434015N

€ tbc  
10 / 40 / -

47,5 x 32,5 x H11,5 cm

120 g

100% PVC



BACK

## NANNA

Art. 0434016N

€ tbc  
10 / 40 / -

41 x 33 cm

150 g

30% Cotton 70% Polyester



REMOVABLE and  
WASHABLE COVER



Cuscino poggiatesta gonfiabile con superficie vellutata piacevole al tatto.

Cuscino poggiatesta gonfiabile con fodera in tessuto misto cotone piacevole al tatto.



# MAT COLLECTION



## SUNRAY

Art. 0412001C

€ tbc  
25 / 50 / -

180 x 50 x 0,7 cm

210 g

100% PE

Materassino bistrato pieghevole in 100% PE. Entrambi i lati lisci.



## ROAMAT

Art. 0412003N

€ tbc  
12 / 12 / 96

180 x 50 x 1,2 cm

390 g

100% EVA

Materassino bistrato in EVA a cellule chiuse.



## KOALA

Art. 0412006N

€ tbc  
30 / 30 / -

180 x 50 x 0,7 cm

190 g

100% EVA

Materassino monostrato in EVA a cellule chiuse. Liscio su entrambi i lati.



## ALU-MAT

Art. 0412017C

PACK 1X

€ tbc  
10 / 40 / -

Art. 0412017N

PACK -

€ tbc  
10 / 50 / -

180 x 50 x 0,7 cm

190 g

100% PE

Materassino monostrato con film alluminizzato e goffatura sul lato superiore. Leggero e compatto.

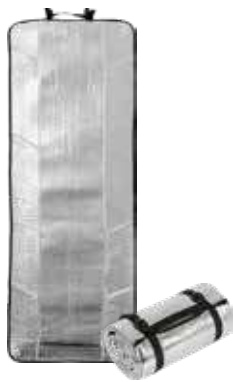

## ALU TRAMP

Art. 0412009N

€ tbc  
6 / 24 / -

190 x 55 x 0,3 cm

138 g

Ø 14 x 29 cm

PE / Alu

Stuoino isolante impermeabile con imbottitura.



## GRENADA

Art. 0412030N

€ tbc  
4 / 4 / 40

183 x 54 x 3 cm

650 g

28 x 54 x 18 cm

30% Cotton 70% Polyester 100% PVC

Materassino da spiaggia imbottito e foderato.



## BONITA

Art. 0412031N

€ tbc  
4 / 8 / 48

140 x 50 x 2 cm

840 g

50 x 23 x 11 cm

100% Polyester Oxford

Materassino con rivestimento in resistente tessuto antisdrucchiolo realizzato in Polyester Oxford.



## TORTUGA

Art. 0412023N

€ tbc  
6 / 12 / 96

193/180 x 60 cm

400 g

Ø 18 x 60 cm

100% Polyester + 100% PE

Comodo materassino da spiaggia in tessuto leggermente imbottito.



## PRAIA

Art. 0412025N

€ tbc  
6 / 12 / -

180 x 85 cm

320 g

Ø 5 x 85 cm

100% PP

Stuoino per spiaggia realizzata in resistente tessuto polipropilenico.



## OASIS ALU

Art. 0412019N

€ tbc  
12 / 24 / -

180 x 80 cm

480 g

Ø 6 x 80 cm

Natural Fiber / Alu Foil

Stuoino spiaggia in fibra vegetale, alluminizzata su un lato.





## CAYO

Art. 0412018N

€ tbc  
12 / 24 / -



Stuoia spiaggia realizzata in tessuto PP flessibile, resistente e idrorepellente. Design moderno. Pratica da riporre e trasportare.

🔒 180 x 200 cm

🔒 37 x 7 x 28 cm

🔍 100% PP

📖 720 g



## PICNIC PLAID

Art. 0428052N

€ tbc  
5 / 10 / -



Coperta picnic leggermente imbottita.

🔒 200 x 150 cm

🔒 38 x 8 x 26 cm

🔍 100% Polyester

📖 870 g



ASSORTED

## ALFRESCO

Art. 0428054N

€ tbc  
6 / 6 / -

Coperta da picnic con superficie soffice e morbida in resistente fibra sintetica idrorepellente. Il lato inferiore ha un rivestimento impermeabile. Con maniglia per il trasporto.

🔒 200 x 150 cm

🔒 30 x 15 x 21 cm

🔍 100% Polyester Fleece / PEVA

📖 500 g



ASSORTED

## TJAGO

Art. 0428061N

€ tbc  
10 / 10 / -



Coperta picnic arrotolabile realizzata in resistente tessuto di poliestere e lato inferiore idrorepellente.

🔒 145 x 200 cm

🔒 34 x 8 x 18,5 cm

🔍 100% Polyester / PEVA

📖 500 gr





# INFO

## IL LETTINO DA CAMPO

I lettini da campo danno la possibilità di dormire in modo comodo e sicuro, ben rialzati dal terreno. Soprattutto in caso di maltempo si è protetti dal bagnato e dall'umidità. Inoltre non si è a contatto con fastidiosi insetti. A seconda del modello di lettino esiste la possibilità di stivare attrezzatura sotto al telo per dormire. Come per ogni acquisto di attrezzatura, sono molte le considerazioni da fare nella scelta di un lettino da campo. Ogni modello presente nel nostro catalogo ha dei vantaggi e svantaggi. E' soprattutto importante ragionare sul mezzo che verrà utilizzato per trasportare il lettino da campo: alcuni diventano molto piccoli perchè si possono scomporre o ripiegare, altri sono solo pieghevoli, con misure meno compatte, ma solitamente più confortevoli.





### OUTDOOR COT

Art. 0410032N.C30

€ tbc

2 / 2 / 38

 190 x 64/72 x H43 cm

 95 x 21 x H14 cm

 4,8 kg



Lettino da campo con struttura pieghevole e smontabile in alluminio.

NEW  
2023





### OUTDOOR COT XL2

Art. 0410045N

€ tbc

2 / 2 / -

 210 x 80 x H50 cm

 103 x 20 x 12 cm

 6,5 kg



Lettino da campo di ampie dimensioni. Telaio in alluminio anodizzato.





### OUTDOOR COT AUTOMATIC

Art. 0410044N

€ tbc

2 / 2 / 20

 191 x 66 x H44 cm

 105 x 15 x 15 cm

 8,9 kg



Lettino da campo robusto con struttura pieghevole appositamente progettata per essere aperta e ripiegata in un istante. Comoda tela in resistente tessuto di poliestere con poggiatesta integrato e imbottito. Di dimensioni compatte quando ripiegato. Con pratica borsa per il trasporto.





# BELHAM

Amaca da viaggio realizzata in tessuto sintetico ultraleggero e super resistente. Dotata di ampia superficie di sdraio ed una capacità di carico massima di 300 kg. Molto compatta da trasportare mediante una pratica sacca custodia inclusa nella fornitura che funge anche da piccola tasca per riporre gli occhiali da sole, il cellulare, gli spiccioli, ecc. Perfetta per outdoor, camping, moto e cicloturismo. Disponibile in versione singola e doppia. Accessori di fissaggio inclusi.



## BELHAM SINGLE

Art. 0414005N

€ tbc  
4 / 20 / -

270 x 140 cm

22 x 14 x 5 cm

500 g

300 kg



## BELHAM DOUBLE

Art. 0414006N

€ tbc  
4 / 20 / -

300 x 200 cm

24 x 16 x 6 cm

710 g

300 kg



## VOYAGER

Art. 0414009N

€ tbc  
6 / 12 / -

(52,5+225+52,5) x 147 cm

21 x Ø 7 cm

380 g

100 kg

Nylon 100% PA



Amaca ultraleggera di dimensioni molto compatte.



# SAMBA



**Metal reinforced knot**

**Durable support ropes**



**Bright colours Soft feel**

## SAMBA

Art. 0414016N.C28

€ tbc  
6 / 12 / -

**WITH BAG**



 (65+210+65) x 140 cm

 34 x Ø 18 cm

 1,7 kg

 100 kg

 Polycotton

Amaca tradizionale in stile brasiliano.

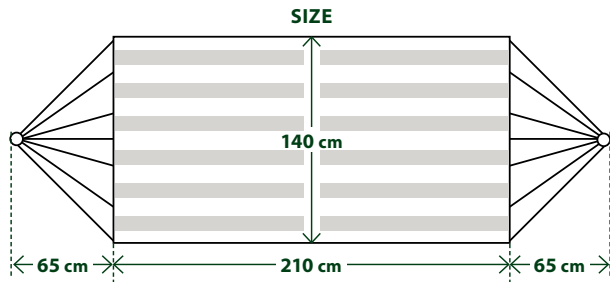

## SAMBA DUO

Art. 0414017N.C28

€ tbc  
6 / 12 / -

**WITH BAG**



 (55+255+55) x 165 cm

 40 x Ø 15 cm

 2,1 kg

 160 kg

 Polycotton

Amaca tradizionale in stile brasiliano.

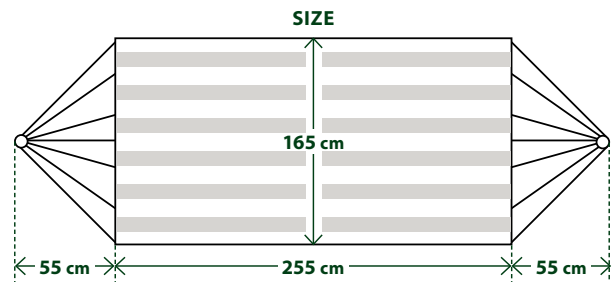



## HAMRO

Art. 0414022N

€ tbc  
6 / 12 / -

 300 cm x 2

 225 gr x 2

 130 kg

Set 2 funi per amache.



# JARDIM



**Metal reinforced knot**

**Durable support ropes**



**Bright colours Soft feel**

**WITH BAG**



## JARDIM

Art. 0414018N

€ tbc  
6 / 12 / -

(40+210+40) x 100 cm

85 x Ø 10 cm

1,6 kg

100 kg

Polycotton



## JARDIM DUO

Art. 0414019N.C28

€ tbc  
6 / 12 / -

(47+206+47) x 160 cm

122 x Ø 12 cm

2,6 kg

130 kg

Polycotton



Comoda amaca con pali divaricatori in legno.

Comoda amaca con pali divaricatori in legno.

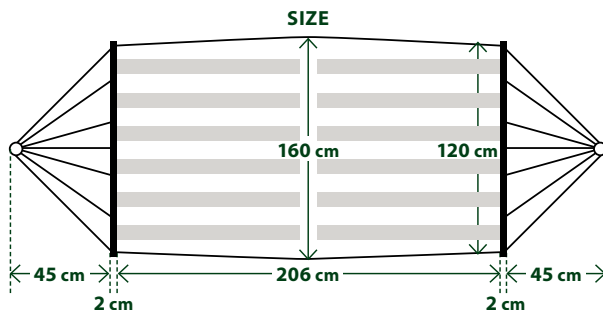
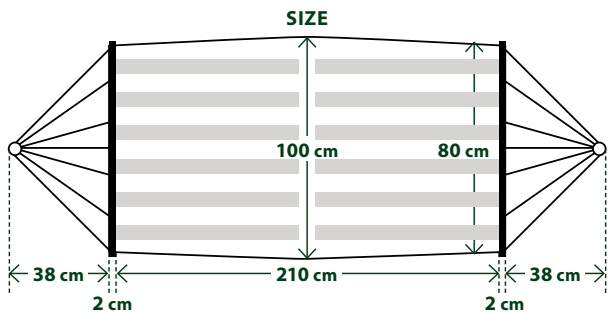



# TRAVEL ACCESSORIES



**BORSE VIAGGIO  
NECESSAIRE  
ACCESSORI VIAGGIO**



## GETAWAY



## GETAWAY

Art. 9003043N

€ tbc  
2 / 2 / 24

✂ 40 x 55 x 25 cm

✓ 45 l

◆ 420D Polyester/PVC

📏 2,8 kg



**Borsa da viaggio di dimensioni compatte con funzione trolley. Ideale per viaggi di 2-3 giorni.**

**CARATTERISTICHE:**

- Tessuto esterno idrorepellente
- Ruote angolari di alta qualità
- Maniglione telescopico a scomparsa con manopola di bloccaggio
- 2 maniglie di trasporto
- Cerniere di ottima qualità
- Cinghie interne di fissaggio bagaglio
- Ampia tasca frontale

## AIR FORCE



## AIR FORCE

Art. 9003045N

€ tbc  
2 / 2 / 24

✂ 38 x 73 x 43 cm

✓ 120 l

◆ 420D Polyester/PVC

📏 4,5 kg



**Spazioso borsone da viaggio con ruote che soddisfa tutte le aspettative del viaggiatore sportivo.**

**CARATTERISTICHE:**

- Tessuto esterno idrorepellente
- 2 scomparti principali molto spaziosi
- Struttura stabile e robusta
- Comparto superiore con accesso diretto e tasca laterale
- Pratiche maniglie per il trasporto
- Maniglione telescopico a scomparsa con manopola di bloccaggio
- Cinghie interne di fissaggio bagaglio
- Tasca a rete interna
- Cinghie di compressione esterne
- Ruote angolari di alta qualità
- Cerniere di prima scelta



## ATREA

Art. 0712090N

€ tbc  
5 / 20 / -

✂ 7,4 x 4 x H22,3 cm

📏 160 g

Comoda bilancia portatile pesa bombole o bagagli, con metro a nastro incorporato. Da portare sempre con sé in viaggio per essere più sicuri del peso trasportato evitando quindi spiacevoli sorprese. Pesa fino a 34 kg. Piccola, leggera e robusta.



## EXPLORE DUFFLE

Art. 9003047N

€ tbc

2 / 10 / 60

Ø 40 x 68 cm

85 l

Tarpaulin 100% PVC

1,8 kg



Borsa viaggio impermeabile in Tarpaulin resistente all'acqua e allo sporco.



## COM-PACK TRAVELBAG

Art. 9003055N.C03

€ tbc

5 / 50 / -

29 x 56 x 24 cm

28 x 18 cm

35 l

Nylon Ripstop

300 g



Borsa multiuso completa di maniglie e cinghia a tracolla.



## MONEY BELT

Art. 9004031N.C01

€ tbc

5 / 50 / -

31 x 14 cm

150 g

600D Polyester 100% Polyester

Due tasche esterne cernierate. Cintura regolabile. Dorso in tessuto morbido e piacevole al tatto.

## SOS NG

Art. 0428060N

€ tbc

12 / 144 / -

210 x 135 cm

43 g

Coperta di emergenza in alluminio.



## RAINMAN

Art. 8410011N

€ tbc

9 / 9 / -

203 x 127 cm

200 g

100% PVC

Poncho impermeabile. Colori assortiti: blu, verde.







## SHUTBAGS

Art. 0202204N

€ tbc  
12 / 72 / -

100% PVC

PACK 3X

Protezione ermetica da acqua e polvere per oggetti di valore. Con cordoncino per il trasporto.  
1x 12,5 x 17,5 cm  
1x 17,5 x 25 cm  
1x 26,5 x 34 cm

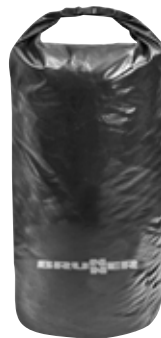
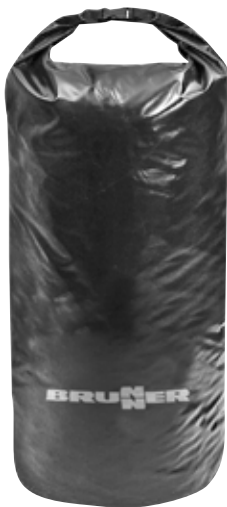

## DRYZAK



M.O.

Master



DRYZAK M	Art. 0202229N	36 l	Polyester / PVC	€ tbc	5	20	-
DRYZAK L	Art. 0202230N	62 l	Polyester / PVC	€ tbc	5	20	-



Sacca impermeabile con cuciture saldate e pratica chiusura ad arrotolamento con fibbia.



## POOL ROUND

Art. 0812010N

€ tbc  
16L  
4 / 20 / -

V 16l

Ø 33 x 25 cm

400 g

100% PVC



## POOL

Art. 0812011N

€ tbc  
12L  
6 / 24 / -

V 12l

29 x 29 x 16 cm

280 g

Polyester / PVC



Lavello pieghevole con bordo rinforzato.

Secchio rotondo pieghevole con bordi rinforzati e pratico organizer ad aggancio.



# BEAUTY CASE

COLLECTION



## BODY&SOUL

Art. 9004015N.C73

€ tbc  
5 / 30 / -

25,5 x 12 x 48,5 cm

25,5 x 12 x 15 cm

350 g

PVC / Polyester

Pratico necessaire da viaggio realizzato in resistente tessuto a doppia spalmatura.



## HOLIDAY

Art. 9004016N.C73

€ tbc  
5 / 30 / -

26 x 14 x 37 cm

25 x 13 x 28 cm

415 g

PVC / Polyester

Il beauty-case imbottito offre ampio spazio per una lunga vacanza.



## WASH BAG

Art. 9004018N.C73

€ tbc  
5 / 30 / -

25,5 x 44 cm

25,5 x 16 cm

210 g

PVC / Polyester

Beauty-case con specchietto interno. Gancio in metallo. Vari scomparti e tasche con cerniere interni. Chiusura a fibbia.



## WC-MASK

Art. 0402031N

€ tbc  
20 / 160 / -



Copripesile igienico per WC in carta dissolvibile. Confezione da 20 pezzi.



Bio degradable  
dissolvable in water





256 Fori pollice



## TROPICANA

Art. 0202087N

€ tbc  
8 / 16 / -

Ø 60 x 900 x H250 cm

600 g

100% PES



Zanzariera da viaggio con ventaglio di tensione e custodia. Adatta per letti doppi.

## POP UP SINGLE

Art. 0202089N

€ tbc  
6 / 6 / -

Ø 50 x 900 x H250 cm

385 g

100% PES

Zanzariera da viaggio con anello di tensione pieghevole (sistema POP UP ad apertura automatica).

## POP UP DOUBLE

Art. 0202090N

€ tbc  
6 / 6 / -

Ø 50 x 1500 x H250 cm

720 g

100% PES



## CITRONELLA CANDLE S

Art. 0205055N

€ tbc  
12 / 48 / -

Ø 6,5 x H6 cm

12 g

**Candela alla citronella avvolta in elegante contenitore di melamina.**

### CARATTERISTICHE:

- Contiene olio di citronella

## CITRONELLA CANDLE M

Art. 0205056N

€ tbc  
12 / 48 / -

Ø 10 x H8,5 cm

18 g

## TEA LIGHT

Art. 0205061C

€ tbc  
20 / 60 / -

PACK 15X

ESSENCE Citronella

Candele per lampade outdoor alla citronella.

## MOSSY BOX

Art. 0205011C

€ tbc  
12 / 60 / -

PACK 1X

Art. 0205011N

€ tbc  
20 / 20 / -

PACK -

Ø 130 x H50 mm

100 g

Contenitore per zampironi in materiale plastico termoresistente. Spirali escluse.



# OUTDOOR FURNITURE



**SEDIE E LETTINI  
TAVOLI  
ARMADI E MOBILETTI CUCINA**



# CHAIR COLLECTION

## FOLDING OUTDOOR CHAIRS

La nostra gamma di sedie comprende una varietà di modelli che hanno funzioni diverse a seconda delle dimensioni, del peso, delle dimensioni dell'imballaggio o del comfort. Quando si sceglie una sedia da tavolo, si dovrebbe prevedere uno schienale verticale, mentre una sedia Outdoor pura deve essere leggera con una piccola dimensione di imballaggio. D'altra parte, una sedia relax deve avere una seduta più ampia e uno schienale comodamente reclinabile. Per facilitare la scelta della sedia giusta, abbiamo elaborato una panoramica che mostra tutte le caratteristiche importanti dei modelli di sedie Brunner ed il loro uso ideale.

# SKYE RT

BLACK

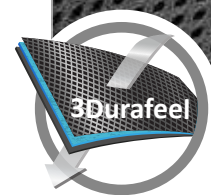



C09

## SKYE RT

Art. 0404060N.C09

€ tbc  
2 / 2 / 16

 43 x 46 x H46/112 cm

 108 x 60 x 10 cm

 4,5 kg





OPTIONAL

## SKYE RT STANDALONE FOOTREST

Art. 0404066N.C09

€ tbc  
6 / 6 / 36

 61 x 49 x H49 cm

 67 x 60 x 8 cm

 2,1 kg

Poggiapiedi autoportante a 4 gambe con copertura 3D traspirante con telaio in alluminio verniciato a polvere.

**Sedia Camping pieghevole di alta qualità dotata di uno schienale alto regolabile a 8 posizioni ed una classica struttura ad U che garantisce un appoggio sicuro anche su pavimenti morbidi. Il telaio compatto e pieghevole è realizzato in tubolare di alluminio verniciato a polvere che, in combinazione con la resistente seduta in tessuto 3D, garantisce una seduta stabile e assai confortevole.**

### CARATTERISTICHE:

- Telaio pieghevole in alluminio verniciato a polvere
- Seduta in tessuto 3Durafeel
- Schienale regolabile a 8 posizioni con poggiatesta integrato
- Eleganti braccioli in plastica resistente
- Elevato comfort di seduta
- Confezione molto compatta
- Poggiagambe fornibile come optional

**C09**

# SKYE

**BLACK**

## SKYE 3D

Art. 0404063N.C09

€ tbc  
2 / 2 / 16

47 x 41 x H47/122 cm

60,5 x 106,5 x 12 cm

4,3 kg

**Sedia da esterno pieghevole a 4 gambe con schienale reclinabile a 6 posizioni.****CARATTERISTICHE:**

- Telaio in alluminio
- Tessuto 3D imbottito
- Schienale regolabile a 6 posizioni
- Braccioli in robusto materiale plastico
- Possibilità di collegare un poggiatesta
- Compatta e facile da trasportare quando ripiegata

## SKYE 3D COMPACT

Art. 0404088N.C09

€ tbc  
4 / 4 / 16

65 x 57 x H40/95 cm

58 x 85 x 9 cm

3,3 kg

**Sedia pieghevole salvaspazio in alluminio con schienale fisso e struttura ad U. Schienale basso. Rivestimento in confortevole tessuto 3D.**

## SKYE ARIA

Art. 0404069N.C09

€ tbc  
2 / 2 / 16

69 x 62 x H109 cm

93 x 62 x 14 cm

6,6 kg

**Sedia pieghevole per esterni con struttura in alluminio superleggera. Schienale e seduta sono realizzati in materiale termoplastico resistente alle intemperie. Il design ben studiato e innovativo con telo amovibile di serie, rende questa sedia un accessorio elegante e confortevole sia per interni che per esterni.**

## OPTIONAL

## SKYE 3D FOOTREST

Art. 0404064N.C09

€ tbc  
6 / 6 / 54

47 x 72 x H51/43 cm

47 x 72 x 6 cm

1 kg

**Poggiatesta pieghevole per sedia Skye 3D.****CARATTERISTICHE:**

- Struttura in alluminio
- Telo portante in tessuto 3D
- Compatto e comodo da trasportare quando ripiegato



## Thermoplastic





# SKYE

DARK GREY & LIGHT GREY

C67

C53



NOT AVAILABLE  
IN SOME  
EU COUNTRIES

## SKYE

Art. 0404063N

€ tbc  
2 / 2 / 16

46,5 x 42 x H48/124 cm

108 x 60 x 11 cm

4,5 kg

**Sedia pieghevole a 4 gambe con schienale reclinabile a 6 posizioni.**

### CARATTERISTICHE:

- Struttura in alluminio
- Telo portante in Syntex Plus
- Schienale reclinabile a 6 posizioni
- Braccioli in resistente materiale plastico
- Possibilità di collegare un poggiatesta
- Compatta e comoda da trasportare quando ripiegata



6 Positions

## SWAN SKYE

Art. 0404067N.C67

€ tbc  
1 / 1 / 12

90 x 69 x 113 cm

98 x 16 x 69 cm

7,5 kg

**La sedia Swan Skye è la miglior prova che il campeggio può essere davvero confortevole. Essendo un vero e proprio prodotto outdoor la sua seduta permette di scegliere qualsiasi posizione rilassata si desidera.**

### CARATTERISTICHE GENERALI:

- Telaio in acciaio verniciato a polvere
- Telo portante in Syntex Plus
- Aperta e pronta all'uso in pochissimi secondi
- Facile da trasportare e compatta



## OPTIONAL

### SKYE FOOTREST

Art. 0404064N

€ tbc  
6 / 6 / 54

47 x 72 x H51/43 cm

47 x 72 x 6 cm

1 kg

**Poggiatesta pieghevole.**

### CARATTERISTICHE:

- Struttura in alluminio
- Telo portante in Syntex Plus
- Compatto e comodo da trasportare quando ripiegato





# CHAIR 4 ALL ERGONOMIC CONCEPT

## DI QUALI DIMENSIONI DI SEDIA AVETE BISOGNO?

Sei seduto comodamente? La dimensione della sedia riveste sempre un ruolo importante!

Molti di noi passano molte ore in posizione seduta durante il giorno. Al lavoro, a casa, a tavola o mentre ci rilassiamo: dovremmo fare attenzione a star seduti comodamente, per evitare tensioni e per aumentare il nostro benessere.

Fondamentalmente, non si può formulare uno statement generale sulla giusta posizione di seduta. La taglia del corpo, le proporzioni del corpo e anche l'altezza del tavolo giocano un ruolo importante.

Ci sono quindi molte ragioni che ci fanno riflettere sulla giusta dimensione di una sedia. Non solo il comfort, la meccanica e il design attraente della vostra sedia Outdoor, ma anche una postura ergonomica dovrebbero essere un importante criterio di selezione.

Grazie alle nuove taglie sviluppate, la collezione di sedie Aravel / Rebel Pro certamente dispone della sedia giusta per la vostra taglia. Molto importante: la giusta altezza della seduta influisce positivamente sul benessere!

Fate attenzione che i vostri piedi siano comodamente appoggiati al pavimento e che gli avambracci formino un angolo retto con la parte superiore del braccio. Quindi la sedia giusta non solo deve piacere, ma deve anche essere davvero la scelta giusta per te e per le tue misure corporee.

**Extra  
Comfort**

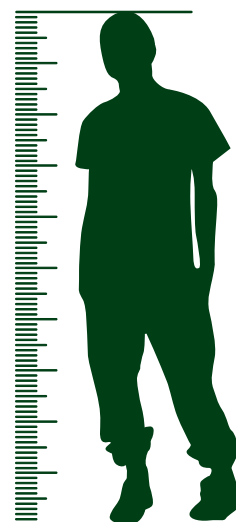
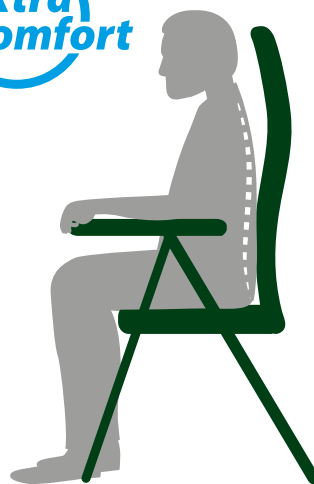

originaldesign

## INFO

### 3DURAFEEL PRO

REBEL / ARAVEL / STRAAL

Il tessuto di rivestimento 3Durafeel Pro è un tessuto molto speciale utilizzato nelle nostre collezioni di sedie Rebel, Aravel e Straal. Grazie alla sua permeabilità all'aria e alla delicatezza sulla pelle, trasforma il comfort in una meravigliosa esperienza di seduta per ore di relax all'aperto. 3Durafeel Pro si asciuga incredibilmente in fretta anche dopo una leggera pioggia e irradia una piacevole atmosfera di benessere sulla veranda, sulla terrazza o sul balcone. E questo in modo affidabile per molti anni.

Infatti, 3Durafeel Pro è resistente allo strappo e all'abrasione, traspirante, resistente alla luce e repellente allo sporco. Costruzione monostrato (trama speciale).

### 3DURAFEEL

ARAVEL / SKYE

Il tessuto di rivestimento 3Durafeel è un tessuto molto speciale utilizzato nelle nostre collezioni di sedie Aravel e Skye. Grazie alla sua permeabilità all'aria e alla delicatezza sulla pelle, trasforma il comfort in una meravigliosa esperienza di seduta per ore di relax all'aperto. 3Durafeel si asciuga incredibilmente in fretta anche dopo una leggera pioggia e irradia una piacevole atmosfera di benessere sulla veranda, sulla terrazza o sul balcone. E questo in modo affidabile per molti anni. Infatti, 3Durafeel è resistente allo strappo e all'abrasione, traspirante, resistente alla luce e repellente allo sporco. Costruzione a tre strati.





# ARAVEL VITACHIC

ANTRACITE

C69

3Durafeel  
Pro

150kg

100%  
Polyester

alu

WARRANTY  
3  
YEARS  
BRUNNER



## ARAVEL VITACHIC S

Art. 0404065N.C69S

€ tbc  
2/2/16

41 x 44 x 46,5/116 cm

106,5 x 59,5 x 10 cm

5,2 kg

## ARAVEL VITACHIC M

Art. 0404065N.C69M

€ tbc  
2/2/16

47 x 44 x 48/121 cm

114 x 64,5 x 10 cm

5,3 kg

## ARAVEL VITACHIC L

Art. 0404065N.C69L

€ tbc  
2/2/16

49 x 44 x 50/126 cm

117,5 x 67,5 x 10 cm

5,58 kg

La sedia pieghevole Aravel Vitachic è realizzata con uno schienale alto regolabile (7 posizioni) e con la nostra speciale imbottitura 3Durafeel Pro che offre un massimo di comfort durante tutte le stagioni. Dotata di un telaio ultraleggero pieghevole in alluminio che ne consente un rapido e semplice processo di apertura e ripiegamento. Disponibile nelle versioni S-M-L.

80kg



100kg



OPTIONAL

## ARAVEL VITACHIC STANDALONE

Art. 0404073N.C69

€ tbc  
6/6/84

61 x 49 x H49 cm

67 x 60 x 8 cm

2,1 kg

## ARAVEL VITACHIC STOOL

Art. 0404078N.C69

€ tbc  
6/6/84

27 x 40 x H45 cm

42 x 60 x 4 cm

1,2 kg

Sgabello pieghevole con struttura in alluminio e seduta realizzata in tessuto speciale 3Durafeel PRO.

Poggiapiedi indipendente con struttura pieghevole in alluminio verniciato a polvere e rivestimento in tessuto 3Durafeel Pro di alta qualità. Utilizzabile anche come sgabello.



7 Positions

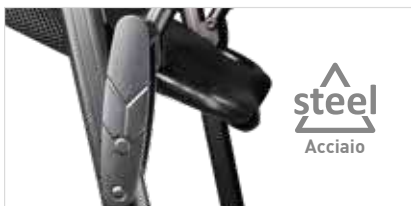

steel  
Acciaio

**C09****3Durafeel**

# ARAVEL

**BLACK**

# S M L

**Moderna sedia pieghevole a 4 gambe con schienale reclinabile a 7 posizioni.****CARATTERISTICHE:**

- Struttura in profilo di alluminio ad alta portata
- Telo portante in tessuto 3D imbottito e traspirante
- Schienale ergonomico e reclinabile a 7 posizioni
- Schienale con poggiatesta imbottito integrato
- Braccioli in resistente materiale plastico
- Snodo centrale in acciaio
- Possibilità di collegare un poggiatesta
- Compatta e comoda da trasportare quando ripiegata

**ARAVEL 3D S**

Art. 0404065N.C09S

€ tbc  
2 / 2 / 16

41 x 44 x H46,5/116 cm

106,5 x 59,5 x 10 cm

5,2 kg

**ARAVEL 3D M**

Art. 0404065N.C09M

€ tbc  
2 / 2 / 16

47 x 44 x H48/121 cm

114 x 64,5 x 10 cm

5,3 kg

**ARAVEL 3D L**

Art. 0404065N.C09L

€ tbc  
2 / 2 / 16

49 x 44 x H50/126 cm

117,5 x 67,5 x 10 cm

5,58 kg

**ARAVEL 3D STOOL**

Art. 0404084N.C09

€ tbc  
6 / 6 / 84

27 x 40 x H45 cm

42 x 60 x 4 cm

1,2 kg

**Sgabello pieghevole Aravel 3D.****CARATTERISTICHE:**

- Struttura in alluminio
- Telo portante in tessuto 3D imbottito e traspirante.
- Compatto e comodo da trasportare quando ripiegato



# ARAVEL

## BLACK

C09



### OPTIONAL

#### ARAVEL UNIVERSAL FOOTREST

Art. 0404079N.C09

€ tbc  
6 / 6 / 36

43 x 95 x H47/44 cm

43 x 95 x 7 cm

1,1 kg



**Poggiagambe pieghevole universale per sedie Aravel 3D (S-M-L).**

##### CARATTERISTICHE:

- Struttura in alluminio
- Telo portante in tessuto 3D imbottito e traspirante
- Compatto e comodo da trasportare quando ripiegato

#### ARAVEL 3D FOOTREST

Art. 0404099N.C09

€ tbc  
6 / 6 / 54

51 x 71 x H48/43 cm

51 x 71 x 6 cm

1,35 kg



**Poggiagambe pieghevole per sedia Aravel 3D M.**

##### CARATTERISTICHE:

- Struttura in alluminio
- Telo portante in tessuto 3D imbottito e traspirante
- Compatto e comodo da trasportare quando ripiegato

#### ARAVEL 3D STANDALONE FOOTREST

Art. 0404073N.C09

€ tbc  
6 / 6 / 36

61 x 49 x H49 cm

67 x 60 x 8 cm

2,1 kg



Poggiapiedi autoportante a 4 gambe con copertura FULL-3D traspirante con telaio in alluminio verniciato a polvere.

#### ADAPTER SET LIMBO ARAVEL

Art. 0404070N.C09

€ tbc  
10 / 40 / -
**MOUNTING SYSTEM  
ARAVEL L**

**MOUNTING SYSTEM  
ARAVEL S**

#### FRESHBACK

Art. 0404005N.C06

€ tbc  
12 / 24 / -

400 g

100% Microfibre Polyester



Adattatore universale per poggiagambe Limbo. Permette un facile fissaggio a tutte le varianti della collezione di sedie Aravel. Set da 2 pezzi.

Comodo e pratico rivestimento in spugna per le collezioni di sedie Aravel e Rebel. Colore: grigio. Taglio perfettamente aderente. Misura: M.



C09

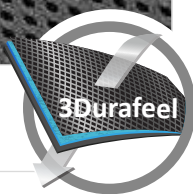

# ARAVEL

BLACK

NEW  
2023



## ARAVEL DIRECTOR

Art. 0404080N.C09

€ tbc

2 / 2 / -

42 x 33,5 x 45/82 cm

75 x 52 x 10 cm

3,9 kg

Sedia da regista con telaio classico realizzato mediante profilo in alluminio verniciato a polvere. Ingombro ridotto grazie allo schienale ribaltabile. Seduta in tessuto 3Durafeel imbottito e traspirante. Braccioli imbottiti e rivestiti. Molto compatta e facile da riporre quando chiusa.

### CARATTERISTICHE:

- Telaio salvaspazio in profilo di alluminio 22 x 22 mm
- Costruzione molto robusta
- Rivestimento realizzato in tessuto di poliestere 3Durafeel
- Schienale pieghevole per ridurre al minimo le dimensioni della confezione
- Braccioli imbottiti
- Elevato comfort di seduta
- Dimensioni di stivaggio ridotte



## ARAVEL VANCHAIR

Art. 0404077N.C09

€ tbc

2 / 2 / -

48 x 37 x H41,5/82 cm

58,5 x 73,5 x 9,5 cm

3,8 kg

Sedia pieghevole super compatta con resistente telaio pieghevole in alluminio, appositamente realizzata per minibus e van. Snodo centrale in metallo. Rivestimento imbottito realizzato in comodo tessuto 3Durafeel per un alto livello di comfort.

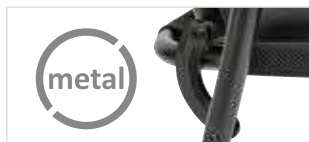

## ARAVEL DYNAFOLD

Art. 0404068N.C09

€ tbc

4 / 4 / -

51,5 x 46 x H47,5/110 cm

95 x 31 x 18 cm

6 kg

Pratica sedia pieghevole con schienale alto ad inclinazione regolabile, barre laterali e comodi braccioli per un elevato comfort abbinato a dimensioni di trasporto molto compatte. Il resistente tessuto in poliestere ed i piedini antisprofondamento anteriori completano la grande funzionalità della sedia. Con sacca di trasporto.





# ARAVEL

## BLACK

C09

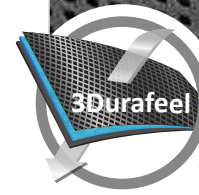

### SWAN 3D

Art. 0404071N.C09

€ tbc

1 / 1 / 15

50 x 49 x H48/116 cm

95 x 74 x 13,5 cm

8,0 kg

**Poltrona Relax che meglio offre un grado di comfort di altissimo livello. Costruzione stabile e robusta con struttura pieghevole in alluminio. Braccioli larghi e confortevoli.**

#### CARATTERISTICHE:

- Schienale regolabile senza scatti con leva di bloccaggio
- Aperta e pronta all'uso in pochissimi secondi
- Non necessita di premontaggio
- Facile da trasportare

NOT AVAILABLE  
IN SOME  
EU COUNTRIES



### ARAVEL HIGH DUNA 3D

Art. 0410062N.C09

€ tbc

1 / 1 / 8

198 x 64 x H48/103 cm

84 x 12 x 72 cm

8 kg

Letto di alta qualità con struttura in alluminio verniciato a polvere e pratico tettuccio parasole. Grazie alla sua ampia e alta superficie, salire e scendere è eccezionalmente facile e senza alcuna difficoltà. Inoltre, la superficie di sdraio rivestita in tessuto 3D imbottito offre un elevato grado di comfort. Il poggiatesta è regolabile a 5-posizioni. Dopo l'uso, il letto può essere facilmente ripiegato, trasportato e riposto per risparmiare spazio.



**ADJUSTABLE**  
Ø 70-85mm



## OPTIONAL

### CANCAGE

Art. 0404023N

€ tbc

1 / 10 / -

15 x 22 x 7,5 cm

180 g

Il portabevande Cancage garantisce un supporto sicuro a lattine e bottiglie su moltissime sedie Outdoor, da campeggio e da giardino. Il sistema di montaggio rapido con regolazione angolare permette un posizionamento individuale del portabevande.

### PADDY

Art. 0404074N.C06

100% Polyester

Comodo cuscino coprisedia imbottito. Adatto per sedie pieghevoli a schienale alto.

### MESA

Art. 0404098N

€ tbc

6 / 6 / 140

27 x 23 x H4 cm

400 g

Grande ripiano laterale per bevande e accessori in robusto materiale plastico.

**C07**

# ARAVEL

## GREY

Moderna sedia pieghevole a 4 gambe con schienale reclinabile a 7 posizioni.

**CARATTERISTICHE:**

- Struttura in profilo di alluminio ad alta portata
- Telo portante in tessuto 3D imbottito e traspirante
- Schienale ergonomico e reclinabile a 7 posizioni
- Schienale con poggiatesta imbottito integrato
- Braccioli in resistente materiale plastico
- Snodo centrale in acciaio
- Possibilità di collegare un poggiamambe
- Compatta e comoda da trasportare quando ripiegata



### OPTIONAL

## ARAVEL 3D M

Art. 0404065N.C07M

€ tbc  
2 / 2 / 16

47 x 44 x H48/121 cm

114 x 64,5 x 10 cm

5,3 kg

### Eating Position

### Lounger

### 7 Positions

### Relax

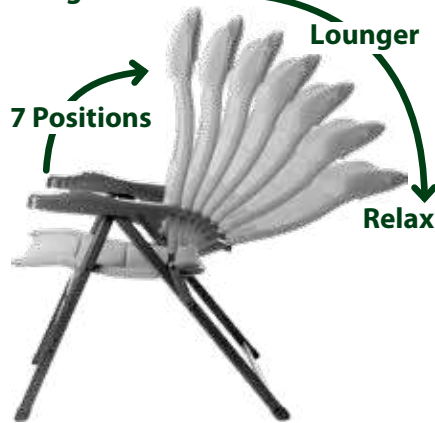
**10 cm  
Space Saver**

## ARAVEL 3D STANDALONE FOOTREST

Art. 0404073N.C07

€ tbc  
6 / 6 / 36

61 x 49 x H49 cm

67 x 60 x 8 cm

2,1 kg

Poggiamambe autoportante a 4 gambe con copertura FULL-3D traspirante con telaio in alluminio verniciato a polvere.

## ARAVEL 3D FOOTREST

Art. 0404099N.C07

€ tbc  
6 / 6 / 54

51 x 71 x H48/43 cm

51 x 71 x 6 cm

1,35 kg

Poggiamambe pieghevole per sedia Aravel 3D M.

**CARATTERISTICHE:**

- Struttura in alluminio
- Telo portante in tessuto 3D imbottito e traspirante
- Compatto e comodo da trasportare quando ripiegato

## ARAVEL 3D STOOL

Art. 0404084N.C07

€ tbc  
6 / 6 / 84

27 x 40 x H45 cm

42 x 60 x 4 cm

1,2 kg



Sgabello pieghevole Aravel 3D.

**CARATTERISTICHE:**

- Struttura in alluminio
- Telo portante in tessuto 3D imbottito e traspirante.
- Compatto e comodo da trasportare quando ripiegato



# ARAVEL

## DARK GREY & LIGHT GREY

Moderna sedia pieghevole a 4 gambe con schienale reclinabile a 7 posizioni.

### CARATTERISTICHE:

- Struttura in profilo di alluminio ad alta portata
- Telo portante in Syntex Plus
- Schienale ergonomico e reclinabile a 7 posizioni
- Schienale con poggiatesta imbottito integrato
- Braccioli in resistente materiale plastico
- Snodo centrale in materiale plastico
- Possibilità di collegare un poggiamambe
- Compatta e comoda da trasportare quando ripiegata

Syntex  
Plus

C67

C53

alu

120kg





### OPTIONAL

## ARAVEL SYNTEX

Art. 0404065N

€ tbc  
2 / 2 / 20

 47 x 45 x H50/120 cm

 112 x 65 x 9 cm

 5 kg

## ARAVEL FOOTREST

Art. 0404083N

€ tbc  
6 / 6 / 60

**Poggiamambe pieghevole.**

### CARATTERISTICHE:

- Struttura in alluminio
- Telo portante in Syntex Plus
- Compatto e comodo da trasportare quando ripiegato

 48 x 60/75 cm

 48 x 75 x 6 cm

 1 kg

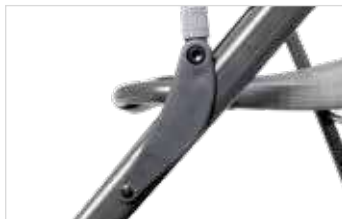

## INFO

Syntex  
Plus

Le sedute in Syntex Plus si contraddistinguono per la loro popolarità ed il loro successo veramente duraturo. Si presentano con una elegante superficie strutturata (30% poliestere - 70% PVC) dal fascino visibile, ma discreto. L'alto livello di comfort ed una piacevole sensazione di freschezza sono solo due degli aspetti strettamente pratici che fanno della collezione nelle sue 2 varianti di colore una scelta perfetta per l'ambiente Outdoor.

 80kg



## ARAVEL STOOL SYNTEX

Art. 0404084N

€ tbc  
6 / 6 / 96

**Sgabello pieghevole Aravel.**

### CARATTERISTICHE:

- Struttura in alluminio
- Telo portante in Syntex Plus
- Compatto e comodo da trasportare quando ripiegato

 27 x 40 x H45 cm

 42 x 60 x 4 cm

 1 kg



# OUTDOOR LIFESTYLE



# REBEL

C69

C51



# S M L



## REBEL SMALL

Art. 0404002N

€ tbc  
2 / 2 / 14

46 x 44 x H46/117,5 cm

110 x 60 x 12 cm

5,5 kg



## REBEL MEDIUM

Art. 0404002N

€ tbc  
2 / 2 / 14

48 x 46 x H48,5/123 cm

114 x 65 x 12 cm

6,1 kg



## REBEL LARGE

Art. 0404002N

€ tbc  
2 / 2 / 14

54 x 45 x H51,5/125 cm

117 x 71 x 12 cm

6,5 kg



## REBEL UNIVERSAL FOOTREST

Art. 0404003N

€ tbc  
6 / 6 / 36

95 x H43 cm

95 x H10 cm

1,80 kg



## OPTIONAL

## REBEL STANDALONE FOOTREST

Art. 0404004N

€ tbc  
6 / 6 / 36

61 x 49 x H49 cm

65 x 61 x 8 cm

2,1 kg

## INFO

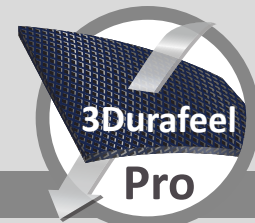

Il tessuto di rivestimento 3Durafeel Pro è un tessuto molto speciale utilizzato nelle nostre collezioni di sedie Rebel. Grazie alla sua permeabilità all'aria e alla delicatezza sulla pelle, trasforma il comfort in una meravigliosa esperienza di seduta per ore di relax all'aperto. 3Durafeel Pro si asciuga incredibilmente in fretta anche dopo una leggera pioggia e irradia una piacevole atmosfera di benessere sulla veranda, sulla terrazza o sul balcone. E questo in modo affidabile per molti anni. Infatti, 3Durafeel Pro è resistente allo strappo e all'abrasione, traspirante, resistente alla luce e repellente allo sporco. Costruzione monostrato (trama speciale).

Poggiagambe universale per la collezione di sedie Rebel nelle 3 varianti di misura S-M-L. Attacco a clip sulla traversa rotonda.

Poggiapiedi autoportante a 4 gambe con copertura FULL-3D traspirante con telaio in alluminio verniciato a polvere.

**C69**

# STRAAL

## BLACK



### STRAAL M

Art. 0404007N.C69M

€ tbc  
2 / 2 / 16

49 x 42,5 x H48/120 cm

112 x 48 x 12 cm

5,7 kg

**Bellissima sedia da campeggio pieghevole di nuova concezione con un design unico ed una qualità eccellente. Il telaio pieghevole salvaspazio in alluminio occupa pochissimo spazio quando ripiegato e l'esclusiva copertura 3Durafeel Pro garantisce una seduta comoda e traspirante.**

#### CARATTERISTICHE:

- Design moderno
- Telaio e snodo centrale in alluminio
- Rivestimento in tessuto 3Durafeel Pro
- Schienale ergonomico
- Schienale regolabile a 7 posizioni
- Poggiatesta integrato
- Braccioli sagomati con ampia superficie di contatto
- Elevato comfort di seduta
- Poggiatesta disponibile come optional

### OPTIONAL

### STRAAL FOOTREST

**Poggiatesta per sedia pieghevole Straal M. Fissaggio facile e veloce alla traversa stabilizzatrice posta sotto alla seduta della sedia. Il poggiatesta trasforma la sedia pieghevole Straal in una comoda poltrona relax.**

#### CARATTERISTICHE:

- Design moderno
- Telaio pieghevole in alluminio
- Rivestimento in tessuto 3Durafeel Pro

Art. 0404008N.C69

€ tbc  
2 / 2 / 36

48 x 75 x H36/48

48 x 75 x 6 cm

1,7 kg



### STRAAL STOOL

Art. 0404009N.C69

€ tbc  
2 / 2 / 84

42 x 48 x H42 cm

60 x 44 x 9 cm

1,6 kg

**Sgabello pieghevole della linea Straal. Realizzato in alluminio, compatto e comodo da trasportare e riporre.**

#### CARATTERISTICHE:

- Design moderno
- Telaio pieghevole in alluminio
- Rivestimento in tessuto 3Durafeel Pro





# PHANTOM

BLACK



C58



Eating Position

Lounger

Relax

7 Positions

Extra  
Comfort



OPTIONAL

## PHANTOM FOOTREST

Art. 0404059N.C58

€ tbc  
6 / 6 / 36

- 52 x 62,5 x H80,5 cm
- 47 x 69 x 6 cm
- 1,2 kg

Poggiapiedi pieghevole per sedia Phantom.

## PHANTOM STOOL

Art. 0404053N.C58

€ tbc  
6 / 6 / 96

- 27 x 40 x H45 cm
- 42 x 60 x 4 cm
- 1,1 kg

Robusto sgabello pieghevole con seduta in tessuto Licotex resistente alle intemperie. Telaio salvaspazio in tubo tondo di alluminio.



8 cm



## PHANTOM

Art. 0404058N.C58

€ tbc  
2 / 2 / 16

- 48 x 38 x H48/121 cm
- 65,5 x 8 x H112 cm
- 5,2 kg

**Sedia pieghevole ultrapiatta con schienale reclinabile.**

### CARATTERISTICHE:

- Struttura in profilato ovale di alluminio
- Schienale reclinabile a 7 posizioni
- Ultrapiatta quando ripiegata
- Materiali di alta qualità
- Braccioli molto confortevoli
- Design moderno



## ORBIT CHAIR L

Art. 0404010N.C20

€ tbc  
6 / 6 / -

45 x 31 x H37/69 cm

33 x Ø 11 cm

1 kg



Sedia Outdoor con innovativa struttura pieghevole che permette di ottenere delle dimensioni molto compatte e perfette per il trasporto. La combinazione ideale di comfort, peso leggero e montaggio semplice. Un vero e proprio must-have per backpackers, bikers, campers e in generale per qualsiasi attività all'aria aperta. Completa di pratica sacca custodia.



## DIR-ACTION DEMTEX

Art. 0404033N.C06

€ tbc  
4 / 4 / 56

54 x 44 x H44/82,5 cm

84 x Ø 15 cm

3,4 kg



Sedia regista Outdoor con telaio pieghevole. Braccioli imbottiti. Molto compatta quando ripiegata. Completa di sacca per il trasporto.

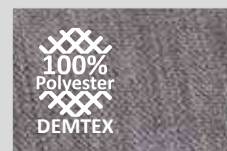

# IKARO ULTRALIGHT

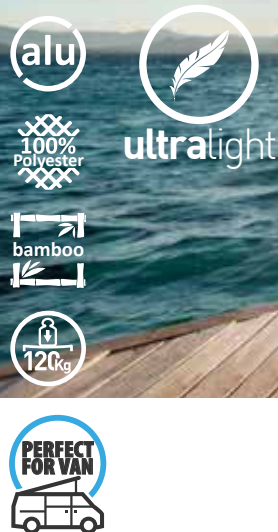

## IKARO ULTRALIGHT BEACH

## IKARO ULTRALIGHT

						M.O.	Master	
IKARO ULTRALIGHT BEACH	Art. 0404120N	53 x 48 x H27/61 cm	56 x 52 x 9 cm	1,8 kg	€ tbc	4	4	-
IKARO ULTRALIGHT	Art. 0404119N	54 x 65 x H42/89 cm	52 x 92 x 9 cm	2,18 kg	€ tbc	4	4	32

Sedia pieghevole da esterno ultraleggera di dimensioni compatte quando ripiegata, peso ridotto ed eccellente trasportabilità. Con braccioli in legno elegantemente lavorati. Due tubi curvi sullo schienale e sul sedile possono essere utilizzati come maniglie per il trasporto.



# DIRECTOR CHAIR

## COLLECTION



### BRAVURA

Art. 0404190N

€ tbc  
4 / 4 / 24

60 x 47 x H46/83 cm

11 x 49 x H83 cm

2,3 kg



#### Security System

Sedia regista con struttura pieghevole in alluminio. Schienale e seduta sono in poliestere antiscivolo. Seduta, schienale e braccioli sono imbottiti. Con meccanismo di chiusura di sicurezza.



### CAPTAIN

Art. 0404184N

€ tbc  
4 / 4 / 32

48 x 46 x H45,5/81 cm

46 x 12 x H81 cm

2,8 kg



#### Security System

Sedia regista compatta con solida struttura in alluminio anodizzato.



### BRAVURA COMFORT

Art. 0404192N.C06

€ tbc  
2 / 2 / 32

60 x 47 x H46/83 cm

11 x 49 x H83 cm

2,94 kg



Sedia regista in alluminio altamente confortevole con struttura di sicurezza verniciata e pieghevole, braccioli imbottiti e due tipi di rivestimento:

- a) In tessuto Syntex resistente alle intemperie
- b) In poliestere sfoderabile ed imbottito



### ONE SHOT

Art. 0404164N.C20

€ tbc  
4 / 4 / 32

56 x 45,5 x H46/81 cm

48 x 13,5 x H81 cm

2,15 kg



Sedia regista con struttura in alluminio.



### DJANGO

Art. 0404198N

€ tbc  
4 / 4 / 40

49 x 45,5 x H42/81 cm

51 x 81 x H9 cm

3,2 kg



Sedia regista con telaio in acciaio verniciato a polvere e tela in poliestere. Sistema di chiusura di sicurezza.



#### Security System



# EQUIFRAME

HIGH STABILITY



## ACTION EQUIFRAME

Art. 0404035N

€ tbc  
6/6/-

50,5 x 57 x H46/77 cm

77 x 17 x H17 cm

2,75 kg

COLORS

Sedia pieghevole con speciale telaio brevettato che ne garantisce il non ribaltamento. Realizzata con telaio in acciaio verniciato e seduta in resistente tessuto di poliestere. Molto facile da aprire e chiudere. Completa di borsa per il trasporto. Disponibile in 3 colori.



## ARMCHAIR EQUIFRAME

Art. 0404038N

€ tbc  
6/6/-

85 x 60 x H46/91 cm

94 x 18 x H18 cm

3,35 kg

COLORS

Sedia pieghevole con ampi braccioli realizzata con speciale telaio brevettato che grazie alla sua conformazione ne impedisce il ribaltamento. Realizzata con struttura in acciaio verniciato e seduta in resistente tessuto di poliestere. Semplicissima da aprire e richiudere. Completa di sacca per il trasporto. Disponibile in 3 colori.

## INFO

Sedia pieghevole con speciale telaio brevettato che ne garantisce il non ribaltamento.







INCLUDED



## ACTION KIDS EQUIFRAME

Art. 0404193N

62,5 x 42 x H31/64,5 cm

66 x 16 x H16 cm

2,39 kg

COLORS

€ tbc  
6 / 6 / -

## ACTION BABY EQUIFRAME

Art. 0404191N.C73

49,5 x 67 x H58/94 cm

94 x 20 x H20 cm

4,7 kg

€ tbc  
1 / 1 / -

Sedia pieghevole per bambini con speciale telaio di sicurezza brevettato che grazie alla sua conformazione ne impedisce il ribaltamento. Realizzata con struttura autobloccante in acciaio verniciato e seduta in resistente tessuto di poliesteri. Semplicissima da aprire e richiudere. Completa di sacca per il trasporto. Disponibile in 3 colori vivaci ed attraenti.

**Seggiolone salvaspazio da viaggio adatto per bambini dai 6 mesi fino a 4 anni (oppure 15 kg). Realizzato con speciale struttura di sicurezza in acciaio che grazie alla sua conformazione evita il ribaltamento del seggiolone stesso. La pratica seduta imbottita è facilmente lavabile e dispone di imbracatura regolabile con fissaggio a 3 punti. Completo di pratico vassoio con portabibite integrato.**

### CARATTERISTICHE:

- Braccioli imbottiti con bloccaggio di sicurezza
- Costruito e collaudato seconda la normativa EN16120
- Facile e veloce da ripiegare
- Telaio salvaspazio
- Imbracatura di sicurezza
- Con ampio vassoio per mangiare e bere (49,5 x 29,5 x 3 cm)
- Completo di sacca custodia







# ACTION

## OUTDOOR LIFESTYLE



### ACTION SOFA

Art. 0404041N

€ tbc  
2 / 2 / 20

148 x 63 x H44/92 cm

23 x 18 x H106 cm

5,3 kg



Acciaio



COLORS

C03 C06

Divanetto con struttura pieghevole in metallo. Schienale in resistente tessuto imbottito.

### ACTION SOFA 3D

Art. 0404041N.C09

€ tbc  
2 / 2 / 20

148 x 63 x H44/92 cm

23 x 18 x H106 cm

5,2 kg



Acciaio



**Confortevole divano con struttura pieghevole in metallo.**

#### CARATTERISTICHE:

- Tessuto poliestere 600D a doppio strato con inserti 3D
- Confortevoli braccioli con portabevande
- Design unico
- Con borsa di trasporto





## ACTION SOFA RENDEZ-VOUS

Art. 0404047N.C03

€ tbc  
2 / 2 / 20

147 x 65 x H44/99 cm

31 x 20 x H101 cm

8,3 kg



Divano per 2 persone di nuova concezione, molto confortevole, con struttura pieghevole leggermente angolata. Ideale per rilassarsi nella zona soggiorno di tende o verande. Con area organizer centrale dotata di due tasche in tessuto a zanzariera. Sedile e schienale comodamente imbottiti. Apertura e chiusura in pochi secondi senza necessità di montaggio speciale. La fornitura comprende una borsa per il trasporto e lo stoccaggio.



## ACTION DELILAH NG

Art. 0404032N.C03

€ tbc  
4 / 4 / 24

55 x 75 x H43/80 cm

89 x 46 x H12 cm

3,76 kg



Poltrona pieghevole con struttura tubolare in alluminio. Telo in robusto poliestere imbottito e trapuntato. Design moderno e confortevole. Perfetta in abbinamento con l'Action Sofa Rendez-Vous. Completa di sacca custodia.

### CARATTERISTICHE:

- Schienale e seduta in tessuto imbottito e trapuntato
- Apertura e chiusura in pochi secondi
- Dimensioni compatte quando ripiegata
- Facile da trasportare

## ACTION VIVAVITA LOUNGER

Art. 0404036N

€ tbc  
2 / 2 / 32

74 x 43 x H56/99 cm

118 x Ø 26 cm

4,05 kg



Il Vivavita Lounger è una sedia pieghevole elegante e super confortevole, perfetta per outdoor, campeggio e giardino. Grazie al suo design semplice ma funzionale, si apre e si chiude senza sforzo in pochi secondi, senza bisogno di montaggio. Il telaio verniciato a polvere è dotato di una copertura in poliestere riccamente imbottita. Una borsa per il trasporto è inclusa nella fornitura.



## ACTION VIVAVITA RELAXER

Art. 0404030N

€ tbc  
2 / 2 / -

75 x 44 x H43/95 cm

119 x 15 x H10 cm

5,0 kg



La Action Vivavita Relaxer dispone di una struttura in alluminio verniciato a polvere, particolarmente leggera. Seduta molto morbida in poliestere. Facile da trasportare.

### CARATTERISTICHE:

- Design moderno ed elegante
- Elevato comfort di seduta
- Completa di sacca per il trasporto





# RAPTOR

## FOLDING CHAIR COLLECTION



## INFO

- Telaio in robusto acciaio verniciato
- Tessuto poliestere resistente alle intemperie
- Pieghevole e compatta
- Con porta bibite integrato (XL/Enduro/Compact)
- Con sacca custodia

### RAPTOR CLASSIC

Art. 0404040N

€ tbc  
4 / 4 / 40

51 x 44 x H48/90 cm

94 x Ø 16cm

4,6 kg



COLORS

Confortevole sedia pieghevole con sostegno laterale della seduta.





## RAPTOR HIGHBACK

Art. 0404016N

€ tbc  
4 / 4 / 24

51 x 44 x H48/110 cm

114 x ø 16 cm

6 kg



COLORS

Per offrire un comfort ancora maggiore pur mantenendo dimensioni di ingombro molto compatte, la Raptor, la nostra preferita di sempre tra le sedie pieghevoli, è stata dotata di uno schienale rialzato di circa 20 cm. L'uso di comodi braccioli in plastica robusta dà inoltre la sensazione di essere seduti su una classica sedia a 4 gambe. Tutte le altre caratteristiche di questa gamma di sedie sono state mantenute.

## RAPTOR COMPACK

Art. 0404055N

€ tbc  
4 / 4 / 32

61,5 x 60 x H46/90 cm

27 x 21 x H92 cm

4,8 kg



COLORS

La nuova sedia Raptor Compact si caratterizza per la sua nuova struttura pieghevole che ne garantisce il minimo ingombro una volta chiusa e riposta, senza che ciò precluda l'abituale livello di confort delle sedie della collezione Raptor. Realizzata con telaio in acciaio verniciato a polvere e telo portante in robusto tessuto di poliestere spalmato. Completa di sacca per il trasporto.



## RAPTOR DEMTEX

Art. 0404054N

€ tbc  
4 / 4 / 32

51 x 44 x H48/90 cm

94 x ø 16 cm

4,6 kg



COLORS

L'apprezzata sedia pieghevole Raptor realizzata in due colori di tendenza con l'innovativo tessuto Demtex, abbinato alla collaudata struttura in acciaio verniciato.



## CRUISER

Art. 0404039N

€ tbc  
4 / 4 / 40

51 x 44 x H48/90 cm

94 x ø 16 cm

4,6 kg



COLORS

Confortevole sedia pieghevole con sostegno laterale della seduta. Grande stabilità grazie alla struttura in tubo ovale verniciata a polvere ed alle larghe basi regolabili dei piedi. Telo in robusto tessuto poliestere.





# RAPTOR

## FOLDING CHAIR COLLECTION



### RAPTOR NG 2.0

Art. 0404014N.C03

51 x 44 x H48/90 cm

94 x Ø 16 cm

4,8 kg

**Sedia pieghevole molto confortevole con imbottitura 3D. Costruzione salvaspazio. Borsa da trasporto inclusa.**

Sono stati apportati i seguenti miglioramenti alla versione aggiornata 2.0:

- Bracciali di nuova concezione con elegante e confortevole terminale in plastica
- Le aree laterali del rivestimento dello schienale sono completamente imbottite con tessuto 3D

€ tbc  
4 / 4 / 24



### RAPTOR 3D

Art. 0404034N.C03

51 x 44 x H48/90 cm

94 x Ø 16 cm

4,6 kg

Comoda e moderna: questa versione della sedia Raptor è dotata di un tessuto traspirante e ad asciugatura rapida. Mediante l'utilizzo della collaudata struttura Raptor rimane invariata l'eccellente stabilità di questo modello di sedia pieghevole.

€ tbc  
4 / 4 / 32



### RAPTOR RECLINER

Art. 0404050N.C20

51 x 45 x H45/102 cm

96 x Ø 25 cm

6,34 kg

Sedia pieghevole con schienale reclinabile a 3 posizioni. Con piedini antiprofondamento. Molto confortevole.

€ tbc  
2 / 2 / 24



### RAPTOR FOOTREST 3D

Art. 0404018N.C03

€ tbc  
6 / 6 / 84

48 x 65 x H37 cm

65 x 18 x H11 cm

2,9 kg



Poggiagambe indipendente e autoportante con rivestimento in tessuto 3D. Ingombro ridotto grazie al pratico telaio pieghevole. Si adatta a tutte le sedie e poltroncine pieghevoli con rivestimento in tessuto 3D. Con sacca custodia.

### BUTTERFLY NG

Art. 0406048N.C20

€ tbc  
3 / 6 / -

50 x 50 x H45 cm

63,5 x Ø 17 cm

1,4 kg



Tavolo pieghevole Outdoor con speciale meccanismo di tensionamento per il ripiano del tavolo in tessuto. Con comoda sacca per il trasporto.







### RAPTOR ENDURO

Art. 0404025N.C20

€ tbc  
4 / 4 / 28

- 56 x 42 x H44/95 cm
- 110 x Ø 21 cm
- 5,25 kg



Sedia pieghevole realizzata con una struttura particolarmente robusta e stabile. Le dimensioni maggiorate garantiscono una seduta confortevole anche a persona di statura superiore alla media. Completa di pratica sacca per la custodia.

### RAPTOR XL

Art. 0404015N.C03

€ tbc  
4 / 4 / 24

- 65 x 63 x H110 cm
- 114 x Ø 22 cm
- 6 kg



La nuovissima sedia pieghevole Raptor XL è il plus ultra per persone di statura superiore alla media. Naturalmente possiede tutti i vantaggi ed i miglioramenti dell'apprezzata serie di sedie pieghevoli Raptor.

### RAPTOR SUSPENSION

Art. 0404024N.C20

€ tbc  
4 / 4 / 32

- 51 x 40 x H47/94 cm
- 110 x Ø 20 cm
- 4,95 kg



Comoda sedia pieghevole con schienale a sospensione elastica. Con borsa per il trasporto.

#### Lumbar support



### KADRE

Art. 0406041N

€ tbc  
5 / 5 / 50

- 40 x 35 x H29 cm
- 45 x 12 x H12 cm
- 1,20 kg



Tavolino di appoggio molto compatto con piano arrotolabile in alluminio verniciato. Telaio in acciaio pieghevole. Molteplici usi. Con borsa per il trasporto.



# SEDERSI SEMPRE ED OVUNQUE





## OUTDOOR COT

Art. 0410032N.C30

€ tbc  
2/2/38

 190 x 64/72 x H43 cm

 95 x 21 x H14 cm

 4,8 kg



Letto da campo con struttura pieghevole e smontabile in alluminio.

NEW  
2023





## OUTDOOR COT XL2

Art. 0410045N

€ tbc  
2/2/-

 210 x 80 x H50 cm

 103 x 20 x 12 cm

 6,5 kg



Letto da campo di ampie dimensioni. Telaio in alluminio anodizzato.





## OUTDOOR COT AUTOMATIC

Art. 0410044N

€ tbc  
2/2/20

 191 x 66 x H44 cm

 105 x 15 x H15 cm

 8,9 kg



Letto da campo robusto con struttura pieghevole appositamente progettata per essere aperta e ripiegata in un istante. Comoda tela in resistente tessuto di poliestere con poggiatesta integrato e imbottito. Di dimensioni compatte quando ripiegato. Con pratica borsa per il trasporto.







### NIRO

Art. 0404107N.C03

€ tbc  
6 / 12 / -

-  32 x 32 x H40 cm
-  58 x Ø 9 cm
-  450 g





Sgabello treppiede compatto. Borsa da trasporto inclusa.

### TRIOL

Art. 0404089N

€ tbc  
6 / 12 / -

-  31 x 34 x H42 cm
-  60 x Ø 9 cm
-  1,2 kg





Sgabello treppiede con struttura in tubo di acciaio verniciato.

### FJORD

Art. 0404051N

€ tbc  
6 / 12 / -

-  35 x 35 x H45 cm
-  61 x Ø 9 cm
-  500 g





Sgabello treppiede pieghevole con struttura in alluminio anodizzato Ø 19 mm.

### BIG FJORD

Art. 0404103N

€ tbc  
6 / 12 / -

-  35 x 35 x H65 cm
-  76 x Ø 10 cm
-  800 g





Sgabello treppiede pieghevole con struttura in alluminio anodizzato Ø 19 mm.

### ROTO

Art. 0404046N

€ tbc  
6 / 12 / 82

-  32 x 32 x H43 cm
-  60 x Ø 17,5 cm
-  1,4 kg





Sgabello treppiede con comoda seduta rotante a 360°.

### JOLLY

Art. 0404105N

€ tbc  
10 / 20 / -

-  38 x 20,5 x H34 cm
-  23,5 x 28 x 2 cm
-  950 g





Sgabello pieghevole con solido telaio in filo di acciaio verniciato Ø 6 mm.

### TWISTY SQUARE

Art. 0404116N

€ tbc  
3 / 6 / -

-  32 x 24 x H40 cm
-  32 x 45 x 5 cm
-  1,32 kg





Sgabello pieghevole di alta qualità con struttura in alluminio ed elegante seduta in bambù. Design robusto, affidabile ed elegante. Pronto all'uso in pochi secondi e molto comodo da trasportare quando non in uso a causa delle piccole dimensioni quando ripiegato. Utilizzo molto versatile. Con borsa custodia.

### TWISTY OVAL

Art. 0404117N

€ tbc  
3 / 6 / -

-  36 x 30 x H40 cm
-  36 x 45 x 5 cm
-  1,32 kg





# BEACH BED

## COLLECTION



### BAHIA

Art. 0410013N

€ tbc  
2 / 2 / 20

192 x 61,5 x H31,5 cm

66 x 62 x H12,5 cm

4,9 kg



COLORS



Letino da sole con tela in Syntex resistente alle intemperie e resistenti snodi metallici.



**BEST  
SELLER**



### MALIBU'

Art. 0410011N

€ tbc  
2 / 2 / 14

189 x 61 x H26 cm

79 x 61 x 16,5 cm

5,2 kg



COLORS



Letino da sole a tre gambe con pratico tettuccio parasole.



### DUNA GRAND SLIMVISION

Art. 0410060N.C54

€ tbc  
1 / 1 / 8

200 x 65 x H40 cm

85 x 65 x H21 cm

5,7 kg



Brandina da spiaggia a 3 gambe di grandi dimensioni.







## MARBELLA

Art. 0410012N

€ tbc  
2 / 2 / 12

192 x 67 x H30 cm

77 x 19 x H64,5 cm

6,4 kg



COLORS



Letto da sole di alta qualità con struttura quadrangolare, a tre piedi ripiegabili in alluminio anodizzato. Tettuccio parasole regolabile.



## MARBELLA HIGH

Art. 0410022N

€ tbc  
1 / 1 / 8

198 x 64 x H48 cm

84 x 12 x H72 cm

7,50 kg



COLORS



Letto da sole molto confortevole con struttura stabile e pieghevole a tre gambe in alluminio anodizzato, seduta molto alta (H=48 cm) realizzata in tessuto Syntex Plus resistente agli agenti atmosferici e schienale regolabile. La fornitura comprende un pratico tettuccio parasole.

## BETA

Art. 0406013N

€ tbc  
4 / 4 / -

30 x 30 x H55/76 cm

880 g

Praticissimo tavolino da spiaggia con piede regolabile e telescopico in acciaio verniciato.





# BULA

## BEACH CHAIRS

Accomodarsi e rilassarsi - grazie alla sua speciale costruzione la spiaggia Bula XL raggiunge livelli altissimi in termini di comodità e relax.

### CARATTERISTICHE:

- Seduta rialzata
- Alzarsi è più facile
- Seduta più larga
- Braccioli imbottiti
- Telaio pieghevole verniciato a polvere
- Piedini antiprofondamento
- Tessuto in resistente poliestere
- Con borsa per il trasporto



### BULA

Art. 0404148N

€ tbc

6 / 6 / 72

57 x 50 x H73,5 cm

68 x Ø 18 cm

3,1 kg



COLORS



### BULA XL

Art. 0404149N

€ tbc

4 / 4 / 24

61 x 74 x H87/31 cm

98 x Ø 18 cm

4,7 kg



COLORS





# CUBA

## BEACH CHAIRS



### CUBA

Art. 0404147N

€ tbc  
6 / 6 / 60

Spiaggina pieghevole dal design moderno e funzionale.

- 57 x 43 x H64 cm
- 78 x Ø 14 cm
- 3,1 kg

**steel** Acciaio

**100% Polyester**

**102kg**

**COLORS** C57 C85

### CUBA AIRBACK

Art. 0404135N.C57

€ tbc  
6 / 6 / 72

Spiaggina pieghevole con caratteristiche identiche al collaudato modello Cuba, ma con schienale realizzato in rete traspirante e idrorepellente.

- 57 x 43 x H64 cm
- 78 x Ø 14 cm
- 3,1 kg

**steel** Acciaio

**100% Polyester**

**102kg**



### SIREN

Art. 0404152N

€ tbc  
4 / 4 / 28

Sedia da spiaggia in alluminio con schienale reclinabile a 4 posizioni e cuscino per un maggior comfort. Leggera e facile da trasportare. Perfetta per rilassarsi e godersi il sole in piscina o in spiaggia.

- 64 x 63 x H28/82 cm
- 74 x 66 x H12 cm
- 3,6 kg

**CARATTERISTICHE:**

- Schienale reclinabile in posizione completamente orizzontale
- Con gamba di supporto schienale pieghevole
- Confortevoli braccioli

**alu**

**Syntex Plus**

**110kg**





## CARGO

Art. 0814003N

€ tbc  
1 / 1 / 22

111 x 55 x H65 cm

36 x 21 x H84 cm

12,9 kg



Carretto pieghevole con struttura in robusto acciaio verniciato a polvere.

**<M>**  
**mountless**  
the smart  
folding system



## CARGO CROSS

Art. 0814014N

€ tbc  
1 / 1 / 16

102 x 58 x H65 cm

40 x 25 x H84 cm

12,5 kg



Carretto fuoristrada con telaio in acciaio pieghevole e ruote XXL. Costruzione robusta. Non è necessario alcun montaggio.

# CARGO







### CARGO COMPACT

Art. 0814013N € tbc  
1 / 1 / 25



- 101 x 50 x H55 cm
- 33 x 20 x H73 cm
- 9 kg



Esecuzione come il modello Cargo, ma di dimensioni più compatte.



**<M>**  
**mountless**  
the smart  
folding system





NEW  
2023



## CARGO TRUCK

Art. 0814016N

€ tbc  
1 / 1 / -

138 x 55 x 92 cm

31 x 19 x 74 cm

11,8 kg

XXL



steel  
Acciaio

100% Polyester

100kg

Il nuovo Cargo Truck è un carretto multifunzionale realizzato in robusto acciaio verniciato a polvere, telaio pieghevole salvaspazio e ruote XXL adatte anche per terreni sterrati e/o sabbiosi. La speciale costruzione dotata di involucro in resistente poliestere spalmato prevede anche la possibilità di aprire la parete posteriore per facilitare le operazioni di carico e scarico oppure per trasportare oggetti fuori misura. Utilizzo semplice e veloce che non necessita di montaggio. Completo di sacca per il trasporto.

IMPROVED



## BEACH CART NG

Art. 0814001N.C57

€ tbc  
5 / 5 / 30

101 x 50 x H36 cm

101 x 36 x H6 cm

3,5 kg

steel  
Acciaio

100% Polyester

100kg

Carrello multi-funzione pieghevole realizzato in acciaio verniciato a polveri. Ruote extra-larghe ed estraibili.









## MINI ROLLY

Art. 0814007N

€ tbc  
10 / 10 / -

 93,4 x 24,5 x 35 cm

 43 x 24,5 x 12,5 cm

 950 g

 35 kg

Carrello da trasporto con struttura telescopica in acciaio pieghevole e raccordi in resistente materiale plastico. Ruote larghe.

**BEST  
SELLER**





## PICK UP

Art. 0814009N

€ tbc  
6 / 6 / 96

 32 x 28 x 87 cm

 32 x 10 x 48,5 cm

 1,9 kg

 30 kg

Pratico trolley pieghevole con grandi ruote che rendono possibile l'utilizzo anche su terreni sterrati. Esecuzione leggera e stabile con profilo in acciaio verniciato a polvere. Cinghie di fissaggio incluse.





## EASY

Art. 0814005N

€ tbc  
6 / 6 / 72

 46 x 35 x 99 cm

 16 x 35 x 56 cm

 3,3 kg

 90 kg

Carrello pieghevole con robusta struttura in acciaio.



## AXA

Art. 0814004N

€ tbc  
1 / 1 / 50

 50 x 45 x 98 cm

 50 x 72 x 6 cm

 4,4 kg

 90 kg

Carrello pieghevole in alluminio con apertura automatica del piano di appoggio. Elastici ferma carichi sono inclusi nella fornitura.



# TABLE COLLECTION

## SCEGLIAMO IL TAVOLO GIUSTO!

Un tavolo è in realtà non altro che un ripiano con quattro gambe: questo è il primo pensiero che viene in mente alla maggior parte delle persone prima di aver considerato seriamente l'acquisto di un tavolo outdoor.

Ma soprattutto, quando si parla di tavoli outdoor, un tavolo non è affatto un semplice tavolo. Numerose differenze sono da considerare: la funzione, il luogo di utilizzo, il sistema di montaggio e le dimensioni di trasporto.

Questo solleva automaticamente la domanda: quali tavoli Outdoor e Camping sono effettivamente disponibili sul mercato?

Tavoli da campeggio e da esterno classici con piano fisso o pieghevole

Tavoli da campeggio e da esterno ultraleggeri con piano fisso o pieghevole

Tavoli da campeggio e da esterno pieghevoli con vassoio arrotolabile

Trovate ora il tavolo più adatto alle vostre necessità consultando la nostra vasta gamma di modelli con diverse funzioni, sistemi di montaggio, dimensioni di trasporto, colori e forme. Considerate le regole di base spiegate qui sopra, le proprie esigenze speciali ed il proprio stile preferito, vi rimane soltanto di tenere conto dell'ambiente circostante e delle condizioni di spazio preesistenti.



# DINEMIC

## ALUMINIUM TABLE TOP



### DINEMIC 4

Art. 0406053N

€ tbc  
1/1/-

126 x 70 x 56/80-85 cm

68 x 64 x 11 cm

8,2 kg

**Il Dinemic 4 è un tavolo per Outdoor e Camping di alta qualità con speciale piano pieghevole realizzato mediante l'utilizzo di listelli in alluminio molto resistenti alle intemperie ed all'usura. La struttura in metallo verniciato a polvere è munita di gambe regolabili in altezza. Può essere riposto in modo molto compatto quando ripiegato ed è quindi ideale per minibus, furgoni e camper.**

#### CARATTERISTICHE:

- Piano del tavolo resistente alle intemperie, adatto per uso esterno
- Costruzione robusta in metallo
- Regolazione senza scatti delle gambe del tavolo
- Pieghevole centralmente
- Leggero e facile da trasportare e riporre
- Completo di telo di protezione



# ACCELERATE CLASSIC

ROLLABLE TABLE TOP



## ACCELERATE 4

Art. 0406091N

120 x 80 x H71 cm

124 x 18 x 18 cm

7,3 kg

€ tbc  
1 / 1 / 28

## ACCELERATE 6

Art. 0406092N

146,5 x 80 x H71 cm

151 x 20,5 x 19 cm

8,5 kg

€ tbc  
1 / 1 / 24

### LOCKING SYSTEM



### LEVEL SYSTEM



MAX  
2 cm

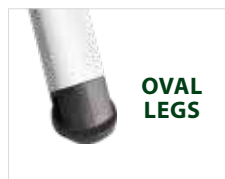

OVAL  
LEGS



La crescente popolarità del campeggio e del caravaning porta le comodità di tutti i giorni ad un livello completamente nuovo. Il tavolo Accelerate con ripiano arrotolabile è diventato uno dei tavoli da campeggio più leggeri, versatili e portatili sul mercato.

#### CARATTERISTICHE:

- Telaio in alluminio con tubo semiovale
- Ripiano arrotolabile con sistema Gapless
- Gambe pieghevoli
- Piedino regolabile
- Nuovo sistema di fissaggio del ripiano del tavolo
- Pratico ripiano in rete
- Borsa da trasporto inclusa



# ACCELERATE COMPACT 4

ROLLABLE TABLE TOP





## ACCELERATE COMPACT 4

Art. 0406093N

€ tbc  
1/1/-

 120 x 80 x H71 cm

 80 x 21 x 23,5 cm

 7,3 kg



L'Accelerate Compact 4 è l'ulteriore sviluppo del tavolo arrotolabile di successo Accelerate 4. Il design del telaio di nuova concezione consente di ridurre notevolmente le dimensioni del pacco, soddisfacendo così i requisiti di ingombro di minibus, van e camper furgonati.

### CARATTERISTICHE:

- Adatto per max. 4 persone
- Telaio in alluminio con sistema a innesto
- Regolazione livello
- Piano d'appoggio in alluminio senza interruzioni
- Confezione molto compatta
- Con pratico ripiano in rete
- Con borsa di trasporto

originaldesign



# TITANIUM AXIA

ROLLABLE TABLE TOP



## TITANIUM AXIA 2

Art. 0406097N

€ tbc  
1 / 1 / 32

104 x 62 x 72 cm

105 x 19 x 18 cm

5,5 kg

## TITANIUM AXIA 4

Art. 0406098N

€ tbc  
1 / 1 / 32

122 x 76 x H72 cm

122 x 18 x 17 cm

7,1 kg

## TITANIUM AXIA 6

Art. 0406099N

€ tbc  
1 / 1 / 20

147 x 76 x H72 cm

147 x 18 x 20 cm

8,2 kg

### LOCKING SYSTEM



### LEVEL SYSTEM



**SQUARE  
LEGS**

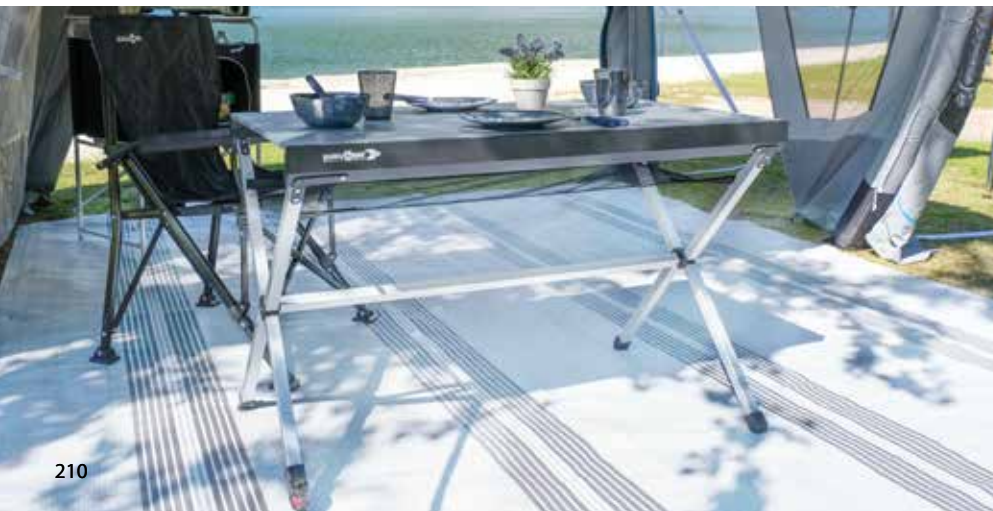

**Tavolo in alluminio brevettato con ripiano arrotolabile e speciale telaio pieghevole di facile montaggio.**

#### CARATTERISTICHE:

- Piano arrotolabile con listelli anodizzati color argento (sistema Gapless)
- Con livella a bolla integrata
- Telaio molto stabile realizzato con tubi quadrati in alluminio e barra stabilizzatrice centrale
- Piedino regolabile
- Con comoda rete e borsa da trasporto con due scomparti separati



# TITANIUM QUADRA TROPIC

## ROLLABLE TABLE TOP



### QUADRA TROPIC 4

Art. 0406095N

€ tbc  
1 / 1 / 25

120,5 x 70 x H72 cm

122 x 17,5 x 24,5 cm

7 kg

### QUADRA TROPIC 6

Art. 0406096N

€ tbc  
1 / 1 / 20

146 x 70 x H72,5 cm

149 x 32 x 14,5 cm

8,3 kg



La versione elegante del Titanium Quadra NG. Ripiano in alluminio con listelli terminali in vero legno di bambù e livella a bolla d'aria integrata per il perfetto funzionamento del nuovo sistema di livellamento 90° Adjustar. Con borsa da trasporto.



## INFO

Adjustar è un sistema di livellamento brevettato che permette una regolazione molto semplice dell'altezza delle gambe di appoggio mediante un nuovo metodo meccanico di trasmissione della spinta.

Grazie a questo meccanismo è possibile evitare che i mobili pendano in una direzione. Ogni camperista conosce questo problema e quanto sia laborioso e noioso regolare le gambe dei tavoli che devono essere spostati in alto, in basso e lateralmente, soprattutto quando ci si trova su terreni irregolari.

Ma Adjustar può essere utilizzato anche su terreni pianeggianti. Soprattutto se utilizzati negli spazi esterni, sui piani dei tavoli si formano piccole pozzanghere, che in combinazione con impurità come il polline, per fare un esempio, danno luogo a sgradevoli sbavature. Grazie al sistema Adjustar è possibile inclinare i tavoli per far defluire l'acqua.

## ADJUSTAR LEVELLING SYSTEM

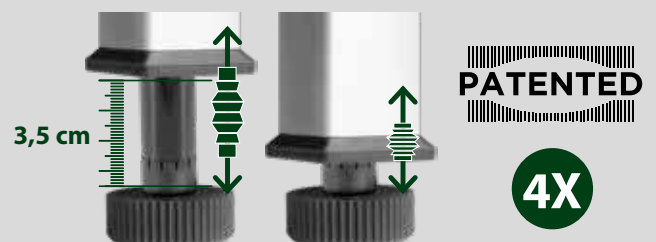



# TITANIUM QUADRA NG

ROLLABLE TABLE TOP



## TITANIUM QUADRA 4 NG

Art. 0406054N

120,5 x 70 x H72 cm

122 x 17,5 x 24,5 cm

6,3 kg

## TITANIUM QUADRA 6 NG

Art. 0406065N

146 x 70 x H72,5 cm

149 x 32 x 14,5 cm

7,5 kg

€ tbc  
1/1/25

€ tbc  
1/1/17

LEVEL SYSTEM  
PATENT PENDING

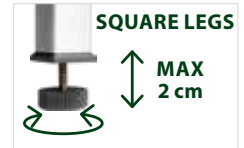
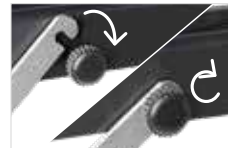

La nuova gamma di tavoli Quadra in alluminio con piano arrotolabile è caratterizzata da un nuovissimo telaio pieghevole, basato sulla classica costruzione del tavolo a 4 gambe verticali. Il piano del tavolo cosiddetto Gapless poiché senza intercapedini, è collegato al telaio del tavolo con uno speciale meccanismo di bloccaggio rapido. A differenza dei classici tavoli pieghevoli con telaio a X, il Quadra offre spazio sufficiente per le gambe su tutti e 4 i lati. Installazione facile e veloce. Design moderno combinato con una funzionalità migliorata. Una borsa custodia per il trasporto.



# TITANIUM QUADRA 4 COMPACT

ROLLABLE TABLE TOP





## TITANIUM QUADRA COMPACT 4

Art. 0406056N

€ tbc  
1/1/-

 120,5 x 70 x H72 cm

 85 x 22 x 23,5 cm

 6,3 kg



**Il tavolo rotabile Quadra Compact 4 si distingue per la struttura del telaio divisibile di nuova concezione, che consente di ridurre notevolmente le dimensioni dell'imballaggio e si adatta quindi alle particolari esigenze di spazio di minibus, van e camper furgonati. Rispetto al Quadra Classic, la stabilità, la funzionalità e l'aspetto rimangono invariati.**

### CARATTERISTICHE:

- Adatto per un massimo di 4 persone
- Telaio in alluminio con sistema a innesto
- Regolazione livello
- Piano del tavolo in alluminio senza fessure (Gapless)
- Confezione molto compatta
- Con sacchetto di imballaggio

originaldesign



# SILVER GAPLESS

## ROLLABLE TABLE TOP



### SILVER GAPLESS LEVEL 4

Art. 0406076N

€ tbc  
1 / 1 / 30

- 110 x 71 x H70 cm
- 107 x 18 x H20 cm
- 7,1 kg

#### LEVEL SYSTEM

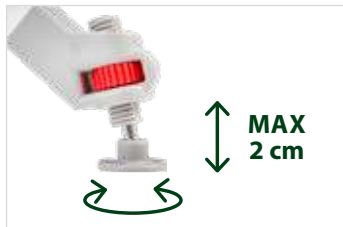

### SILVER GAPLESS LEVEL 6

Art. 0406077N

€ tbc  
1 / 1 / 25

- 140 x 81 x H70 cm
- 124 x 22 x H22 cm
- 9 kg



Tavolo pieghevole in alluminio con ripiano arrotolabile. Grazie alla speciale livella a bolla integrata, è possibile ottenere un posizionamento assolutamente orizzontale del ripiano su terreni irregolari (Level System). Struttura stabile con una gamba regolabile in altezza. È inclusa una borsa per il trasporto.



### HOGGY FIX

Art. 0406052N

€ tbc  
10 / 10 / -

- 40 x 40 cm
- 1,1 kg



### TOP FOR STOOL STOOL NOT INCLUDED



Piano per sgabelli con superficie laminata resistente ai graffi.



# LEVIN ULTRALIGHT

ROLLABLE TABLE TOP



ultralight



## LEVIN 2

Art. 0406085N

€ tbc  
1 / 1 / 50

80 x 60 x H70 cm

80 x 18 x 11 cm

3,2 kg

## LEVIN 4

Art. 0406086N

€ tbc  
1 / 1 / 40

110 x 67 x H70 cm

110 x 20 x 15 cm

4 kg

### LEVEL SYSTEM



LOCKING  
SYSTEM

Tavolo da esterno pieghevole con struttura in alluminio ultraleggero e ripiano arrotolabile. Costruzione completamente priva di materiali sintetici, senza snodi o connettori in plastica. Tutti i tubi che compongono il telaio sono dotati di elastici di solidarizzazione per evitare la perdita di singole parti. Il montaggio è rapido, molto semplice e non sono necessari attrezzi. Ottime dimensioni di imballaggio per un facile stoccaggio. Viene fornito con una pratica borsa per il trasporto.

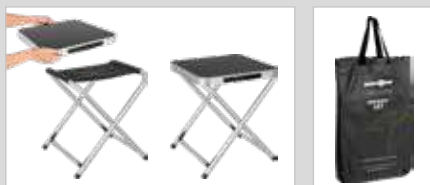

## HOGGY SET

Art. 0406051N.C03

€ tbc  
6 / 6 / 36



40 x 40 x H43 cm

55 x 40 x 7,4 cm

1,6 kg



Pratico set composto da un leggero sgabello pieghevole in alluminio con seduta in poliestere e robusto piano del tavolo. Viene fornito con borsa di trasporto.



# TORUN



Nuova serie di tavoli con ripiano in alluminio e gambe pieghevoli in acciaio verniciato. Compatti e facili da trasportare. L'impiego di materiali di alta qualità garantisce un utilizzo duraturo nel tempo.

## SPACE SAVER 5 cm



### TORUN 2

Art. 0406101N

€ tbc  
2 / 4 / 30

80 x 60 x H71 cm

80 x 60 x 5 cm

4,2 kg

### TORUN 4

Art. 0406102N

€ tbc  
2 / 4 / 24

110 x 61,5 x H71 cm

110 x 61,5 x 5 cm

5,1 kg

**<M>**  
**mountless**  
the smart  
folding system



### FLATPACK 4

Art. 0406105N

€ tbc  
1 / 1 / 26

120 x 60 x H70 cm

60 x 60 x 8 cm

6,5 kg

**Tavolo Outdoor di ottima qualità con ripiano pieghevole resistente alle intemperie e struttura leggera in alluminio anodizzato regolabile in altezza. Molto compatto quando ripiegato e quindi indicatissimo per minibus, van e camper furgonati.**

#### CARATTERISTICHE:

- Ripiano resistente alle intemperie, adatto per l'uso esterno
- Stabile struttura in profilo rettangolare di alluminio
- Regolabile in altezza senza scatti
- Ripiano pieghevole a metà
- Leggero e facile da trasportare quando ripiegato

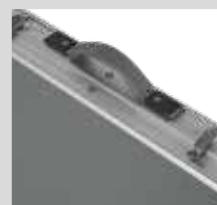



**<M>**  
**mountless**  
 the smart  
 folding system

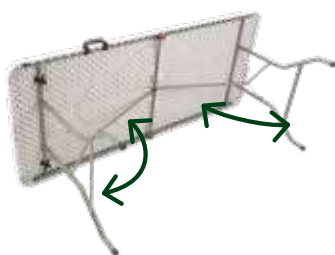

# CLUB

## BLOW-MOLDED TABLE TOP

### Tavolo pieghevole Club

#### CARATTERISTICHE:

- Sistema bloccagambe di sicurezza
- Gambe regolabili in altezza
- Molto piatti quando ripiegati - facile da riporre
- Ripiano in plastica PE soffiata
- Gambe tavolo in acciaio verniciato a polvere, effetto martellato
- Lunga durata



weatherproof





Acciaio

### CLUB 120

Art. 0406018N

€ tbc  
 1 / 1 / 22

 120 x 59 x H74 cm

 60 x 59 x H9 cm

 10 kg



### CLUB 150

Art. 0406010N

€ tbc  
 1 / 1 / 22

 152 x 71 x H74 cm

 76 x 71 x H9 cm

 12 kg





# CAMPERKING

## BAMBOO



### CAMPERKING S

Art. 0406089N

€ tbc  
1/1/30

80 x 60 x H49/58/70 cm

82,5 x 63 x 7 cm

7 kg

### CAMPERKING M

Art. 0406090N

€ tbc  
1/1/30

100 x 72 x H49/58/70 cm

102 x 39 x 10 cm

8,6 kg

**Tavolo Outdoor con struttura in metallo e ripiano in bambù.**

#### CARATTERISTICHE:

- Struttura pieghevole (sistema Mountless) in profilato di alluminio
- Ripiano in resistente bambù per esterni
- Piedino regolabile di livellamento
- Molto compatto e facile da riporre quando ripiegato
- Ottima stabilità
- Con pratica maniglia per il trasporto

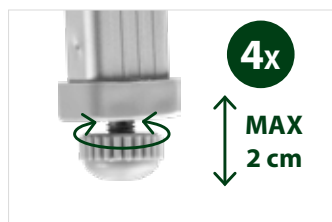



# CAMPERKING R

## BAMBOO



Tavolo rotondo per camping e outdoor con piano pieghevole a 4 elementi realizzato in elegante legno di bambù e struttura in alluminio regolabile in altezza. Dimensioni di ingombro molto compatte.



### CAMPERKING R

Art. 0406084N

€ tbc  
1 / 1 / 20

Ø 90 x H49/58/70 cm

90 x 10 x H25 cm

7,9 kg

### 4-fold table top

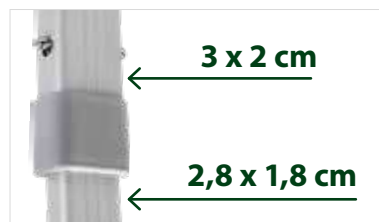
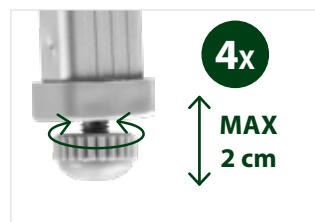
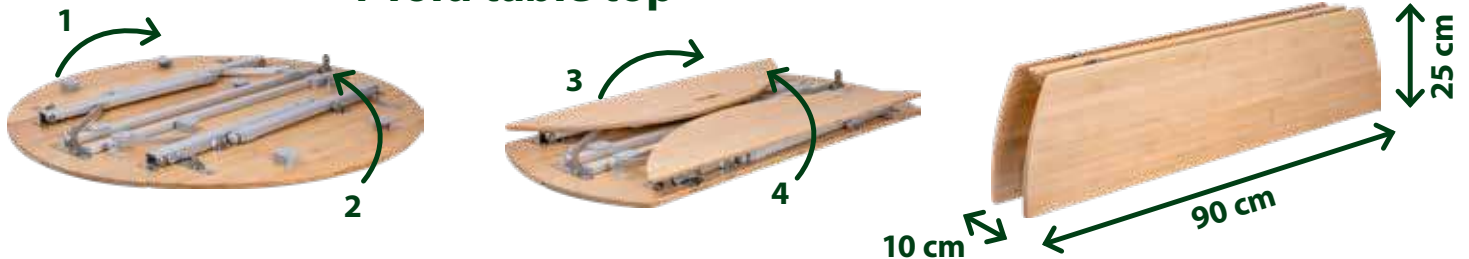





# LINEAR

## BLACK



**<M>**  
**mountless**  
the smart  
folding system



I modelli di tavolo della serie Linear sono dotati di ripiani di alta qualità resistenti alle intemperie ed al calore.

### CARATTERISTICHE:

- Altezza regolabile senza scatti
- Gambe tavolo telescopiche verniciate a polvere
- Ripiano di qualità resistente alle intemperie ed al calore (180°C)
- Facile da pulire



### LINEAR 80

Art. 0406037N.C69

€ tbc  
1 / 1 / 17

80 x 60 x H63/83 cm

80 x 60 x 7 cm

6,8 kg

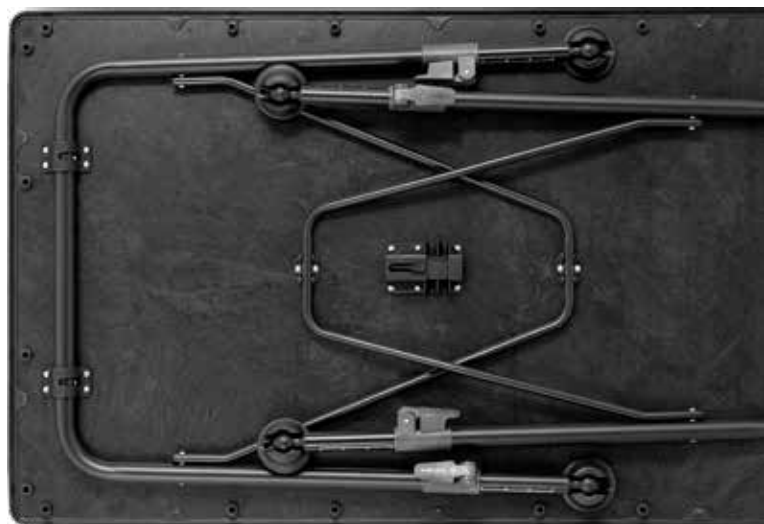

originaldesign





Bordo del tavolo in materiale plastico  
Ripiano resistente alle intemperie

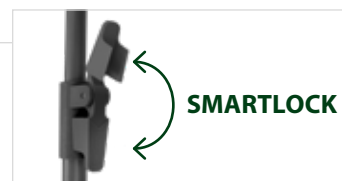

Gambe regolabili senza scatti



Piedino di livellamento con snodo



Dispositivo di bloccaggio gambe tavolo



## LINEAR 100

Art. 0406038N.C69

€ tbc  
1 / 1 / 12

🔒 100 x 68 x H63/83 cm

🔒 100 x 68 x 7 cm

📦 8,3 kg



## LINEAR 115

Art. 0406031N.C69

€ tbc  
1 / 1 / 14

🔒 115 x 70 x H63/83 cm

🔒 115 x 70 x 8 cm

📦 12,7 kg



## DRINKMASTER

Art. 0404061N.C9N

€ tbc  
12 / 24 / -

📏 20 x 18 cm

📦 226 g

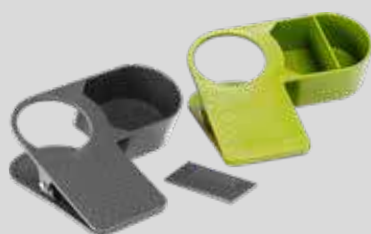

## DRINKMASTER S

Art. 0404029N.C9N

€ tbc  
20 / 80 / -

📏 20 x 10 cm

📦 170 g

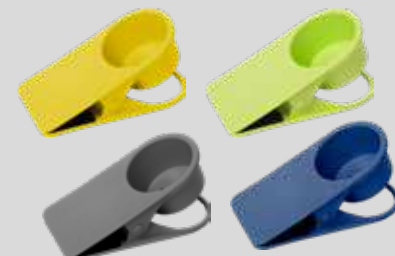

Drinkmaster - il portabevande intelligente per il campeggio, il camper, il caravan, la nautica ed il giardino. Viene agganciato lateralmente al tavolo e garantisce un appoggio sicuro a bicchieri, lattine e svariati piccoli accessori.

Pratico supporto portabevande realizzato in materiale plastico di ottima qualità. Costruito come un morsetto gigante, il Drinkmaster può essere fissato rapidamente a qualsiasi tavolo o a qualsiasi supporto piano. Le 2 pinze rivestite di materiale antiscivolo garantiscono un'ottima presa su quasi tutte le superfici.



# RECREO

## GREY



Il tavolo Recreo per Outdoor e Camping si distingue per la sua eccezionale stabilità e qualità e per il suo design innovativo ed elegante. Dotato di una speciale struttura in alluminio con guida centrale brevettata e di un solido ripiano Sevelit, conosciuto in tutto il mondo per la sua resistenza agli agenti atmosferici ed alle sollecitazioni meccaniche. L'utilizzo di raccordi e giunti in materiale plastico di alta qualità abbinato ad un processo di produzione professionale ha creato un modello di tavolo ideale per affrontare la vita all'aperto per molti anni. Disponibile in 2 misure.

### CARATTERISTICHE:

- Uso versatile, indoor/outdoor
- Alta resistenza ai raggi UV, alle intemperie ed al calore (pentole, sigarette)
- Ripiano Sevelit con bordo di protezione perimetrale
- Eccezionale resistenza ai graffi ed alle sollecitazioni meccaniche
- Facile da pulire
- Montaggio semplice e rapido
- Regolabile in altezza senza scatti

**<M>**  
**mountless**  
 the smart  
 folding system



## RECREO 80

Art. 0406110N

€ tbc  
1 / 1 / -

80 x 60 x H70 cm

80 x 60 x 7 cm

5,9 kg

## RECREO 100

Art. 0406111N

€ tbc  
1 / 1 / -

100 x 68 x H70 cm

100 x 68 x 7 cm

6,1 kg

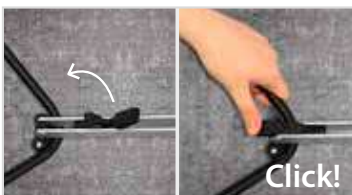
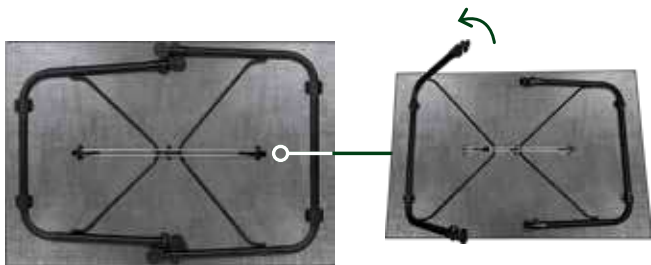

Click!

**PATENTED**



## STORACK 80

Art. 0406121N

€ tbc  
4 / 20 / -

80 x 60 x H13 cm

100% Polyester

## STORACK 100

Art. 0406122N

€ tbc  
4 / 20 / -

100 x 72 x H13 cm

100% Polyester

Pratico ripiano supplementare in rete per tavoli a 4 gambe verticali. Costruzione regolabile in lunghezza. Facilissimo da applicare mediante cinghiette munite di nastro Velcro. Completo di sacchetto custodia. Disponibile in 2 misure.



# TABYLO EXTERIO

## GRANITE

Tavolo da camping ed outdoor di alta qualità, dotato del nuovissimo ripiano superleggero Exteriolit della Severin. Massima stabilità grazie al telaio in alluminio brevettato ed abbinato al rivoluzionario sistema di livellamento Adjustar.



**<M>**  
mountless  
the smart  
folding system

**superlight**



protection film  
decorative layer  
core layers impregnated  
with phenolic resin

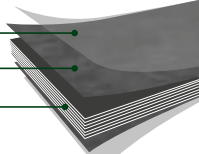

### TABYLO EXTERIO 100

Art. 0406020N

€ tbc  
1/1/14

🔒 100 x 68 x H50,5/75 cm

🔒 100 x 68 x 11 cm

🔒 7,40 kg

### TABYLO EXTERIO 120

Art. 0406021N

€ tbc  
1/1/14

🔒 120 x 68 x H50,5/75 cm

🔒 120 x 68 x 11 cm

🔒 8,90 kg

## INFO

p. 211

**ADJUSTAR**  
LEVELLING SYSTEM

**PATENTED**

**4X**

3,5 cm

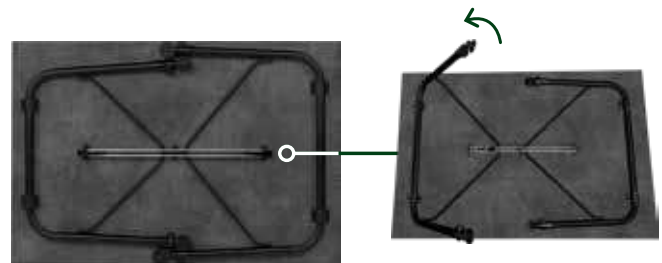
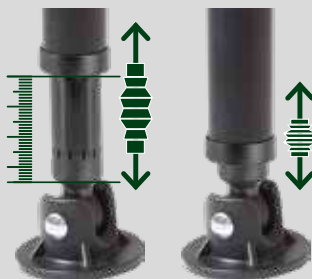

**PATENTED**



**alu** **30kg** **PATENTED** **ultralight**

# ELÙ

## BLACK MARBLE



### ELÙ 100

Art. 0406058N

€ tbc  
1 / 1 / 13

- 100 x 70 x H50,5/70 cm
- 100 x 70 x 11 cm
- 4,6 kg

### ELÙ 120

Art. 0406055N

€ tbc  
1 / 1 / 13

- 120 x 80 x H50,5/70 cm
- 120 x 80 x 11 cm
- 5,6 kg

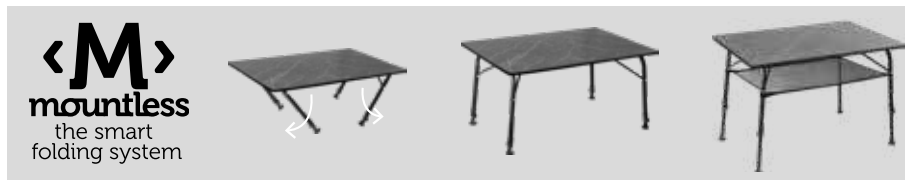
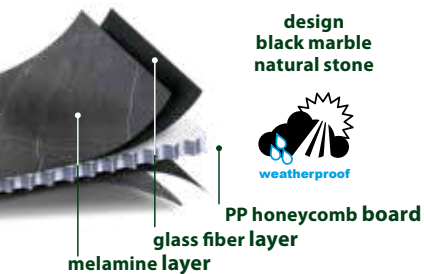

Tavolo da campeggio e da esterno di prima qualità con meccanismo di ripiegamento di nuova concezione e piano ultraleggero. Grazie ad un binario di scorrimento centrale, il robusto telaio del tavolo può essere montato e smontato in pochi secondi e senza difficoltà.

#### CARATTERISTICHE:

- Piano di lavoro: Costruzione ultraleggera, resistente alle intemperie e al calore
- Telaio: in alluminio con esclusivo meccanismo di chiusura
- Gambe del tavolo: alluminio anodizzato color nero ø 28/25 mm, regolabili in altezza senza scatti

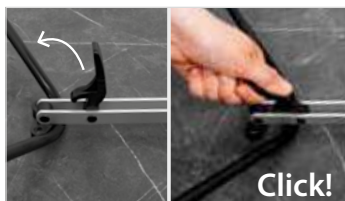



# ELÙ DUPLIT

## BLACK MARBLE



ultralight



LOCK-OPEN



1

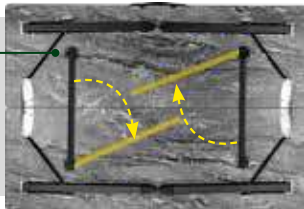

2

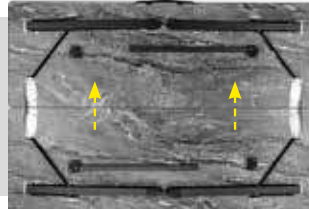

## ELÙ DUPLIT

Art. 0406050N

€ tbc

1 / 1 / 26

110 x 75 x H49/58/70 cm

110 x 37,5 x 9 cm

4,90 kg

Tavolo ultraleggero molto stabile con piano pieghevole centralmente e funzionale telaio in alluminio. La costruzione speciale permette alla struttura regolabile in altezza e poco ingombrante di essere ripiegata facilmente sul lato inferiore del tavolo ed aumenta anche lo spazio per le gambe su tutti e 4 i lati. Il piano del tavolo, multistrato e resistente alle intemperie, ha una speciale struttura a nido d'ape senza bordo di scorrimento tutto intorno per permettere all'acqua di defluire. Si piega e si ripone in modo molto compatto. Con maniglia per il trasporto.



3 x 2 cm

H 49/58/70 cm

2,8 x 1,8 cm



4x



MAX  
2 cm

Space Saver  
9 cm





# AZABACHE

## SQUARE



### AZABACHE CT SQUARE

Art. 0422085N.C03

85 x 52 x H90 cm

86 x 14 x 49 cm

9 kg

**Mobiletto cucina di nuova concezione con 2 scomparti multifunzionali separati. Piano di lavoro arrotolabile alto in alluminio.**

#### CARATTERISTICHE:

- Telaio quadrato di nuova concezione per una maggiore stabilità
- Gambe regolabili in altezza per adattarsi a terreni irregolari
- Rivestimento in poliestere resistente
- Zanzariera di aerazione nella parete posteriore
- Completo di paravento
- Con sacca custodia



€ tbc  
1/1/18



### AZABACHE CTW SQUARE HWT

Art. 0422086N.C03

110 x 48 x H90/118 cm

120 x 49 x 15 cm

11 kg

€ tbc  
1/1/15

**Pratica cucina da campeggio con lavello pieghevole integrato e rimovibile e 2 grandi vani portaoggetti con tanto spazio per il cibo e gli utensili da cucina. Con piano arrotolabile in alluminio di grandi dimensioni e gambe regolabili in altezza. Struttura estremamente stabile grazie all'impiego di profili rettangolari resistenti alla torsione. Montaggio semplice e veloce. Altezza di lavoro: 90 cm. La fornitura include un paravento ed un paraspruzzi, oltre ad una pratica borsa per il trasporto.**

#### CARATTERISTICHE:

- Struttura in alluminio
- Tessuto: 100% poliestere spalmato
- Scomparti: 2 vani portaoggetti separati con cerniera (5 ripiani)



### AZABACHE LS

Art. 0422081N.C03

€ tbc  
1/1/30



59 x 48 x H104 cm

42 x 11 x 53 cm

5,2 kg

Armadio funzionale in alluminio con ripiani interni.

### AZABACHE HS

Art. 0422082N.C03

€ tbc  
1/1/25



59 x 48 x H140 cm

42 x 11 x 69 cm

6,3 kg

Armadio funzionale in alluminio grande con ripiani interni.



# AZABACHE

## CROSS SQUARE



### AZABACHE CT CROSS SQUARE

Art. 0422088N.C03

€ tbc  
1/1/12

99 x 51 x H90/115 cm

102 x 13 x 59 cm

8,9 kg

Armadio multifunzionale di nuova concezione con struttura CROSS in tubolare di alluminio. 1 piedino regolabile in altezza, orientabili e di dimensioni tali da evitare l'affondamento in terreni morbidi. Dotato di 2 scomparti separati e ripiano di lavoro in alluminio resistente (sistema Gapless) con livella integrata.

#### CARATTERISTICHE:

- Telaio quadrato di nuova concezione per una maggiore stabilità
- Piano di lavoro alto
- Rivestimento in poliestere resistente
- Zanzariera di aerazione nella parete posteriore
- Completo di paravento
- Con sacca custodia



Grande armadio multifunzionale con 2 scomparti separati con cerniera e 6 ripiani interni. Lo scomparto più stretto può essere trasformato in armadio grazie ai ripiani divisibili e alla barra pensile integrata. Struttura molto robusta con telaio trasversale in alluminio e profili rettangolari resistenti alla torsione. Le pareti anteriori e posteriori possono essere ulteriormente stabilizzate tramite uno speciale dispositivo di tensionamento. I piedini di appoggio impediscono che l'armadio sprofondi in un terreno soffice o rovini il pavimento della tenda o la moquette. Il piedino regolabile in altezza consente una perfetta compensazione del livello su terreni irregolari. Una finestra in zanzariera nella parete posteriore fornisce la ventilazione interna all'armadio.

#### CARATTERISTICHE:

- Struttura: Alluminio
- Tessuto: 100% poliestere spalmato
- Con borsa



### AZABACHE LS CROSS SQUARE

Art. 0422089N.C03

€ tbc  
1/1/18

58 x 49 x H90 cm

62 x 12 x 61 cm

7,3 kg

Armadio multifunzionale di nuova concezione con struttura CROSS in tubolare di alluminio. 1 piedino regolabile in altezza, orientabili e di dimensioni tali da evitare l'affondamento in terreni morbidi. Dotato di grande scomparto e ripiano di lavoro in MDF rinforzato.

#### CARATTERISTICHE:

- Telaio quadrato di nuova concezione per una maggiore stabilità
- Rivestimento in poliestere resistente
- Zanzariera di aerazione nella parete posteriore
- Con sacca custodia



### AZABACHE HSC CROSS SQUARE

Art. 0422090N.C03

€ tbc  
1/1/12

70 x 59 x H125 cm

72 x 17 x 92 cm

8 kg



C06



# AZABACHE

DAILY

<M>  
mountless  
the smart  
folding system



## AZABACHE DAILY MP

Art. 0422083N.C06

€ tbc

1 / 1 / 20

60 x 51 x H84 cm

64 x 56 x 11 cm

6,3 kg

**Mobiletti box di alta qualità con robusto telaio pieghevole in profilato di alluminio.**

### CARATTERISTICHE:

- Zanzariera di aerazione nella parete posteriore
- Piedini regolabili in altezza
- Con maniglia per il trasporto
- Con sacca custodia



## AZABACHE DAILY CT

Art. 0422084N.C06

€ tbc

1 / 1 / 25

102 x 50,5 x H84 cm

105 x 53 x 9 cm

9,3 kg



## AZABACHE CUBE

Art. 0422091N.C06

€ tbc

1 / 1 / 16

65 x 45 x H58/81 cm

65 x 15 x H45 cm

9,7 kg



<M>  
mountless



**Cucinetto con classico tetto a falde.**

### CARATTERISTICHE:

- Finestre a zanzariera con copertura
- Balza perimetrale
- Con porta ingrandita e finestre supplementari entrata luce
- Completo di sacca custodia e accessori di montaggio





# MERCURY

## CROSS SQUARE

C06

**<M>**  
**mountless**  
 the smart  
 folding system



### MERCURY CROSS LS SQ

Art. 0422050N.C06

€ tbc

1 / 1 / 20

60 x 49 x H100 cm

62 x 11 x 61 cm

8,4 kg

Stabile armadietto multiuso con struttura CROSS realizzata in profilato rettangolare di alluminio e snodo centrale in metallo. Tutti i piedini sono regolabili in altezza. Con 3 ripiani interni ed un piano di lavoro in bambù. Sistema Mountless. Con custodia per il trasporto.



### MERCURY CROSS COOKER HWT SQ

Art. 0422054N.C06

€ tbc

1 / 1 / 15



92 x 49 x H90 cm

93,5 x 11 x H57 cm

10,9 kg

90 cm

**HIGH  
 WORKING  
 TOP**

Pratico mobiletto cucina con struttura CROSS realizzata in profilato rettangolare di alluminio e snodo centrale in metallo. Tutti i piedini sono regolabili in altezza. Con 2 ripiani interni ed un piano di lavoro in bambù. Sistema Mountless. Con paravento e custodia per il trasporto.



### MERCURY CROSS HS SQ

Art. 0422055N.C06

€ tbc

1 / 1 / 30

60 x 49 x H140 cm

76,5 x 11 x 63 cm

9,3 kg

Stabile armadietto multiuso con struttura CROSS realizzata in profilato rettangolare di alluminio e snodo centrale in metallo. Tutti i piedini sono regolabili in altezza. Con 4 ripiani interni ed un piano di lavoro in bambù. Sistema Mountless. Con custodia per il trasporto.



space saver

### LATIGA

Art. 0422098N

€ tbc

1 / 1 / 13

49 x 33 x H109 cm

49 x 9,5 x H109 cm

4,3 kg



**<M>**  
**mountless**

Riponitutto per camping e Outdoor con telaio pieghevole in alluminio e 3 cestini inclinabili di diverse dimensioni. Perfetto per mantenere in ordine la vostra tenda/veranda. Può essere ripiegato dopo l'uso per risparmiare spazio.





# RAZOR CT

## ULTRALIGHT



### RAZOR ULTRALIGHT CT

Art. 0422003N

€ tbc  
1 / 1 / -

80 x 46 x H82 cm

84 x 38,5 x 37,5 cm

5,9 kg



**Mobiletto cucina Outdoor ultraleggero con robusta struttura in alluminio ed elegante piastra di copertura in alluminio arrotolabile con listelli terminali in bambù. L'ampio armadio in tessuto diviso centralmente con 2 ripiani per ciascun scomparto e con rivestimento interno di colore chiaro, offre molto spazio per riporre cibi e stoviglie. Tutte e 4 le gambe sono regolabili in altezza. Montaggio e smontaggio semplici e intuitivi. Dimensioni molto compatte quando ripiegato.**

#### CARATTERISTICHE:

- Armadio in 100% poliestere con rivestimento interno di colore chiaro
- Gambe regolabili in altezza
- Comprende una pratica borsa per il trasporto



### WINWALL

Art. 0426011N

€ tbc  
5 / 10 / -

63,5 x 31 x H25,5 cm

63,5 x 31 x H1 cm

2,20 kg

Paravento per piano cottura con base resistente al calore. Tutti gli elementi sono pieghevoli e realizzati in metallo verniciato a polveri. Per fornelli a 2 e 3 fuochi.



### HANGAR 3

Art. 0420072N.C03

60 x 21 cm

100% Polyester

### HANGAR 2

Art. 0420073N.C03

40 x 21 cm

Pratica tasca portaoggetti con 2/3 tasche.

### HANGAR 6

Art. 0420071N.C03

90 x 30 cm

100% Polyester

Pratica tasca portaoggetti con 6 tasche ed un grande specchio.





# RAZOR LS

## ULTRALIGHT



### RAZOR ULTRALIGHT LS

Art. 0422004N

€ tbc  
1 / 1 / 40
 60 x 46 x H82 cm

 66 x 35 x 29 cm

 5,2 kg

**Armadio multifunzionale ultraleggero per Outdoor con robusto telaio ad innesto in alluminio. Montaggio e smontaggio semplici e intuitivi. Elegante piano di copertura in alluminio arrotolabile con listelli terminali in bambù. L'ampio pensile in tessuto con 4 ripiani e rivestimento interno chiaro offre un abbondante spazio di stivaggio per tutti i tipi di articoli necessari per la vita in camper. Tutte e 4 le gambe sono regolabili in altezza. Dimensioni compatte dell'imballaggio.**

#### CARATTERISTICHE:

- Armadio in 100% poliestere con rivestimento interno chiaro
- Gambe regolabili in altezza
- Include una pratica borsa per il trasporto



### HANKY

Art. 0424007N

€ tbc  
5 / 10 / -
 40,5 x 20 x H75 cm

 800 g

 100% PES

Armadietto pensile dotato di 3 mensole interne e 4 tasche esterne. Porta in zanzariera con apertura centrale a cerniera.

### HANGAR 12

Art. 0420070N.C03

€ tbc  
5 / 20 / -
 74 x 39 cm

 100% Polyester

Pratica tasca portaoggetti con 12 tasche.



### HANGAR 10S

Art. 0420075N.C06

€ tbc  
5 / 10 / -
 50 x 80 cm

 100% Polyester

Soluzione comoda ed elegante per riporre scarpe, sandali e altri oggetti. In totale sono disponibili 10 tasche copribili per l'organizzazione dello spazio di stivaggio del veicolo. Utilizzabile sia all'interno che all'esterno.







# DRIVE IN BLACK









## CHUCK BOX NG

Art. 0426079N.C03

€ tbc  
1 / 1 / 13
 90 x 50 x H82 cm

 92 x 51 x 13 cm

 6,5 kg

**Mobiletto cucina con struttura in alluminio molto resistente ed un grande piano di lavoro in MDF con bordatura perimetrale in alluminio. L'intero mobiletto trova posto nella borsa di trasporto inclusa. Facile da montare e smontare. L'ampio mobile con chiusura a cerniera offre spazio per riporre alimenti e accessori per la cucina. Include un supporto laterale pieghevole per un lavello collassabile.**

### CARATTERISTICHE:

- Telaio con gambe pieghevoli
- Pensile con base a griglia in acciaio
- Piedini regolabili in altezza
- Include un paravento ed un paraspruzzi in metallo



## OPTIONAL

CLEO  
FOLD-AWAY

not included



## DRIVE IN BLACK

Art. 0426032N.C03

€ tbc  
1 / 1 / 15
 100 x 50 x H78/128,5 cm

 100 x 50 x 14,5 cm

 11,9 kg



**Mobiletto cucina ideale per l'utilizzo Outdoor.**

### CARATTERISTICHE:

- Ripiano di lavoro in MDF con bordo in alluminio
- Gambe in profilo di acciaio
- Mobiletto pensile a 2 scomparti
- Lavello in plastica
- Robuste maniglie per il trasporto
- Sacca custodia

## KITCHENETTE

Art. 0422097N.C03

€ tbc  
1 / 1 / 15
 67 x 50 x H93,5 cm

 67 x 67,5 x 10,5 cm

 7,9 kg

Mobiletto cucina compatto e pieghevole con piano di lavoro resistente al calore, abbondante spazio di stivaggio, tasche laterali per gli utensili ed un pratico paravento/paraspruzzi in metallo. Ideale per tende e verande di caravan e minibus di dimensioni compatte. Con pratica borsa per il trasporto.





# SNACK BASIC



## SNACK BASIC

Art. 0422095N.C03

€ tbc  
1 / 1 / 12

62 x 46 x H90/109 cm

82 x 50 x 13 cm

5,5 kg



Fixing System



REMOVABLE



Mobiletto cucina da campeggio pieghevole con piano di lavoro arrotolabile, ripiano inferiore con armadio in tessuto rimovibile e utile paravento e paraspruzzi. Un piedino è regolabile in altezza. Veloce e facile da montare e smontare. Molto compatto quando chiuso e quindi facile da riporre. Completo di robusta borsa per il trasporto.

### CARATTERISTICHE:

- Telaio in metallo, verniciato a polvere
- Ripiano arrotolabile in alluminio
- Tessuto in 100% poliestere spalmato

## SNACK SQUARE

Art. 0422096N.C03

€ tbc  
1 / 1 / 11

120 x 52 x H90/109 cm

82 x 52 x 15 cm

8,2 kg



Mobiletto cucina di nuova concezione con struttura pieghevole extra stabile in profilo quadrato di alluminio. 2 armadi separati offrono ampio spazio per riporre cibo e utensili da cucina. La fornitura include un paravento ed un paraspruzzi, oltre ad una pratica borsa per il trasporto.

### CARATTERISTICHE:

- Ripiano arrotolabile: alluminio
- Armadi in 100% poliestere spalmato con porta a cerniera
- Altezza di lavoro: 90 cm (cucina standard)

## SNACK EASY BLACK

Art. 0426034N.C03

€ tbc  
1 / 1 / 16

141 x 50 x H80,5 cm

80 x 51 x 12 cm

7,8 kg



Combinazione molto pratica di cucina da campo e mobile portastoviglie.

### CARATTERISTICHE:

- Struttura in alluminio Ø 19/22 mm
- Ripiano laterale in MDF bordato in alluminio
- Mobiletto pensile in 100% poliestere con ripiani interni in MDF
- Facile da ripiegare
- Sacca di trasporto inclusa



MEPO BOX  
Ready

OPTIONAL





# TABLE AND KITCHEN



**STOVIGLIE OUTDOOR  
POPOTE**



# TABLEWARE

## COLLECTION

242

### STONEtouch®

ODETTE • TUSCANY • GRANADA • SAVANA • BELLAGIO  
• AMALFI • VENETIAN • PEARL • METEORE • AMADÈ

253

### PREMIUM CLASSIC

COTTERY • KASSANDRA • TIVOLI • GRANYTE  
• SANDHYA • SPACE • DOLOMIT • SPECTRUM

264

### SEVEN SEAS

BLUE OCEAN • NAUTICAL

267

### ALLROUND

SPHERICA • DEEP SEA • COSMIC • SERENADE • PRALIN

272

### SQUARE

KHADI • PANAREA • ENIGMA

274

### FLASH

SEQUOIA • BREEZE • ASTRALYS • BLUE BAY • TULIP • ESPRIT

278

### LIVING

BBGRILL • SOUP BOWL • PASTA & SALAD • PIZZA  
• CHEESE SET

280

### KIDS

ICE CREAM • JUNGLE PARADE • AROUND THE WORLD  
• BUTTERFLY • FARM • TIME TO TRAVEL • MOLLY • JACK  
• LET'S GO ADVENTURE

286

### GLASSWARE



# TABLETOP & ENTERTAINING

Gli articoli sono prodotti con la migliore melamina, composto ottenuto dalla combinazione di resine melaminiche e cellulosa che rende particolare questo materiale in quanto rigido e molto leggero.

BRUNNER MELAMINE:  
100% BPA-FREE



originaldesign



• Resistente al calore ed all'umidità

• Inodore ed insapore

• Facile da pulire

• Ottima resistenza agli urti

• Utilizzabile nel congelatore

• Lunga durata

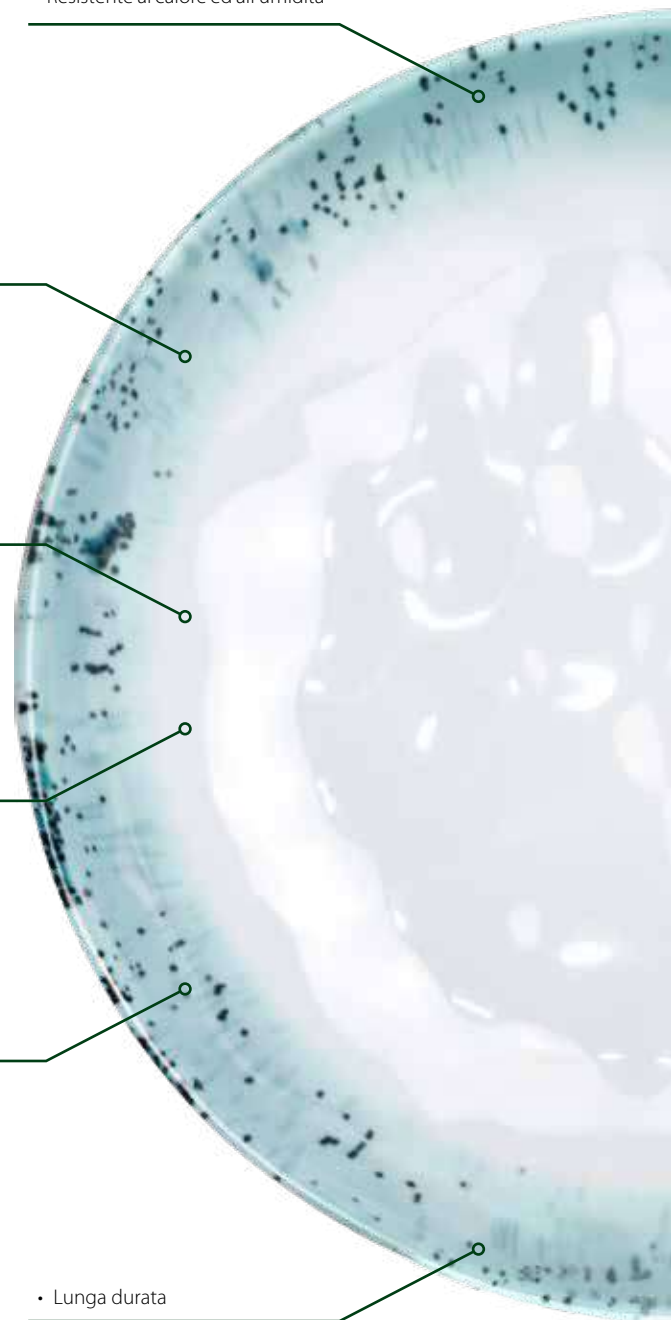



## INFO

## STONEtouch®

**Nuovo materiale ottenuto da una combinazione di melamina/polvere minerale con eccellenti proprietà funzionali:**

- Superficie dura
- Stabilità dimensionale
- Brilla come la porcellana
- Al tocco sembra porcellana
- Adatto per alimenti
- Igienico, facile da pulire
- Inodore e insapore
- Congelabile
- Lavabile in lavastoviglie
- Resistente alla rottura
- Lunga durata

**STONE**  
touch  
dinnerware

IMPROVED SURFACE



**BRUNER**

NOISE  
REDUCTION



# ANTISLIP

## NOISE REDUCTION

Mediante l'utilizzo di una guarnizione in gomma integrata nel fondo delle stoviglie viene data maggiore stabilità. Infatti vengono quasi azzerate le possibilità di scivolamento e caduta e inoltre viene notevolmente ridotto il fastidioso tintinnio nel caso di spostamenti.





# HOT MUG

**BPA free**

HEAT RESISTANT

**Resylin è un materiale termoplastico incolore su base ABS (acrilonitrile-butadiene-stirene), nel quale si fondono buone caratteristiche meccaniche ed una buona resistenza chimica.**

**VANTAGGI:**

- 100% senza BPA e adatto all'uso alimentare
- Ottime proprietà isolanti
- Riciclabile
- Resistente alla corrosione e abrasione
- Utilizzabile fino a 90°C (per breve tempo anche a 100°C)
- Ottima resistenza agli urti (anche a basse temperature)
- Utilizzabile nel congelatore





# SPACE SAVER

COMPACT STORAGE



# VIP STORAGE SYSTEM

SPACE ORGANIZING



**VIP**  
STORAGE  
**box**

COMES WITH  
ALL INCLUSIVE VIP  
STONETOUCH  
COLLECTION





**Piatto piano ø 26 cm**

Art. 0830025N.C3A

€ tbc  
12 / 24 / -



**Piatto fondo ø 21 cm**

Art. 0830026N.C3A

€ tbc  
12 / 36 / -



**Piatto dessert ø 19 cm**

Art. 0830027N.C3A

€ tbc  
12 / 48 / -



**Tazzina espresso**

Art. 0830048N.C3A

€ tbc  
6 / 48 / -



**Scodella ø 15 cm**

Art. 0830043N.C3A

€ tbc  
12 / 48 / -



**Insalatiera ø 26 cm**

Art. 0830030N.C3A

€ tbc  
4 / 16 / -



**Portauovo**

Art. 0830032N.C3A

€ tbc  
12 / 72 / -



# ODETTE

## STONEtouch®





### MIDDAY ODETTE

Art. 0830148N.C3A

PCS. 12

 4 x Ø 15 cm

 4 x Ø 19 cm

 4 x Ø 26 cm





€ tbc  
4 / 4 / -

### LUNCH BOX ODETTE

Art. 0830155N.C3A

PCS. 16

 4 x Ø 21 cm

 4 x Ø 19 cm

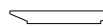
 4 x Ø 26 cm

 4 x 30 cl



€ tbc  
4 / 4 / 48

**Tazzone 30 cl**

Art. 0830051N.C3A

€ tbc  
12 / 36 / -











## 6 IN 1 ODETTTE

Art. 0830137N.C3A

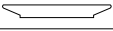
PCS. 7

	2 x Ø 21 cm
	2 x Ø 19 cm
	2 x Ø 26 cm
	1 x Ø 26 cm



€ tbc  
4/4/-

**Il set 6 in 1 è il risultato della nostra ricerca di una soluzione elegante, funzionale e salvaspazio da utilizzare per ogni viaggio, per il camping o per picnic all'aria aperta. Realizzato in melamina Stonetouch di alta qualità, è composto da ben 7 pezzi: 2 piatti piani, 2 piatti fondi, 2 piatti dessert più una capiente ciotola per insalata che contiene l'intero set, occupando veramente pochissimo spazio.**

Tutti gli elementi del set 6 in 1 convincono con le seguenti caratteristiche:

- Realizzati in speciale melamina Stonetouch alimentare
- Effetto porcellana
- Resistenti agli urti
- Completi di anello Antislip
- Impilabili
- Lavabili in lavastoviglie
- Senza BPA





## TÊTE-Â-TÊTE TUSCANY

Art. 0830143N.C5T

€ tbc

PCS. 8

6 / 6 / -



	2 x Ø 21 cm		2 x Ø 26 cm
	2 x Ø 15 cm		2 x 30 cl

## MIDDAY TUSCANY

Art. 0830148N.C5T

€ tbc

PCS. 12

4 / 4 / 88



	4 x Ø 15 cm		4 x Ø 26 cm
	4 x Ø 21 cm		

## LUNCH BOX TUSCANY

Art. 0830155N.C5T

€ tbc

PCS. 16

4 / 4 / 48



	4 x Ø 21 cm		4 x Ø 26 cm
	4 x Ø 21 cm		4 x 30 cl

## ALL INCLUSIVE TUSCANY

Art. 0830154N.C5T

€ tbc

PCS. 36

4 / 4 / 48



	4 x Ø 21 cm		4 x Ø 26 cm
	4 x Ø 21 cm		4 x 30 cl
	4 x 20 cl		16 pcs



# TUSCANY

STONEtouch®

### Piatto piano ø 26 cm

Art. 0830025N.C5T

€ tbc

12 / 24 / -



### Piatto dessert ø 21 cm

Art. 0830027N.C5T

€ tbc

12 / 48 / -



### Scodella ø 15 cm

Art. 0830043N.C5T

€ tbc

12 / 48 / -



### Portauovo

Art. 0830032N.C5T

€ tbc

12 / 72 / -



### Burriera 13,5 x 9,5 x H6,5 cm

Art. 0830099N.C48

€ tbc

12 / 24 / -



### Ciotola ovale 33x23xH7 cm

Art. 0830067N.C5T

€ tbc

6 / 12 / -



### Piatto fondo ø 21 cm

Art. 0830026N.C5T

€ tbc

12 / 36 / -



### Tazzone 30 cl

Art. 0830051N.C5T

€ tbc

12 / 36 / -



### Insalatiera ø 30 cm

Art. 0830030N.C5T

€ tbc

4 / 24 / -



### Bicchiere 25 cl

Art. 0830090N.C48

€ tbc

6 / 48 / -



### Set zuppiera 1x 55 cl / 1x 24x18 cm

Art. 0830049N.C5T

€ tbc

6 / 12 / 96



### Piatti da portata 40x28 cm / 35x25 cm

Art. 0830069N.C5T

€ tbc

6 / 6 / -



## ALL INCLUSIVE VIP TUSCANY

Art. 0830150N.C5T

PCS. 40

	4 x Ø 21 cm
	4 x Ø 21 cm
	4 x Ø 26 cm
	4 x Ø 15 cm
	4 x 30 cl
	4 x 20 cl
	16 pcs



€ tbc

4 / 4 / 48





## TÊTE-À-TÊTE GRANADA

Art. 0830143N.C3S

€ tbc  
6 / 6 / -

PCS. 8



	2 x Ø 21 cm		2 x Ø 26 cm
	2 x Ø 15 cm		2 x 30 cl

## MIDDAY GRANADA

Art. 0830148N.C3S

€ tbc  
4 / 4 / 8

PCS. 12



	4 x Ø 15 cm		4 x Ø 26 cm
	4 x Ø 21 cm		

## LUNCH BOX GRANADA

Art. 0830155N.C3S

€ tbc  
4 / 4 / 48

PCS. 16



	4 x Ø 21 cm		4 x Ø 26 cm
	4 x Ø 21 cm		4 x 30 cl

## ALL INCLUSIVE GRANADA

Art. 0830154N.C3S

€ tbc  
4 / 4 / 48

PCS. 36



	4 x Ø 21 cm		4 x Ø 26 cm
	4 x Ø 21 cm		4 x 30 cl
	4 x 20 cl		16 pcs

### Piatto piano ø 26 cm

Art. 0830025N.C3S

€ tbc  
12 / 24 / -

### Piatto dessert ø 21 cm

Art. 0830027N.C3S

€ tbc  
12 / 48 / -

### Scodella ø 15 cm

Art. 0830043N.C3S

€ tbc  
12 / 48 / -

### Portauovo

Art. 0830032N.C3S

€ tbc  
12 / 72 / -

### Burriera 13,5 x 9,5 x H6,5 cm

Art. 0830099N.C1M

€ tbc  
12 / 24 / -

### Ciotola ovale 33x23xH7 cm

Art. 0830067N.C3S

€ tbc  
6 / 12 / -

### Piatto fondo ø 21 cm

Art. 0830026N.C3S

€ tbc  
12 / 36 / -

### Tazzone 30 cl

Art. 0830051N.C1M

€ tbc  
12 / 36 / -

### Insalatiera ø 30 cm

Art. 0830030N.C3S

€ tbc  
4 / 24 / -

### Bicchiere 25 cl

Art. 0830090N.C1M

€ tbc  
6 / 48 / -

### Set zuppiera 1x 55 cl / 1x 24x18 cm

Art. 0830049N.C3S

€ tbc  
6 / 12 / -

### Piatti da portata 40x28 cm / 35x25 cm

Art. 0830069N.C3S

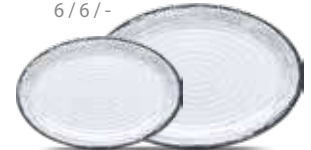
€ tbc  
6 / 6 / -

## ALL INCLUSIVE VIP GRANADA

Art. 0830150N.C3S

PCS. 40

	4 x Ø 21 cm
	4 x Ø 21 cm
	4 x Ø 26 cm
	4 x Ø 15 cm
	4 x 30 cl
	4 x 20 cl
	16 pcs

**VIP**  
STORAGE  
BOX
€ tbc  
4 / 4 / 48



# SAVANA

## STONEtouch®



**Piatto piano ø 26 cm**

Art. 0830025N.C4P

€ tbc

12 / 24 / -



**Piatto fondo ø 21 cm**

Art. 0830026N.C4P

€ tbc

12 / 36 / -



**Piatto dessert ø 21 cm**

Art. 0830027N.C4P

€ tbc

12 / 48 / -



**Tazzone 30 cl**

Art. 0830051N.C1C

€ tbc

12 / 36 / -



**Scodella ø 15 cm**

Art. 0830043N.C4P

€ tbc

12 / 48 / -



**Insalatiera ø 30 cm**

Art. 0830030N.C4P

€ tbc

4 / 24 / -



**Portauovo**

Art. 0830032N.C4P

€ tbc

12 / 72 / -



**Bicchieri 25 cl**

Art. 0830090N.C71

€ tbc

6 / 48 / -



**Burriera 13,5 x 9,5 x H6,5 cm**

Art. 0830099N.C4P

€ tbc

12 / 24 / -



**Set zuppiera 1x 55 cl / 1x 24x18 cm**

Art. 0830049N.C4P

€ tbc

6 / 12 / -



**Ciotola ovale 33x23xH7 cm**

Art. 0830067N.C4P

€ tbc

6 / 12 / -



**Piatti da portata 40x28 cm / 35x25 cm**

Art. 0830069N.C4P

€ tbc

6 / 6 / -



## ALL INCLUSIVE VIP SAVANA

Art. 0830150N.C4P

PCS. 40

4 x ø 21 cm

4 x ø 21 cm

4 x ø 26 cm

4 x ø 15 cm

4 x 30 cl

4 x 20 cl

16 pcs

**VIP  
box**



€ tbc  
4 / 4 / 48



## TÊTE-Â-TÊTE SAVANA

Art. 0830143N.C4P

PCS. 8

€ tbc

6 / 6 / -



2 x ø 21 cm

2 x ø 15 cm

2 x ø 26 cm

2 x 30 cl

## MIDDAY SAVANA

Art. 0830148N.C4P

PCS. 12

€ tbc

4 / 4 / 88



4 x ø 15 cm

4 x ø 21 cm

4 x ø 26 cm

## LUNCH BOX SAVANA

Art. 0830155N.C4P

PCS. 16

€ tbc

4 / 4 / 48



4 x ø 21 cm

4 x ø 21 cm

4 x ø 26 cm

4 x 30 cl

## ALL INCLUSIVE SAVANA

Art. 0830154N.C4P

PCS. 36

€ tbc

4 / 4 / 48



4 x ø 21 cm

4 x ø 21 cm

4 x 20 cl

4 x ø 26 cm

4 x 30 cl

16 pcs



# BELLAGIO

## STONEtouch®

**Piatto piano ø 26 cm**

Art. 0830025N.C4X

€ tbc  
12 / 24 / -**Piatto fondo ø 21 cm**

Art. 0830026N.C4X

€ tbc  
12 / 36 / -**Piatto dessert ø 21 cm**

Art. 0830027N.C4X

€ tbc  
12 / 48 / -**Tazzone 30 cl**

Art. 0830051N.C06

€ tbc  
12 / 36 / -**Scodella ø 15 cm**

Art. 0830043N.C4X

€ tbc  
12 / 48 / -**Insalatiera ø 30 cm**

Art. 0830030N.C4X

€ tbc  
4 / 24 / -**Portauovo**

Art. 0830032N.C4X

€ tbc  
12 / 72 / -**Bicchieri 25 cl**

Art. 0830090N.C71

€ tbc  
6 / 48 / -**Burriera 13,5 x 9,5 x H6,5 cm**

Art. 0830099N.C06

€ tbc  
12 / 24 / -**Set zuppiera 1x 55 cl / 1x 24x18 cm**

Art. 0830049N.C4X

€ tbc  
6 / 12 / -**Ciotola ovale 33x23xH7 cm**

Art. 0830067N.C4X

€ tbc  
6 / 12 / -**Piatti da portata 40x28 cm / 35x25 cm**

Art. 0830069N.C4X

€ tbc  
6 / 6 / -**ALL INCLUSIVE VIP BELLAGIO**

Art. 0830150N.C4X

PCS. 40

VIP  
BOX

	4 x Ø 21 cm
	4 x Ø 21 cm
	4 x Ø 26 cm
	4 x Ø 15 cm
	4 x 30 cl
	4 x 20 cl
	16 pcs

€ tbc  
4 / 4 / 48**TÊTE-Â-TÊTE BELLAGIO**

Art. 0830143N.C4X

PCS. 8

€ tbc  
6 / 6 / -

	2 x Ø 21 cm		2 x Ø 26 cm
	2 x Ø 15 cm		2 x 30 cl

**MIDDAY BELLAGIO**

Art. 0830148N.C4X

PCS. 12

€ tbc  
4 / 4 / 88

	4 x Ø 15 cm		4 x Ø 26 cm
	4 x Ø 21 cm		

**LUNCH BOX BELLAGIO**

Art. 0830155N.C4X

PCS. 16

€ tbc  
4 / 4 / 48

	4 x Ø 21 cm		4 x Ø 26 cm
	4 x Ø 21 cm		4 x 30 cl

**ALL INCLUSIVE BELLAGIO**

Art. 0830154N.C4X

PCS. 36

€ tbc  
4 / 4 / 48

	4 x Ø 21 cm		4 x Ø 26 cm
	4 x Ø 21 cm		4 x 30 cl
	4 x 20 cl		16 pcs





# AMALFI

## STONEtouch®



### TÊTE-Â-TÊTE AMALFI

Art. 0830143N.C5E

PCS. 8

€ tbc  
6 / 6 / -



	2 x Ø 21 cm		2 x Ø 25 cm
	2 x Ø 15 cm		2 x 30 cl



### MIDDAY AMALFI

Art. 0830148N.C5E

PCS. 12

€ tbc  
4 / 4 / 88



	4 x Ø 15 cm		4 x Ø 25 cm
	4 x Ø 21 cm		

### LUNCH BOX AMALFI

Art. 0830155N.C5E

PCS. 16

€ tbc  
4 / 4 / 48



	4 x Ø 21 cm		4 x Ø 25 cm
	4 x Ø 21 cm		4 x 30 cl

#### Piatto piano ø 25 cm

Art. 0830025N.C5E

€ tbc  
12 / 24 / -



#### Piatto dessert ø 21 cm

Art. 0830027N.C5E

€ tbc  
12 / 48 / -



#### Scodella ø 15 cm

Art. 0830043N.C5E

€ tbc  
12 / 48 / -



#### Portauovo

Art. 0830032N.C5E

€ tbc  
12 / 72 / -



#### Piatto fondo ø 21 cm

Art. 0830026N.C5E

€ tbc  
12 / 36 / -



#### Tazzone 30 cl

Art. 0830051N.C48

€ tbc  
12 / 36 / -



#### Insalatiera ø 24 cm

Art. 0830030N.C5E

€ tbc  
4 / 24 / -



#### Bicchiere 30 cl

Art. 0830195S.C08

€ tbc  
6 / 24 / -



### ALL INCLUSIVE VIP AMALFI

Art. 0830150N.C5E

PCS. 40

	4 x Ø 21 cm
	4 x Ø 21 cm
	4 x Ø 25 cm
	4 x Ø 15 cm
	4 x 30 cl
	4 x 20 cl
	16 pcs



€ tbc  
4 / 4 / 48





# VENETIAN

STONEtouch®



## TÊTE-À-TÊTE VENETIAN

Art. 0830143N.C9X  
PCS. 8

€ tbc  
6 / 6 / 48



	2 x Ø 21 cm		2 x Ø 25 cm
	2 x Ø 18 cm		2 x 30 cl



## MIDDAY VENETIAN

Art. 0830148N.C9X  
PCS. 12

€ tbc  
4 / 4 / 88



	4 x Ø 18 cm		4 x Ø 25 cm
	4 x Ø 21 cm		

## LUNCH BOX VENETIAN

Art. 0830155N.C9X  
PCS. 16

€ tbc  
4 / 4 / 48



	4 x Ø 21 cm		4 x Ø 25 cm
	4 x Ø 21 cm		4 x 30 cl

### Piatto piano ø 25 cm

Art. 0830025N.C9X € tbc  
12 / 24 / -



### Piatto fondo ø 21 cm

Art. 0830026N.C9X € tbc  
12 / 36 / -



### Piatto dessert ø 21 cm

Art. 0830027N.C9X € tbc  
12 / 48 / -



### Tazzone 30 cl

Art. 0830051N.C9X € tbc  
12 / 36 / -



### Scodella ø 18 cm

Art. 0830043N.C9X € tbc  
12 / 48 / -



### Insalatiera ø 24 cm

Art. 0830030N.C9X € tbc  
4 / 24 / -



### Portauovo

Art. 0830032N.C9X € tbc  
12 / 72 / -



### Bicchiere 30 cl

Art. 0830208S.C9X € tbc  
12 / 24 / -



## ALL INCLUSIVE VIP VENETIAN

Art. 0830150N.C9X  
PCS. 40

	4 x Ø 21 cm
	4 x Ø 21 cm
	4 x Ø 25 cm
	4 x Ø 18 cm
	4 x 30 cl
	4 x 20 cl
	16 pcs



€ tbc  
4 / 4 / 48





### Piatto piano ø 25 cm

Art. 0830025N.C5X

€ tbc  
12 / 24 / -



### Piatto fondo ø 19 cm

Art. 0830026N.C5X

€ tbc  
12 / 36 / -



### Piatto dessert ø 21 cm

Art. 0830027N.C5X

€ tbc  
12 / 48 / -



### Tazzone 30 cl

Art. 0830051N.C06

€ tbc  
12 / 36 / -



### Scodella ø 18 cm

Art. 0830043N.C5X

€ tbc  
12 / 48 / -



### Insalatiera ø 24 cm

Art. 0830030N.C5X

€ tbc  
4 / 24 / -



### Portauovo

Art. 0830032N.C5X

€ tbc  
12 / 72 / -



### Bicchiere 25 cl

Art. 0830090N.C1M

€ tbc  
6 / 48 / -



# PEARL

## STONEtouch



## MIDDAY PEARL

Art. 0830148N.C5X

PCS. 12

€ tbc  
4 / 4 / 88



	4 x Ø 18 cm
	4 x Ø 21 cm
	4 x Ø 25 cm

## TÊTE-Â-TÊTE PEARL

Art. 0830143N.C5X

PCS. 8

€ tbc  
6 / 6 / -



	2 x Ø 19 cm
	2 x Ø 25 cm
	2 x Ø 18 cm
	2 x Ø 18 cm

## LUNCH BOX PEARL

Art. 0830155N.C5X

PCS. 16

€ tbc  
4 / 4 / 48



	4 x Ø 19 cm
	4 x Ø 21 cm
	4 x Ø 25 cm
	4 x 30 cl

## ALL INCLUSIVE VIP PEARL

Art. 0830150N.C5X

PCS. 40

€ tbc  
4 / 4 / 48



	4 x Ø 19 cm
	4 x Ø 21 cm
	4 x Ø 25 cm
	4 x Ø 18 cm
	4 x 30 cl
	4 x 20 cl
	16 pcs



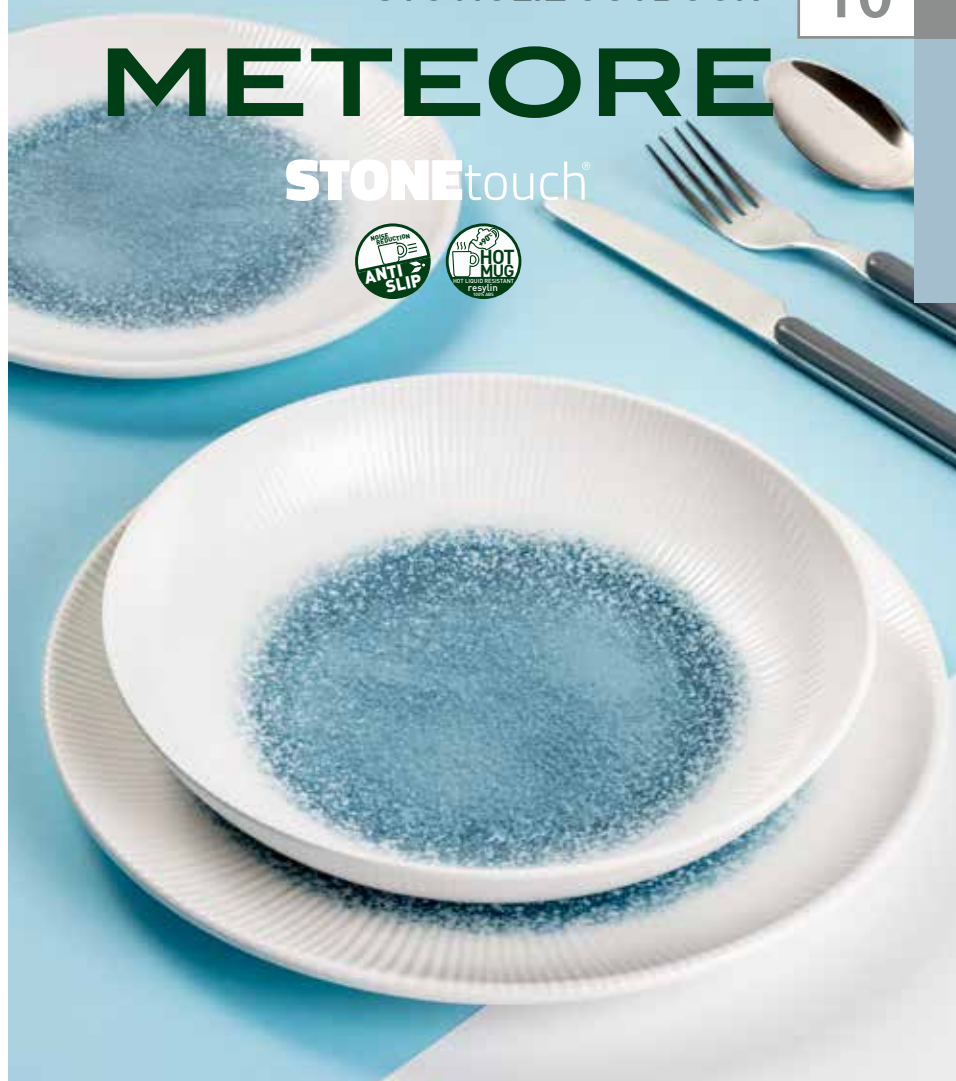

**Piatto piano ø 25 cm**Art. 0830025N.C1X € tbc  
12 / 24 / -**Piatto fondo ø 21 cm**Art. 0830026N.C1X € tbc  
12 / 36 / -**Piatto dessert ø 20 cm**Art. 0830027N.C1X € tbc  
12 / 48 / -**Tazzone 30 cl**Art. 0830051N.C48 € tbc  
12 / 36 / -**Portauovo**Art. 0830032N.C1X € tbc  
12 / 72 / -**Scodella ø 15 cm**Art. 0830062N.C1X € tbc  
12 / 48 / -**ACRYLIC****Insalatiera ø 24 cm**Art. 0830068N.C1X € tbc  
4 / 24 / -**ACRYLIC****METEORE****STONEtouch®****TÊTE-Â-TÊTE METEORE**

Art. 0830143N.C1X

PCS. 8

€ tbc  
6 / 6 / -

	2 x Ø 21 cm
	2 x Ø 25 cm
	2 x Ø 15 cm
	2 x 30 cl

**MIDDAY METEORE**

Art. 0830148N.C1X

PCS. 12

€ tbc  
4 / 4 / 48

	4 x Ø 15 cm
	4 x Ø 20 cm
	4 x Ø 25 cm

**ALL INCLUSIVE VIP METEORE**

Art. 0830150N.C1X

PCS. 40

**VIP  
STORAGE  
BOX**€ tbc  
4 / 4 / 48

	4 x Ø 21 cm
	4 x Ø 20 cm
	4 x Ø 25 cm
	4 x Ø 15 cm
	4 x 30 cl
	4 x 20 cl
	16 pcs

**LUNCH BOX METEORE**

Art. 0830155N.C1X

PCS. 16

€ tbc  
4 / 4 / 48

	4 x Ø 21 cm		4 x Ø 25 cm
	4 x Ø 20 cm		4 x 30 cl





# AMADÈ

## STONEtouch®



### SET WATERGLASS

Art. 0830221N.C71

€ tbc  
2 / 6 / -

45 cl

PACK 2X



### SET WINEGLASS

Art. 0830223N.C71

€ tbc  
2 / 6 / -

60 cl

PACK 2X



### Piatto piano ø 25 cm

Art. 0830025N.C8X

€ tbc  
12 / 24 / -



### Piatto fondo ø 20 cm

Art. 0830026N.C8X

€ tbc  
12 / 36 / -



### Piatto dessert ø 20 cm

Art. 0830027N.C8X

€ tbc  
12 / 48 / -



### Tazzone 30 cl

Art. 0830051N.C1C

€ tbc  
12 / 36 / -



### Scodella ø 20 cm

Art. 0830043N.C8X

€ tbc  
12 / 48 / -



### Insalatiera ø 30 cm

Art. 0830030N.C8X

€ tbc  
4 / 24 / -



### Portauovo

Art. 0830032N.C8X

€ tbc  
12 / 72 / -



### MIDDAY AMADÈ

Art. 0830148N.C8X

PCS. 12

€ tbc  
4 / 4 / 88

- 4 x Ø 20 cm
- 4 x Ø 20 cm
- 4 x Ø 25 cm



### TÊTE-Â-TÊTE AMADÈ

Art. 0830143N.C8X

PCS. 8

€ tbc  
6 / 6 / -

- 2 x Ø 20 cm
- 2 x Ø 25 cm
- 2 x Ø 20 cm
- 2 x 30 cl



### LUNCH BOX AMADÈ

Art. 0830155N.C8X

PCS. 16

€ tbc  
4 / 4 / 48

- 4 x Ø 20 cm
- 4 x Ø 20 cm
- 4 x Ø 25 cm
- 4 x 30 cl



### ALL INCLUSIVE VIP AMADÈ

Art. 0830150N.C8X

PCS. 40

€ tbc  
4 / 4 / 48

- 4 x Ø 20 cm
- 4 x Ø 20 cm
- 4 x Ø 25 cm
- 4 x Ø 20 cm
- 4 x 30 cl
- 4 x 20 cl
- 16 pcs





# COTTERY

## PREMIUM CLASSIC

### Piatto piano ø 25 cm

Art. 0830025N.C9B

€ tbc  
12 / 24 / -

### Piatto fondo ø 21 cm

Art. 0830026N.C9B

€ tbc  
12 / 36 / -

### Piatto dessert ø 20 cm

Art. 0830027N.C9B

€ tbc  
12 / 48 / -
**NEW  
2023**

### Tazzone 30 cl

Art. 0830035N.C9B

€ tbc  
12 / 36 / -

### WATER GLASS GREY

Art. 0830200N.C06

€ tbc  
2 / 12 / -
 30 cl

PACK 2X



### SET WINEGLASS THANGO GREY

Art. 0830184N.C06

€ tbc  
2 / 6 / -
 60 cl

PACK 2X



### Scodella ø 15 cm

Art. 0830043N.C9B

€ tbc  
12 / 48 / -

### Insalatiera ø 23,5 cm

Art. 0830030N.C9B

€ tbc  
4 / 24 / -

## TÊTE-Â-TÊTE COTTERY

Art. 0830143N.C9B

PCS. 8

€ tbc  
6 / 6 / -

	2 x Ø 21 cm
	2 x Ø 25 cm
	2 x Ø 15 cm
	2 x 30 cl



## MIDDAY COTTERY

Art. 0830148N.C9B

PCS. 12

€ tbc  
4 / 4 / -

	4 x Ø 15 cm
	4 x Ø 20 cm
	4 x Ø 25 cm



## LUNCH BOX COTTERY

Art. 0830155N.C9B

PCS. 16

€ tbc  
4 / 4 / -

	4 x Ø 21 cm
	4 x Ø 20 cm
	4 x Ø 25 cm
	4 x 30 cl



## ALL INCLUSIVE COTTERY

Art. 0830154N.C9B

PCS. 36

€ tbc  
4 / 4 / 48

	4 x Ø 21 cm
	4 x Ø 20 cm
	4 x Ø 25 cm
	4 x 30 cl
	4 x 20 cl
	16 pcs





# KASSANDRA

## PREMIUM CLASSIC

**Piatto piano ø 25 cm**

Art. 0830025N.C2K

€ tbc  
12 / 24 / -



**Tazzone 30 cl**

Art. 0830035N.C2K

€ tbc  
12 / 36 / -



**Piatto fondo ø 21 cm**

Art. 0830026N.C2K

€ tbc  
12 / 36 / -



**Scodella ø 15 cm**

Art. 0830043N.C2K

€ tbc  
12 / 48 / -



**Piatto dessert ø 20 cm**

Art. 0830027N.C2K

€ tbc  
12 / 48 / -



**Insalatiera ø 23,5 cm**

Art. 0830030N.C2K

€ tbc  
4 / 24 / -



### SET WATERGLASS BROWNSATIN

Art. 0830183N.C02

€ tbc  
2 / 6 / -

✓ 35 cl

PACK 2X

### SET WINEGLASS BROWNSATIN

Art. 0830184N.C02

€ tbc  
2 / 6 / -

✓ 60 cl

PACK 2X



### TÊTE-Â-TÊTE KASSANDRA

Art. 0830143N.C2K

PCS. 8

2 x Ø 21 cm

2 x Ø 25 cm

2 x Ø 15 cm

2 x 30 cl



€ tbc  
6 / 6 / -

### MIDDAY KASSANDRA

Art. 0830148N.C2K

PCS. 12

4 x Ø 15 cm

4 x Ø 20 cm

4 x Ø 25 cm



€ tbc  
4 / 4 / 88

### LUNCH BOX KASSANDRA

Art. 0830155N.C2K

PCS. 16

4 x Ø 21 cm

4 x Ø 20 cm

4 x Ø 25 cm

4 x 30 cl



€ tbc  
4 / 4 / 48

### ALL INCLUSIVE KASSANDRA

Art. 0830154N.C2K

PCS. 36

4 x Ø 21 cm

4 x Ø 20 cm

4 x Ø 25 cm

4 x 30 cl

4 x 20 cl

16 pcs



€ tbc  
4 / 4 / 48



# TIVOLI

## PREMIUM CLASSIC

### Piatto piano ø 25 cm

Art. 0830025N.C7X

€ tbc  
12 / 24 / -

### Tazzone 30 cl

Art. 0830035N.C7X

€ tbc  
12 / 36 / -

### Piatto fondo ø 21 cm

Art. 0830026N.C7X

€ tbc  
12 / 36 / -

### Scodella ø 15 cm

Art. 0830043N.C7X

€ tbc  
12 / 48 / -

### Piatto dessert ø 20 cm

Art. 0830027N.C7X

€ tbc  
12 / 48 / -

### Insalatiera ø 23,5 cm

Art. 0830030N.C7X

€ tbc  
4 / 24 / -

## SET WATERGLASS BLACKSATIN

Art. 0830183N.C1M

€ tbc  
2 / 6 / -
 35 cl

PACK 2X

## SET WINEGLASS BLACKSATIN

Art. 0830184N.C1M

€ tbc  
2 / 6 / -
 60 cl



PACK 2X



## TÊTE-Â-TÊTE TIVOLI

Art. 0830143N.C7X

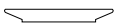
PCS. 8

	2 x Ø 21 cm
	2 x Ø 25 cm
	2 x Ø 15 cm
	2 x 30 cl

€ tbc  
6 / 6 / -

## MIDDAY TIVOLI

Art. 0830148N.C7X

PCS. 12

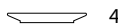
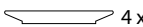



	4 x Ø 15 cm
	4 x Ø 20 cm
	4 x Ø 25 cm

€ tbc  
4 / 4 / 88

## LUNCH BOX TIVOLI

Art. 0830155N.C7X

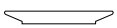
PCS. 16







	4 x Ø 21 cm
	4 x Ø 20 cm
	4 x Ø 25 cm
	4 x 30 cl

€ tbc  
4 / 4 / 48

## ALL INCLUSIVE TIVOLI

Art. 0830154N.C7X

PCS. 36

	4 x Ø 21 cm
	4 x Ø 20 cm
	4 x Ø 25 cm
	4 x 30 cl
	4 x 20 cl
	16 pcs

€ tbc  
4 / 4 / 48

# GRANYTE

## PREMIUM CLASSIC



### SET WATERGLASS CORALUX

Art. 0830230N.C25

35 cl

PACK 2X



€ tbc  
2 / 6 / -

### SET WINEGLASS CORALUX

Art. 0830231N.C25

40 cl

PACK 2X



€ tbc  
2 / 6 / -

### TÊTE-Â-TÊTE GRANYTE

Art. 0830143N.C1M

PCS. 8

€ tbc  
6 / 6 / -

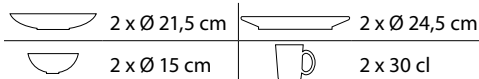

### MIDDAY GRANYTE

Art. 0830148N.C1M

PCS. 12

€ tbc  
4 / 4 / 48

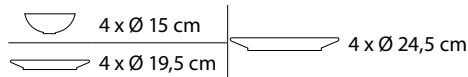

### LUNCH BOX GRANYTE

Art. 0830155N.C1M

PCS. 16

€ tbc  
4 / 4 / 48

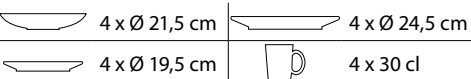

#### Piatto piano ø 24,5 cm

Art. 0830025N.C1M

€ tbc  
12 / 36 / -



#### Piatto fondo ø 21,5 cm

Art. 0830026N.C1M

€ tbc  
12 / 36 / -



#### Piatto dessert ø 19,5 cm

Art. 0830027N.C1M

€ tbc  
12 / 48 / -



#### Tazzone 30 cl

Art. 0830051N.C1M

€ tbc  
12 / 36 / -



#### Scodella ø 15 cm

Art. 0830043N.C1M

€ tbc  
12 / 48 / -



#### Insalatiera ø 23,5 cm

Art. 0830030N.C1M

€ tbc  
4 / 24 / -



#### Portauovo

Art. 0830032N.C1M

€ tbc  
12 / 72 / -



#### Burriera 13,5 x 9,5 x H6,5 cm

Art. 0830099N.C1M

€ tbc  
12 / 24 / -



#### Tazzina espresso

Art. 0830063N.C35

€ tbc  
6 / 48 / -



#### Insalatiera ø 25 cm

Art. 0830044N.C1M

€ tbc  
1 / 6 / -



### ALL INCLUSIVE GRANYTE

Art. 0830154N.C1M

PCS. 36

€ tbc  
4 / 4 / 48

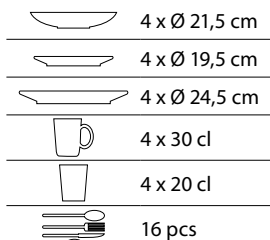



# SANDHYA

PREMIUM CLASSIC



**Piatto piano ø 26 cm**

Art. 0830025N.C2E

€ tbc  
12 / 36 / -



**Piatto fondo ø 23,5 cm**

Art. 0830026N.C2E

€ tbc  
12 / 36 / -



**Piatto dessert ø 21 cm**

Art. 0830027N.C2E

€ tbc  
12 / 48 / -



**Bicchiere 30 cl**

Art. 0830185N.C2E

€ tbc  
6 / 12 / -



**Scodella ø 15 cm**

Art. 0830043N.C2E

€ tbc  
12 / 48 / -



**Insalatiera ø 23,5 cm**

Art. 0830030N.C2E

€ tbc  
4 / 24 / -



**Portauovo**

Art. 0830032N.C2E

€ tbc  
12 / 72 / -



**Burriera**

Art. 0830059N.C2E

€ tbc  
12 / 24 / -



**Tagliere 23,5x14,5 cm**

Art. 0830021N.C2E

€ tbc  
12 / 48 / -



**Tazzina espresso 10 cl**

Art. 0830055N.C34

€ tbc  
6 / 48 / -



## ALL INCLUSIVE SANDHYA

Art. 0830154N.C2E

PCS. 36+1

	4 x Ø 23,5 cm
	4 x Ø 21 cm
	4 x Ø 26 cm
	4 x 30 cl
	4 x 20 cl
	16 pcs



€ tbc  
4 / 4 / 48



**Tazzone 30 cl**

Art. 0830051N

€ tbc  
12 / 36 / -



C08



C34



C06

## TÊTE-À-TÊTE SANDHYA

Art. 0830143N.C2E

PCS. 8

€ tbc

6 / 6 / -



	2 x Ø 23,5 cm		2 x Ø 26 cm
	2 x Ø 15 cm		2 x 30 cl

## MIDDAY SANDHYA

Art. 0830148N.C2E

PCS. 12

€ tbc

4 / 4 / 88



	4 x Ø 15 cm		4 x Ø 26 cm
	4 x Ø 21 cm		

## DINNER SERVICE SANDHYA

Art. 0830151N.C2E

PCS. 16

€ tbc

4 / 4 / 48



	4 x Ø 23,5 cm		4 x Ø 26 cm
	4 x Ø 21 cm		4 x 30 cl

**Piatto piano ø 25 cm**

Art. 0830025N.C7B

€ tbc  
12 / 36 / -**Piatto fondo ø 21 cm**

Art. 0830026N.C7B

€ tbc  
12 / 36 / -**Piatto dessert ø 20 cm**

Art. 0830027N.C7B

€ tbc  
12 / 48 / -**Scodella ø 15 cm**

Art. 0830043N.C7B

€ tbc  
12 / 48 / -**Insalatiera ø 23,5 cm**

Art. 0830030N.C7B

€ tbc  
4 / 24 / -**Portauovo**

Art. 0830032N.C7B

€ tbc  
12 / 72 / -**Coperchio per scodelle ø 15 cm**

Art. 0830020N.C7B

€ tbc  
12 / 48 / -**Tazza con coperchio 30 cl**

Art. 0830023N.C7B

€ tbc  
12 / 48 / -**Bicchiere 30 cl**

Art. 0830185N.C7B

€ tbc  
6 / 12 / -**Bicchiere 40 cl**

Art. 0830187S.C7B

€ tbc  
6 / 12 / -**Burriera**

Art. 0830059N.C7B

€ tbc  
12 / 24 / -**Vassoio ø 30 cm**

Art. 0830080N.C7B

€ tbc  
4 / 8 / -**Tagliere 23,5x14,5 cm**

Art. 0830021N.C7B

€ tbc  
12 / 48 / -**Lattiera 30 cl**

Art. 0830058N.C7B

€ tbc  
12 / 24 / -**MUG SET**

Art. 0830051C.C34

PCS. 4



Set tazzoni in Resylin di alta qualità.

€ tbc  
2 / 8 / -**SET MULTIGLASS SPACE**

Art. 0830185C.C7B

PCS. 3



Bicchiere sovrapponibile. Materiale: SAN ad uso alimentare. 30 cl

€ tbc  
2 / 8 / -**FESTA SPACE**

Art. 0830187N.C7B

PCS. 2



Grande bicchiere impilabile in acrilico alimentare. 40 cl.

€ tbc  
6 / 12 / -



**Tazza con piattino 25 cl**Art. 0830022N.C34 € tbc  
6 / 36 / -**Tazzina espresso 10 cl**Art. 0830055N.C34 € tbc  
6 / 48 / -**Contenitore ø 12x14,5 cm**Art. 0830040N.C34 € tbc  
4 / 48 / -**Posate insalata**Art. 0830039N.C34 € tbc  
6 / 48 / -**Cestino pane 24x24 cm**Art. 0830060N.C34 € tbc  
12 / 36 / -**Tagliere/vassoio 36x24 cm**Art. 0830056N.C34 € tbc  
6 / 12 / -**Tazzone 30 cl**Art. 0830051N.C34 € tbc  
12 / 36 / -

# SPACE

## PREMIUM CLASSIC



### TÊTE-Â-TÊTE SPACE

Art. 0830143N.C7B

PCS. 8

	2 x Ø 21 cm
	2 x Ø 25 cm
	2 x Ø 15 cm
	2 x 30 cl

€ tbc  
6 / 6 / -

### MIDDAY SPACE

Art. 0830148N.C7B

PCS. 12

	4 x Ø 15 cm
	4 x Ø 20 cm
	4 x Ø 25 cm

€ tbc  
4 / 4 / 88

### LUNCH BOX SPACE

Art. 0830155N.C7B

PCS. 16

	4 x Ø 21 cm
	4 x Ø 20 cm
	4 x Ø 25 cm
	4 x 30 cl

€ tbc  
4 / 4 / 48

### ALL INCLUSIVE SPACE

Art. 0830154N.C7B

PCS. 36+1

	4 x Ø 21 cm
	4 x Ø 20 cm
	4 x Ø 25 cm
	4 x 30 cl
	4 x 20 cl
	16 pcs

€ tbc  
4 / 4 / 48

+1

# DOLOMIT

## PREMIUM CLASSIC



**Piatto piano ø 26 cm**

Art. 0830025N

€ tbc  
12 / 36 / -



C00



C43



C28



C20

**Piatto fondo ø 21 cm**

Art. 0830026N

€ tbc  
12 / 36 / -



C00



C43



C28



C20

**Scodella ø 15 cm**

Art. 0830043N

€ tbc  
12 / 48 / -



C00



C43



C28



C20

**Piatto dessert ø 21 cm**

Art. 0830027N

€ tbc  
12 / 48 / -



C00



C43



C28



C20

**Portauovo**

Art. 0830032N

€ tbc  
12 / 72 / -



C00



C43



C28



C20

**Tazzone 30 cl**

Art. 0830051N

€ tbc  
12 / 36 / -



C00



C43



C28



C20

**Bicchiere 30 cl**

Art. 0830214S

€ tbc  
4 / 12 / -



C00



C43



C28



C20

**Insalatiera ø 25 cm**

Art. 0830030N

€ tbc  
4 / 24 / -



C00



C43



C28



C20



**ONDA**

Art. 0830214N

V 300 ml

PACK 4X

€ tbc  
6/12/-



**ONDA & JAZZ WINEGLASS**

Art. 0830184C.C9N

V 60 cl

PACK 4X

€ tbc  
2/6/72





**MIDDAY DOLOMIT**

Art. 0830148N.C2P

PCS. 12

€ tbc  
4/4/88

-  4 x Ø 15 cm
-  4 x Ø 21 cm
-  4 x Ø 26 cm



**MUG SET DOLOMIT**

Art. 0830051C.C2P

PCS. 4

€ tbc  
2/8/-



**LUNCH BOX DOLOMIT**

Art. 0830155N.C2P

PCS. 16

€ tbc  
4/4/48

-  4 x Ø 21 cm
-  4 x Ø 21 cm
-  4 x Ø 26 cm
-  4 x 30 cl









**ALL INCLUSIVE DOLOMIT**

Art. 0830154N.C2P

PCS. 36

€ tbc  
4/4/48

-  4 x Ø 21 cm
-  4 x Ø 21 cm
-  4 x Ø 26 cm
-  4 x 30 cl
-  4 x 20 cl
-  16 pcs





# SPECTRUM

## PREMIUM CLASSIC



### Piatto piano ø 25 cm

Art. 0830025N.C1P

€ tbc  
12 / 36 / -



### Piatto dessert ø 20 cm

Art. 0830027N.C1P

€ tbc  
12 / 48 / -



### Insalatiera ø 23,5 cm

Art. 0830030N.C1P

€ tbc  
4 / 24 / -



### APPETIZER

Art. 0830042N.C9N

35,5 x 8,5 x H 5,5 cm

€ tbc  
4 / 16 / -



Eleganti ciotoline per aperitivo. Realizzate in melamina di alta qualità. Complete di vassoio.

### Posate insalata

Art. 0830039N

€ tbc  
6 / 48 / -

COLORS C30 C10 C34



### Contenitore ø 12x14,5 cm

Art. 0830040N

€ tbc  
4 / 48 / -

COLORS C30 C10 C34



### MUG SET SPECTRUM

Art. 0830051C.C9N

PCS. 4

€ tbc  
2 / 8 / -



Set tazzoni in Resylin di alta qualità.

### Cestino pane 24x24 cm

Art. 0830060N

€ tbc  
12 / 36 / -

COLORS C30 C34 C11



### Tagliere/vassoio 36x24 cm

Art. 0830056N

€ tbc  
6 / 12 / -

COLORS C30 C34 C11



### SPICE BOX

Art. 0830010N.C9N

8 x Ø 6 cm

56 g

4 x 50 ml

€ tbc  
24 / 96 / -



Pratico portaspesie in plastica di alta qualità. 4 comparti separati. 6 colori assortiti.

### OLIAC

Art. 0830000N.C9N

2 x 130 ml

€ tbc  
12 / 12 / -



Oliera e acetiera con sistema di chiusura a tenuta. Colori Spectrum assortiti.

### GRATTÙ

Art. 0830017N

€ tbc  
12 / 12 / -



Set grattugia composto da 4 grattugie a fori differenti per sminuzzare alimenti in modo diverso. Materiale: PP/acciaio inox.



## Scodella ø 15 cm

Art. 0830043N

€ tbc  
12 / 48 / -

C30



C10



C34



C11

## Piatto fondo ø 21 cm

Art. 0830026N

€ tbc  
12 / 36 / -

C30



C10



C34



C11

## Tazzone 30 cl

Art. 0830051N

€ tbc  
12 / 36 / -

C30



C10



C34



C11

## Tazzina espresso 10 cl

Art. 0830055N

€ tbc  
6 / 48 / -

C30



C10



C34



C11

## Tazza con piattino 25 cl

Art. 0830022N

€ tbc  
6 / 36 / -

C30



C10



C34



C11

## MUG'N SPOON

Art. 0830061N.C9N

€ tbc  
12 / 48 / -

Tazzone con cucchiaino in melamina colorata. Impilabile e salvaspazio.

## MINI SPOON SET

Art. 0830129N.C9N

PCS. 4

€ tbc  
24 / 48 / -

## SPOON SET

Art. 0830128N.C9N

PCS. 4

€ tbc  
24 / 96 / -

## LUNCH BOX SPECTRUM

Art. 0830155N.C9N

PCS. 16



	4 x Ø 21 cm		4 x Ø 25 cm
	4 x Ø 20 cm		4 x 30 cl

## ALL INCLUSIVE SPECTRUM

Art. 0830154N.C9N

PCS. 36

€ tbc  
4 / 4 / 48

	4 x Ø 21 cm		4 x Ø 25 cm
	4 x Ø 20 cm		4 x 30 cl
	4 x 20 cl		16 pcs

## SET ESPRESSO SPECTRUM

Art. 0830055C.C30

PCS. 2

COLORS

€ tbc  
4 / 24 / -



# BLUE OCEAN

## SEVEN SEAS



Contenitore ø 12x14,5 cm

Art. 0830040N.C8C € tbc  
4 / 48 / -



Posate insalata

Art. 0830039N.C8C € tbc  
6 / 48 / -



Portacenere

Art. 0830071N.C22 € tbc  
6 / 48 / -



Cestino pane 24x24 cm

Art. 0830060N.C22 € tbc  
12 / 36 / -



Tagliere/vassoio 36x24 cm

Art. 0830056N.C22 € tbc  
6 / 12 / -



Appetizer 35,5x8,5xH5,5 cm

Art. 0830042N.C8C € tbc  
4 / 16 / -



### MUG SET

Art. 0830051C.C22  
PCS. 4

€ tbc  
2 / 8 / -



Set tazzoni in Resylin di alta qualità.

### MUG SET BLUE OCEAN

Art. 0830024C.C8C  
PCS. 4

€ tbc  
6 / 24 / -



Set tazzoni in melamina di alta qualità.

### ALL INCLUSIVE BLUE OCEAN

Art. 0830154N.C8C  
PCS. 36+1

€ tbc  
4 / 4 / 48



### SET MULTIGLASS BLUE OCEAN

Art. 0830185C.C8C  
PCS. 3

€ tbc  
2 / 8 / -



Bicchiere sovrapponibile. Materiale: SAN ad uso alimentare. 30 cl

### FESTA BLUE OCEAN

Art. 0830187N.C8C  
PCS. 2

€ tbc  
6 / 12 / -



Grande bicchiere impilabile in acrilico alimentare. 40 cl.

	4 x Ø 21 cm
	4 x Ø 20 cm
	4 x Ø 25 cm
	4 x 30 cl
	4 x 20 cl
	16 pcs



Piatto piano ø 25 cm

Art. 0830025N.C8C

€ tbc  
12 / 36 / -



Piatto fondo ø 21 cm

Art. 0830026N.C8C

€ tbc  
12 / 36 / -



Piatto dessert ø 20 cm

Art. 0830027N.C8C

€ tbc  
12 / 48 / -



Tazzone 30 cl

Art. 0830051N.C22

€ tbc  
12 / 36 / -



Tazzone 30 cl

Art. 0830024N.C8C

€ tbc  
12 / 48 / -



Lattiera 30 cl

Art. 0830058N.C8C

€ tbc  
12 / 24 / -



Tazzina espresso 10 cl

Art. 0830055N.C8C

€ tbc  
6 / 48 / -



Tazza con piattino 25 cl

Art. 0830022N.C8C

€ tbc  
6 / 36 / -



Burriera

Art. 0830059N.C8C

€ tbc  
12 / 24 / -



Scodella ø 15 cm

Art. 0830043N.C8C

€ tbc  
12 / 48 / -



Insalatiera ø 23,5 cm

Art. 0830030N.C8C

€ tbc  
4 / 24 / -



Portauovo

Art. 0830032N.C8C

€ tbc  
12 / 72 / -



Tagliere 23,5x14,5 cm

Art. 0830021N.C8C

€ tbc  
12 / 48 / -



Vassoio 29,5 x 40 cm

Art. 0830081N.C8C

€ tbc  
6 / 6 / 90



Bicchieri 30 cl

Art. 0830185N.C8C

€ tbc  
6 / 12 / -



Bicchieri 40 cl

Art. 0830187S.C8C

€ tbc  
6 / 12 / -



**SET WINEGLASS THANGO BLUE**

Art. 0830184N.C22

€ tbc  
2 / 6 / -

60 cl

PACK 4X

**LUNCH BOX BLUE OCEAN**

Art. 0830155N.C8C

PCS. 16

€ tbc  
4 / 4 / 48

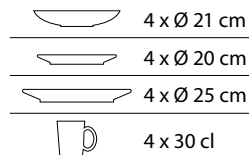

**MIDDAY BLUE OCEAN**

Art. 0830148N.C8C

PCS. 12

€ tbc  
4 / 4 / 88

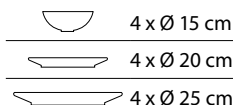

**STACK BOX BLUE OCEAN**

Art. 0830152N.C8C

PCS. 16

€ tbc  
4 / 4 / -

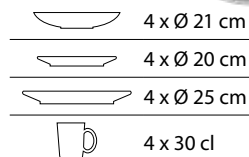

**TÊTE-Â-TÊTE BLUE OCEAN**

Art. 0830143N.C8C

PCS. 8

€ tbc  
6 / 6 / -

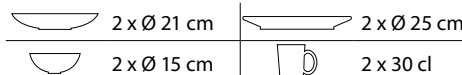



## TÊTE-Â-TÊTE NAUTICAL

Art. 0830143N.C8S

PCS. 8

€ tbc

6 / 6 / -



	2 x Ø 23,5 cm		2 x Ø 26 cm
	2 x Ø 15 cm		2 x 30 cl

## MIDDAY NAUTICAL

Art. 0830148N.C8S

PCS. 12

€ tbc

4 / 4 / 88



	4 x Ø 15 cm		4 x Ø 26 cm
	4 x Ø 21 cm		

## DINNER SERVICE NAUTICAL

Art. 0830151N.C8S

PCS. 16

€ tbc

4 / 4 / 48



	4 x Ø 23,5 cm		4 x Ø 26 cm
	4 x Ø 21 cm		4 x 30 cl

## ALL INCLUSIVE NAUTICAL

Art. 0830154N.C8S

PCS. 36+1

€ tbc

4 / 4 / 48



	4 x Ø 23,5 cm		4 x Ø 26 cm
	4 x Ø 21 cm		4 x 30 cl
	4 x 20 cl		16 pcs

# NAUTICAL

## SEVEN SEAS



Piatto piano ø 26 cm

Art. 0830025N.C8S

€ tbc

12 / 36 / -



Piatto fondo ø 23,5 cm

Art. 0830026N.C8S

€ tbc

12 / 36 / -



Piatto dessert ø 21 cm

Art. 0830027N.C8S

€ tbc

12 / 48 / -



Bicchiere 30 cl

Art. 0830185N.C8S

€ tbc

6 / 12 / -



Portauovo

Art. 0830032N.C8S

€ tbc

12 / 72 / -



Tazzone 30 cl

Art. 0830024N.C8S

€ tbc

12 / 48 / -



Scodella ø 15 cm

Art. 0830043N.C8S

€ tbc

12 / 48 / -



Insalatiera ø 23,5 cm

Art. 0830030N.C8S

€ tbc

4 / 24 / -



Tagliere 23,5x14,5 cm

Art. 0830021N.C8S

€ tbc

12 / 48 / -



Tazzone 30 cl

Art. 0830051N.C22

€ tbc

12 / 36 / -



Tazzina espresso 10 cl

Art. 0830055N.C22

€ tbc

6 / 48 / -



Lattiera 30 cl

Art. 0830058N.C22

€ tbc

12 / 24 / -



Burriera 13,5 x 9,5 x H6,5 cm

Art. 0830099N.C22

€ tbc

12 / 24 / -



## SET WINEGLASS THANGO BLUE

Art. 0830184N.C22

€ tbc

2 / 6 / -

60 cl

PACK 4X



# SPHERICA

## ALLROUND



**Piatto piano ø 24,5 cm**

Art. 0830025N.C7T

€ tbc  
12 / 24 / -



**Piatto fondo ø 20 cm**

Art. 0830026N.C7T

€ tbc  
12 / 36 / -



**Piatto dessert ø 20 cm**

Art. 0830027N.C7T

€ tbc  
12 / 48 / -



**Scodella ø 16 cm**

Art. 0830043N.C7T

€ tbc  
12 / 48 / -



**Tazzone 30 cl**

Art. 0830035N.C7T

€ tbc  
12 / 36 / -



**tritan™**  
from eastman



### SET WINEGLASS SPHERICA

Art. 0830225N.C71

✓ 60 cl

PACK 2X

€ tbc  
2 / 6 / 72

**Portauovo**

Art. 0830032N.C7T

€ tbc  
12 / 72 / -



**Insalatiera ø 25 cm**

Art. 0830030N.C7T

€ tbc  
4 / 24 / -



### ALL INCLUSIVE SPHERICA

Art. 0830154N.C7T

PCS. 36

€ tbc  
4 / 4 / 48



4 x ø 20 cm | 4 x ø 24,5 cm

4 x ø 20 cm | 4 x 30 cl

4 x 20 cl | 16 pcs

### TÊTE-Â-TÊTE SPHERICA

Art. 0830143N.C7T

PCS. 8

€ tbc  
6 / 6 / -



2 x ø 20 cm | 2 x ø 24,5 cm  
2 x ø 16 cm | 2 x 30 cl

### MIDDAY SPHERICA

Art. 0830148N.C7T

PCS. 12

€ tbc  
4 / 4 / 88



4 x ø 16 cm | 4 x ø 24,5 cm  
4 x ø 20 cm

### SET SPHERICA

Art. 0830160N.C7T

PCS. 16

€ tbc  
4 / 4 / 56



4 x ø 20 cm | 4 x ø 24,5 cm  
4 x ø 20 cm | 4 x 30 cl



## TÊTE-Â-TÊTE DEEP SEA

Art. 0830143N.C7R

PCS. 8

€ tbc

6 / 6 / -



	2 x Ø 21 cm		2 x Ø 25 cm
	2 x Ø 15 cm		2 x 30 cl

## MIDDAY DEEP SEA

Art. 0830148N.C7R

PCS. 12

€ tbc

4 / 4 / 88



	4 x Ø 15 cm		4 x Ø 25 cm
	4 x Ø 20 cm		

## LUNCH BOX DEEP SEA

Art. 0830155N.C7R

PCS. 16

€ tbc

4 / 4 / 48



	4 x Ø 21 cm		4 x Ø 25 cm
	4 x Ø 20 cm		4 x 30 cl

## ALL INCLUSIVE DEEP SEA

Art. 0830154N.C7R

PCS. 36

€ tbc

4 / 4 / 48



	4 x Ø 21 cm		4 x Ø 25 cm
	4 x Ø 20 cm		4 x 30 cl
	4 x 20 cl		16 pcs

# DEEP SEA

## ALLROUND



**Piatto piano ø 25 cm**

Art. 0830025N.C7R

€ tbc

12 / 36 / -



**Piatto fondo ø 21 cm**

Art. 0830026N.C7R

€ tbc

12 / 36 / -



**Piatto dessert ø 20 cm**

Art. 0830027N.C7R

€ tbc

12 / 48 / -



**Tazzone 30 cl**

Art. 0830051N.C06

€ tbc

12 / 36 / -



**Tazzina espresso 10 cl**

Art. 0830055N.C06

€ tbc

6 / 48 / -



**Tazza con piattino 25 cl**

Art. 0830022N.C06

€ tbc

6 / 36 / -



**Scodella ø 15 cm**

Art. 0830043N.C7R

€ tbc

12 / 48 / -



**Insalatiera ø 23,5 cm**

Art. 0830030N.C7R

€ tbc

4 / 24 / -



**Bicchiere 30 cl**

Art. 0830185N.C7R

€ tbc

6 / 12 / -



**Posate insalata**

Art. 0830039N.C06

€ tbc

6 / 48 / -



**Portauovo**

Art. 0830032N.C7R

€ tbc

12 / 72 / -



**Burriera 13,5 x 9,5 x H6,5 cm**

Art. 0830099N.C06

€ tbc

12 / 24 / -



**Portacenerie**

Art. 0830071N.C06

€ tbc

6 / 48 / -



**Tagliere/vassoio 36x24 cm**

Art. 0830056N.C06

€ tbc

6 / 12 / -



**Cestino pane 24x24 cm**

Art. 0830060N.C06

€ tbc

12 / 36 / -





# COSMIC

## ALLROUND



### TÊTE-Â-TÊTE COSMIC





Art. 0830143N.C8A

PCS. 8

€ tbc

6 / 6 / -



	2 x Ø 21 cm		2 x Ø 25 cm
	2 x Ø 15 cm		2 x 30 cl

### MIDDAY COSMIC



Art. 0830148N.C8A

PCS. 12

€ tbc

4 / 4 / 88



	4 x Ø 15 cm		4 x Ø 25 cm
	4 x Ø 20 cm		

### SET COSMIC





Art. 0830160N.C8A

PCS. 16

€ tbc

4 / 4 / 56



	4 x Ø 21 cm		4 x Ø 25 cm
	4 x Ø 20 cm		4 x 30 cl

### ALL INCLUSIVE COSMIC







Art. 0830154N.C8A

PCS. 36

€ tbc

4 / 4 / 48



	4 x Ø 21 cm		4 x Ø 25 cm
	4 x Ø 20 cm		4 x 30 cl
	4 x 20 cl		16 pcs

Piatto piano ø 25 cm

Art. 0830025N.C8A

€ tbc  
12 / 36 / -

Piatto fondo ø 21 cm

Art. 0830026N.C8A

€ tbc  
12 / 36 / -

Piatto dessert ø 20 cm

Art. 0830027N.C8A

€ tbc  
12 / 48 / -

Tazzone 30 cl

Art. 0830051N.C8A

€ tbc  
12 / 36 / -

Tazzina espresso 10 cl

Art. 0830055N.C8A

€ tbc  
6 / 48 / -

Tazzone 30 cl

Art. 0830035N.C8A

€ tbc  
12 / 36 / -

Scodella ø 15 cm

Art. 0830043N.C8A

€ tbc  
12 / 48 / -

Insalatiera ø 23,5 cm

Art. 0830030N.C8A

€ tbc  
4 / 24 / -

Bicchieri 30 cl

Art. 0830185N.C8A

€ tbc  
6 / 12 / -

Posate insalata

Art. 0830039N.C8A

€ tbc  
6 / 48 / -

Portauovo

Art. 0830032N.C8A

€ tbc  
12 / 72 / -

Burriera

Art. 0830059N.C8A

€ tbc  
12 / 24 / -

Lattiera 30 cl

Art. 0830058N.C8A

€ tbc  
12 / 24 / -

Tagliere 23,5x14,5 cm

Art. 0830021N.C8A

€ tbc  
12 / 48 / -

Vassoio ø 30 cm

Art. 0830080N.C8A

€ tbc  
4 / 8 / -



# SERENADE

## ALLROUND



**Piatto piano ø 25 cm**

Art. 0830025N.C6A

€ tbc

12 / 36 / -



**Piatto fondo ø 21 cm**

Art. 0830026N.C6A

€ tbc

12 / 36 / -



**Piatto dessert ø 20 cm**

Art. 0830027N.C6A

€ tbc

12 / 48 / -



**Tazzone 30 cl**

Art. 0830035N.C6A

€ tbc

12 / 36 / -



**Portauovo**

Art. 0830032N.C6A

€ tbc

12 / 72 / -



**Burriera**

Art. 0830059N.C6A

€ tbc

12 / 24 / -



**MELANGE**

Art. 0830006N

€ tbc

22,3 x ø 5 cm 12 / 24 / -



**Bicchieri 40 cl**

Art. 0830187S.C6A

€ tbc

6 / 12 / -



POLYCARBONATE  
HIGH QUALITY DRINKWARE



## TÊTE-Â-TÊTE SERENADE

Art. 0830143N.C6A

€ tbc

6 / 6 / -

PCS. 8



## MIDDAY SERENADE

Art. 0830148N.C6A

€ tbc

4 / 4 / 88

PCS. 12



## SET WINEGLASS THANGO BLACK

Art. 0830184N.C03

€ tbc

2 / 6 / -

60 cl

PACK 4X

	2 x Ø 21 cm		2 x Ø 25 cm
	2 x Ø 15 cm		2 x 30 cl

	4 x Ø 15 cm		4 x Ø 25 cm
	4 x Ø 20 cm		4 x 30 cl

**Tazzone 30 cl**

Art. 0830051N.C03

€ tbc

12 / 36 / -



**Tazza con piattino 25 cl**

Art. 0830022N.C03

€ tbc

6 / 36 / -



## SET SERENADE

Art. 0830160N.C6A

€ tbc

4 / 4 / 56

PCS. 16



## ALL INCLUSIVE SERENADE

Art. 0830154N.C6A

€ tbc

4 / 4 / 48

PCS. 36



**Tazzina espresso 10 cl**

Art. 0830055N.C03

€ tbc

6 / 48 / -



**Scodella ø 15 cm**

Art. 0830043N.C03

€ tbc

12 / 48 / -



**Portacenere**

Art. 0830071N.C03

€ tbc

6 / 48 / -



**Cestino pane 24x24 cm**

Art. 0830060N.C03

€ tbc

12 / 36 / -



	4 x Ø 21 cm		4 x Ø 25 cm
	4 x Ø 20 cm		4 x 30 cl

	4 x Ø 21 cm		4 x Ø 25 cm
	4 x Ø 20 cm		4 x 30 cl

	4 x 20 cl		16 pcs
--	-----------	--	--------



# PRALIN

## ALLROUND



### Piatto piano ø 25 cm

Art. 0830025N.C6X

€ tbc  
12 / 36 / -

### Piatto fondo ø 21 cm

Art. 0830026N.C6X

€ tbc  
12 / 36 / -

### Piatto dessert ø 20 cm

Art. 0830027N.C6X

€ tbc  
12 / 48 / -

### Tazzone 30 cl

Art. 0830035N.C6X

€ tbc  
12 / 36 / -

### Portauovo

Art. 0830032N.C6X

€ tbc  
12 / 72 / -

### Scodella ø 15 cm

Art. 0830043N.C6X

€ tbc  
12 / 48 / -

### Bicchiere 30 cl

Art. 0830185N.C6X

€ tbc  
6 / 12 / -

### OLIAC

Art. 0830000N.C4N

 2x 130 ml
€ tbc  
12 / 12 / -

## SET WINEGLASS THANGO BLACK & WHITE

Art. 0830184N.C4N

€ tbc  
2 / 6 / -
 60 cl

PACK 2X

### Lattiera 30 cl

Art. 0830058N.C03

€ tbc  
12 / 24 / -

### Contenitore ø 12x14,5 cm

Art. 0830040N.C03

€ tbc  
4 / 48 / -

### Posate insalata

Art. 0830039N.C03

€ tbc  
6 / 48 / -

### Burriera 13,5 x 9,5 x H6,5 cm

Art. 0830099N.C03

€ tbc  
12 / 24 / -

### Tagliere/vassoio 36x24 cm

Art. 0830056N.C03

€ tbc  
6 / 12 / -

## TÊTE-Â-TÊTE PRALIN

Art. 0830143N.C6X

€ tbc  
6 / 6 / -

PCS. 8

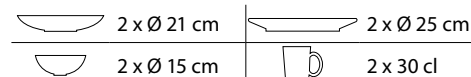

## MIDDAY PRALIN

Art. 0830148N.C6X

€ tbc  
4 / 4 / 88

PCS. 12

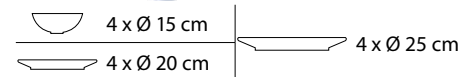

## SET PRALIN

Art. 0830160N.C6X

€ tbc  
4 / 4 / 56

PCS. 16

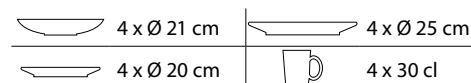

## ALL INCLUSIVE PRALIN

Art. 0830154N.C6X

€ tbc  
4 / 4 / 48

PCS. 36

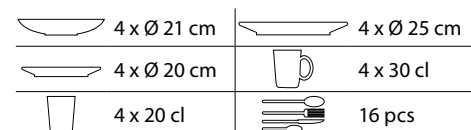



# KHADI

## SQUARE



### Piatto piano 26x26 cm

Art. 0830025N.C9T € tbc  
12 / 36 / -



### Piatto fondo 23x23 cm

Art. 0830026N.C9T € tbc  
12 / 36 / -



### Piatto dessert 20x20 cm

Art. 0830027N.C9T € tbc  
12 / 48 / -



### Bicchiere 30 cl

Art. 0830185N.C9T € tbc  
6 / 12 / -



### Scodella 15x15 cm

Art. 0830098N.C9T € tbc  
12 / 48 / -



### Insalatiera 25x25 cm

Art. 0830034N.C9T € tbc  
4 / 24 / -



### Tazzone 30 cl

Art. 0830051N.C1C € tbc  
12 / 36 / -



### Tazzina espresso 10 cl

Art. 0830055N.C1C € tbc  
6 / 48 / -



### Tazzina espresso 10 cl

Art. 0830055N.C06 € tbc  
6 / 48 / -



### Portauovo

Art. 0830032N.C9T € tbc  
12 / 72 / -



### Lattiera 30 cl

Art. 0830058N.C1C € tbc  
12 / 24 / -



### Tazza con piattino 25 cl

Art. 0830022N.C06 € tbc  
6 / 36 / -



### Tagliere/vassoio 36x24 cm

Art. 0830056N.C06 € tbc  
6 / 12 / -



### Burriera 13,5 x 9,5 x H6,5 cm

Art. 0830099N.C06 € tbc  
12 / 24 / -



### Portacenere

Art. 0830071N.C06 € tbc  
6 / 48 / -



## MIDDAY KHADI'

Art. 0830148N.C9T € tbc  
PCS. 12 4 / 4 / 88

## SET KHADI'

Art. 0830161N.C9T € tbc  
PCS. 16 4 / 4 / 56

## ALL INCLUSIVE KHADI'

Art. 0830154N.C9T € tbc  
PCS. 36 4 / 4 / 48



4x 15 x 15 cm  
4x 20 x 20 cm  
4x 26 x 26 cm



4x 23 x 23 cm  
4x 20 x 20 cm  
4x 26 x 26 cm  
4 x 30 cl



4x 23 x 23 cm  
4x 20 x 20 cm  
4 x 20 cl  
4x 26 x 26 cm  
4 x 30 cl  
16 pcs



# PANAREA

## SQUARE

### Piatto piano 25x25 cm

Art. 0830320N.C2X

€ tbc

24 / 24 / -



### Piatto fondo 23x23 cm

Art. 0830310N.C2X

€ tbc

24 / 24 / -



### Piatto dessert 20x20 cm

Art. 0830330N.C2X

€ tbc

24 / 24 / -



### Scodella 15x15 cm

Art. 0830350N.C2X

€ tbc

24 / 24 / -



### Tazzone 35 cl

Art. 0830140N.C2X

€ tbc

24 / 24 / -



### SET PANAREA

Art. 0830161N.C2X

PCS. 16

€ tbc

4 / 4 / 56

	4x 23 x 23 cm
	4x 20 x 20 cm
	4x 25 x 25 cm
	4 x 35 cl

### ALL INCLUSIVE PANAREA

Art. 0830154N.C2X

PCS. 36

€ tbc

4 / 4 / 48

	4x 23 x 23 cm
	4x 20 x 20 cm
	4x 25 x 25 cm
	4 x 35 cl
	4 x 20 cl
	16 pcs

### Piatto piano 25x25 cm

Art. 0830320N.C5L

€ tbc

24 / 24 / -



### Piatto fondo 23x23 cm

Art. 0830310N.C5L

€ tbc

24 / 24 / -



### Piatto dessert 20x20 cm

Art. 0830330N.C5L

€ tbc

24 / 24 / -



### Scodella 15x15 cm

Art. 0830350N.C5L

€ tbc

24 / 24 / -



### Tazzone 35 cl

Art. 0830140N.C5L

€ tbc

24 / 24 / -



# ENIGMA

## SQUARE

### SET ENIGMA

Art. 0830161N.C5L

PCS. 16

€ tbc

4 / 4 / 56

	4x 23 x 23 cm
	4x 20 x 20 cm
	4x 25 x 25 cm
	4 x 35 cl

### ALL INCLUSIVE ENIGMA

Art. 0830154N.C5L

PCS. 36

€ tbc

4 / 4 / 48

	4x 23 x 23 cm
	4x 20 x 20 cm
	4x 25 x 25 cm
	4 x 35 cl
	4 x 20 cl
	16 pcs



# SEQUOIA

## FLASH



**Piatto piano ø 26 cm**

Art. 0830025N.C2A

€ tbc  
12 / 36 / -



**Scodella ø 15 cm**

Art. 0830043N.C2A

€ tbc  
12 / 48 / -



**Piatto da portata 35x24 cm**

Art. 0830053N.C2A

€ tbc  
4 / 12 / -



**Piatto fondo ø 21 cm**

Art. 0830026N.C2A

€ tbc  
12 / 36 / -



**Insalatiera ø 24,5 cm**

Art. 0830030N.C2A

€ tbc  
4 / 24 / -



**Portauovo**

Art. 0830032N.C2A

€ tbc  
12 / 72 / -



**Piatto dessert ø 20 cm**

Art. 0830027N.C2A

€ tbc  
12 / 48 / -



### MIDDAY SEQUOIA

Art. 0830148N.C2A

PCS. 12

€ tbc  
4 / 4 / -



### SET SEQUOIA

Art. 0830160N.C2A

PCS. 16

€ tbc  
4 / 4 / -



**Tazzone 30 cl**

Art. 0830035N.C2A

€ tbc  
12 / 36 / -

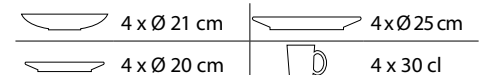
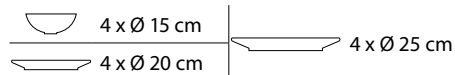



# BREEZE

## FLASH



Info p. 289



**Piatto piano ø 26 cm**

Art. 0830025N.C3B

€ tbc  
12 / 24 / -



**Scodella ø 15 cm**

Art. 0830043N.C3B

€ tbc  
12 / 48 / -



**Piatto fondo ø 19 cm**

Art. 0830026N.C3B

€ tbc  
12 / 36 / -



**Insalatiera ø 25 cm**

Art. 0830030N.C3B

€ tbc  
4 / 16 / -



**Portauovo**

Art. 0830032N.C3B

€ tbc  
12 / 72 / -



**Piatto dessert ø 22 cm**

Art. 0830027N.C3B

€ tbc  
12 / 48 / -



### MIDDAY BREEZE

Art. 0830148N.C3B

PCS. 12

€ tbc  
4 / 4 / -

### SET BREEZE

Art. 0830160N.C3B

PCS. 16

€ tbc  
4 / 4 / -

**Tazzone 30 cl**

Art. 0830077N.C3B

€ tbc  
12 / 36 / -

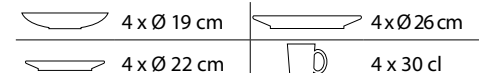
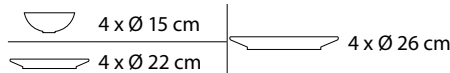



# ASTRALYS

## FLASH



# BLUEBAY

## FLASH





### MIDDAY ASTRALYS

Art. 0830148N.C55

PCS. 12

€ tbc  
4/4/88

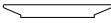

-  4 x Ø 15 cm
-  4 x Ø 20 cm
-  4 x Ø 25 cm



### MIDDAY BLUEBAY

Art. 0830148N.C6T

PCS. 12

€ tbc  
4/4/88

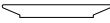

-  4 x Ø 13,5 cm
-  4 x Ø 21 cm
-  4 x Ø 25 cm





### SET ASTRALYS

Art. 0830160N.C55

PCS. 16

€ tbc  
4/4/56



-  4 x Ø 22 cm
-  4 x Ø 20 cm
-  4 x Ø 25 cm
-  4 x 30 cl





### SET BLUEBAY

Art. 0830160N.C6T

PCS. 16

€ tbc  
4/4/56



-  4 x Ø 21 cm
-  4 x Ø 20 cm
-  4 x Ø 25 cm
-  4 x 30 cl







### ALL INCLUSIVE ASTRALYS

Art. 0830154N.C55

PCS. 36

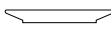
€ tbc  
4/4/48



-  4 x Ø 22 cm
-  4 x Ø 20 cm
-  4 x Ø 25 cm
-  4 x 20 cl
-  4 x 30 cl
-  16 pcs







### ALL INCLUSIVE BLUEBAY

Art. 0830154N.C6T

PCS. 36

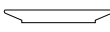
€ tbc  
4/4/48



-  4 x Ø 21 cm
-  4 x Ø 20 cm
-  4 x Ø 25 cm
-  4 x 20 cl
-  4 x 30 cl
-  16 pcs







**SET ESPRIT**

Art. 0830160N.C5B

PCS. 16

€ tbc  
4 / 4 / 56







	4 x Ø 21 cm
	4 x Ø 20 cm
	4 x Ø 25 cm
	4 x 30 cl

**ALL INCLUSIVE ESPRIT**

Art. 0830154N.C5B

PCS. 36

€ tbc  
4 / 4 / 48





	4 x Ø 21 cm		4 x Ø 25 cm
	4 x Ø 20 cm		4 x 30 cl
	4 x 20 cl		16 pcs

**SET TULIP**

Art. 0830160N.C4E

PCS. 16

€ tbc  
4 / 4 / 56







	4 x Ø 21 cm
	4 x Ø 20 cm
	4 x Ø 25 cm
	4 x 30 cl

**ALL INCLUSIVE TULIP**

Art. 0830154N.C4E

PCS. 36

€ tbc  
4 / 4 / 48

	4 x Ø 21 cm		4 x Ø 25 cm
	4 x Ø 20 cm		4 x 30 cl
	4 x 20 cl		16 pcs

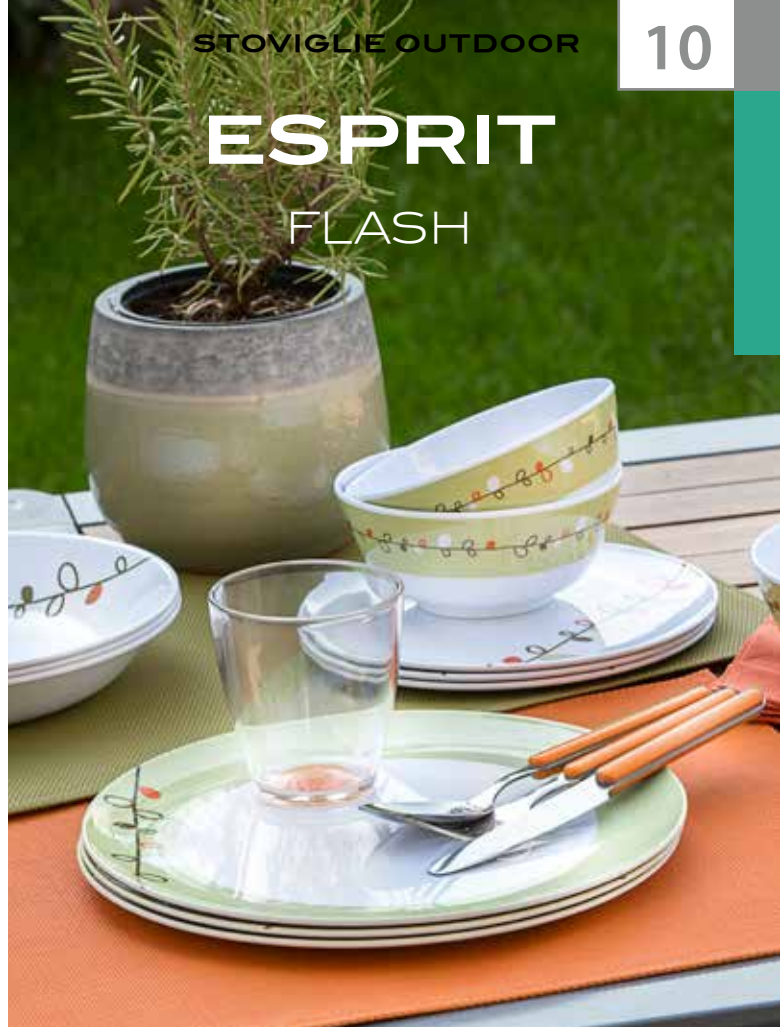
**ESPRIT**  
FLASH**TULIP**  
FLASH



# BBGRILL

LIVING



**Piatto piano 31x27 cm**  
Art. 0830045N.C5R € tbc  
12 / 24 / -



**Appetizer 3x ø11cm / 40cm**  
Art. 0830041N.C5R € tbc  
4 / 16 / -



**Scodella 16x14 cm**  
Art. 0830047N.C5R € tbc  
12 / 24 / -



**Insalatiera 31x24,5 cm**  
Art. 0830046N.C5R € tbc  
6 / 12 / -

# SOUP BOWL

LIVING



**Set zuppiera 1x 55 cl / 1x 24x18 cm**  
Art. 0830049N.C5T € tbc  
6 / 12 / 96



**Set zuppiera 1x 55 cl / 1x 24x18 cm**  
Art. 0830049N.C3S € tbc  
6 / 12 / -



**Set zuppiera 1x 55 cl / 1x 24x18 cm**  
Art. 0830049N.C4P € tbc  
6 / 12 / -



**Set zuppiera 1x 55 cl / 1x 24x18 cm**  
Art. 0830049N.C4X € tbc  
6 / 12 / -



100% Melamine

## APPETIZER

Art. 0830042N.C06  
35,5 x 8,5 x H5,5 cm



## CHEESE SET

Art. 0830134N

€ tbc  
4 / 16 / -

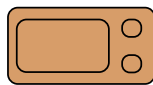

40 x 20,5 cm



25 x 15,5 cm  
**Slate**

9 x 9 x H5 cm  
100% Melamine



## GREENKICK

Art. 0830044N.C06

Ø 25 cm

€ tbc  
6 / 6 / -



Art. 0830044N.C4P



Art. 0830044N.C1M





# PASTA & SALAD

LIVING



## PASTA & SALAD SET

Art. 0830132N

PCS. 5

€ tbc  
4 / 4 / 48

1 x Ø 29,5 cm  
4 x Ø 20 cm

# PIZZA

LIVING



## SET PIZZA

Art. 0830131N

PCS. 2

€ tbc  
6 / 6 / 48

Ø 37,5 cm



## BREAD BOARD

Art. 0830056N.C06

36 x 24 cm

€ tbc  
6 / 12 / -

## BREAD BASKET

Art. 0830060N.C06

24 x 24 cm

€ tbc  
12 / 36 / -

## BUTTER BOX

Art. 0830099N.C06

13,5 x 9,5 x H6,5 cm

€ tbc  
12 / 24 / -



# ICE CREAM COLLECTION

## SET ICE CREAM CUP

Art. 0830037N.C9N

Ø 12 cm

PCS. 4

€ tbc  
6 / 12 / -



Set di 4 ciotole per gelato in melamina di alta qualità. Con cucchiaini.

## SET ICE CREAM BOWL

Art. 0830036N.C9N

Ø 11 cm

PCS. 4

€ tbc  
6 / 12 / -



Set di 4 ciotole per gelato in melamina di alta qualità. Con cucchiaini.

## ICE CREAM SCOOPER

Art. 0830038N.C9N

€ tbc  
12 / 48 / -



Paletta per gelato in melamina di alta qualità.



kids  
collection



1x 220 ml  
1X | 1x 20 x 23 cm

## Silicon Soft Touch



## JUNGLE PARADE 6M+

Art. 0830072N

PCS. 3

€ tbc  
6 / 12 / -



100%  
silicone

## AROUND THE WORLD 6M+

Art. 0830076N

PCS. 3

€ tbc  
6 / 12 / -





100%  
silicone



# KIDS

## COLLECTION

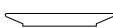

	1x Ø 16 cm		1x Ø 22 cm
	2 pcs		1x 20 cl

### BUTTERFLY 3+

Art. 0830073N

PCS. 5

€ tbc  
6/12/-

### FARM 3+

Art. 0830074N

PCS. 5

€ tbc  
6/12/96

### TIME TO TRAVEL 3+

Art. 0830077N

PCS. 5

€ tbc  
6/12/-

### MOLLY 3+

Art. 0830078N

PCS. 5

€ tbc  
6/12/-

### JACK 3+

Art. 0830079N

PCS. 5

€ tbc  
6/12/96

### LET'S GO ADVENTURE 3+

Art. 0830070N

PCS. 5

€ tbc  
6/12/96



## EASTWOOD

Art. 0830115N

PCS. 12

€ tbc  
4 / 4 / 48

**Classico set stoviglie da 12 pezzi. Realizzato in acciaio smaltato con anello di protezione in acciaio inox.**

### CARATTERISTICHE:

- Acciaio di alta qualità con rivestimento in smalto
- Superficie antiruggine
- Robuste, resistenti e leggere
- Perfette per le attività all'aria aperta
- Igieniche e facili da pulire

	4x 50 cl
	4 x Ø 18 cm
	4 x Ø 24 cm



## BIWAK

Art. 0832043N

€ tbc  
10 / 100 / -

100 g



Set posate outdoor in acciaio inox di ottima qualità. Il set comprende coltello, forchetta e cucchiaio collegati mediante un anello apribile.



## GLUG

Art. 0830007N

€ tbc  
6 / 60 / -

105 g

300 ml



Classico tazzone realizzato in acciaio inox.

## LEGEND KARAMUG

Art. 0820068N

€ tbc  
12 / 48 / -

Ø 7 x H8 cm

113 g

200 ml



Tazzone termoisolante a doppia parete realizzato in acciaio inox.



1

2



Melamineware



**INOX**  
Stainless Steel

## HUNGRY

Art. 0830110N.C30

€ tbc  
12 / 12 / -



Ø 17,5/14 x 6 cm

## HUNGRY XL

Art. 0830111N.C30

€ tbc  
12 / 12 / -



Ø 22/18,5 x 6 cm

Ciotola per cani realizzata in resistente melamina con inserto in acciaio inox e pratico anello antiscivolo. Ideale per l'amico più fedele del camperista.



**CUTRAY**

Art. 0420010N

€ tbc  
15 / 75 / -

✂ 33,5 x 24,5 x H4,5 cm

Portaposate in materiale plastico.

**MANTIS**

Art. 0420008N

€ tbc  
10 / 50 / -

✂ 23,5/39,5 x 31,5 x H6 cm

Portaposate da cassetto. Regolabile, a 7 scomparti, con inserto superiore riposizionabile.

**CHOPPER**

Art. 0420002N

€ tbc  
12 / 48 / -

✂ 32 x 23 cm

Tagliere in bambù utilizzabile su entrambi i lati.

**DELICIA**

Art. 0832005N

€ tbc  
12 / 12 / -

COLORS C43 C06 C03 C30

✂ Syntex

✂ 30 x 45 cm

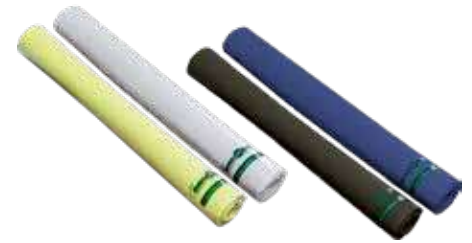

Tovaglietta decorativa, dà un tocco di colore alla tavola. Pratica, molto resistente e di facile pulizia.





## DELICE

Art. 0832016N

COLORS C06 C10 C03 C11 C02 C34 C8A C30

Set posate composto da 16 pezzi. Esecuzione molto solida con anima in metallo.

€ tbc  
5 / 20 / -



## DELICE WOOD

Art. 0832016N.C25

NEW  
2023



€ tbc  
5 / 20 / -



## SAVOR

Art. 0832018N.C22

€ tbc  
5 / 20 / -

Set posate in acciaio inox composto da 16 pezzi. Manico in materiale plastico con foro per appendere.



NEW  
2023

## AMYLA

Art. 0832008N.C06

€ tbc  
5 / 20 / -

Set posate dal design moderno, composto da 16 pezzi. Esecuzione molto solida con anima in metallo.



## PARTY

Art. 0832015N

€ tbc  
5 / 20 / -

COLORS C06 C30

Posate in acciaio inox anti-ruggine con manico anti-scivolo. Set da 16 pezzi.



NEW  
2023

## PATIS

Art. 0832009N.C25

€ tbc  
5 / 20 / -

Set posate composto da 16 pezzi.





NEW  
2023



### SAPORA

Art. 0832011N

€ tbc  
5 / 20 / -

COLORS C22 C48 C1C

NEW  
2023



### SAPORA JUNIOR

Art. 0832012N.C22

€ tbc  
5 / 20 / -

PCS. 3

Set posate composto da 16 pezzi. Esecuzione molto solida con anima in metallo.



NEW  
2023

### JOIA

Art. 0832017N

€ tbc  
5 / 20 / -

Set posate composto da 16 pezzi in acciaio inossidabile.



NEW  
2023

### ROCK SLIM

Art. 0832010N

€ tbc  
5 / 20 / -

Elegante set posate composto da 16 pezzi, con profilo sottile.



# CUVÉE

## COLLECTION



Il policarbonato è un materiale trasparente (polimero) che riunisce molte caratteristiche utili di metallo, vetro e materiali sintetici: altissima resistenza agli urti • anti-graffio • alta resistenza alla temperatura • ottime caratteristiche ottiche (trasparenza) • autoestinguente.

### WATER GLASS

Art. 0830200N.C71

€ tbc  
2 / 12 / -

30 cl

PACK 2X



### WHITE WINEGLASS

Art. 0830171N.C71

€ tbc  
2 / 6 / -

30 cl

PACK 2X



### WINEGLASS

Art. 0830191N.C71

€ tbc  
2 / 6 / -

**tritan™**  
from eastman

45 cl

PACK 2X



### R&W WINEGLASS

Art. 0830166N.C71

€ tbc  
2 / 6 / 90

69 cl

PACK 2X



### RED WINEGLASS

Art. 0830184N.C71

€ tbc  
2 / 6 / -

60 cl

PACK 2X



### PROSECCO GLASS

Art. 0830205N.C71

€ tbc  
2 / 8 / 96

25 cl

PACK 2X



WATER GLASS



WHITE WINEGLASS

**tritan™**  
from eastman

WINEGLASS



R&W WINEGLASS

RED WINEGLASS



PROSECCO GLASS



Il materiale plastico Tritan è un'alternativa equivalente al polycarbonato ampiamente utilizzato. Tritan è stato sviluppato specificamente come alternativa senza BPA al polycarbonato, noto per contenere quantità minori di BPA. Perfettamente adatto per la produzione di bicchieri in plastica in-frangibili che assomigliano esattamente a bicchieri di vetro, bicchieri di plastica, bicchieri da vino o eleganti calici.

#### CARATTERISTICHE SPECIALI DI TRITAN

- I prodotti Tritan sono trasparenti, durevoli e sicuri
- Tritan non contiene BPA, BPS o altri bisfenoli
- Tritan ha una resistenza alla rottura molto maggiore rispetto ad altre materie plastiche e vetro
- Tritan non si ammacca
- Tritan ha un look ed un feel simile al vetro
- Il Tritan non diventa nebuloso o torbido dopo il lavaggio
- Tritan può essere sagomato come desiderato (in produzione)
- Tritan è più leggero del vetro
- Tritan è sicuro per i bambini
- Tritan è in grado di resistere a temperature fino a 85°C

# RISERVA

## COLLECTION

**tritan™**  
from eastman

### WATER GLASS

Art. 0830216N.C71

€ tbc

6 / 12 / -

 30 cl

PACK 2X



### WINEGLASS

Art. 0830218N.C71

€ tbc

2 / 6 / -

 45 cl

PACK 2X



### WHITE WINEGLASS

Art. 0830219N.C71

€ tbc

2 / 6 / -

 42 cl

PACK 2X



### R&W WINEGLASS

Art. 0830213N.C71

€ tbc

2 / 6 / -

 58 cl

PACK 2X



### RED WINEGLASS

Art. 0830220N.C71

€ tbc

2 / 6 / 72

 72 cl

PACK 2X



### PROSECCO GLASS

Art. 0830217N.C71

€ tbc

2 / 6 / -

 25 cl

PACK 2X



Freezer



WATER GLASS



WINEGLASS

WHITE  
WINEGLASS

R&amp;W WINEGLASS

RED  
WINEGLASS

PROSECCO GLASS



# AMADÉ

## COLLECTION



WATER GLASS



R&W WINEGLASS



WHITE WINEGLASS



WINEGLASS

### SET WATERGLASS

Art. 0830221N.C71

€ tbc  
2/6/-

45 cl

PACK 2X



### SET WINEGLASS

Art. 0830223N.C71

€ tbc  
2/6/-

60 cl

PACK 2X



**tritan™**  
from eastman

### SET R&W WINEGLASS

Art. 0830224N.C71

€ tbc  
2/6/-

58 cl

PACK 2X



### SET WHITE WINEGLASS

Art. 0830226N.C71

€ tbc  
2/6/-

42 cl

PACK 2X



# CORALUX

### SET WINEGLASS

Art. 0830231N.C25

€ tbc  
2/6/-

40 cl

PACK 2X

### SET WATERGLASS

Art. 0830230N.C25

€ tbc  
2/6/-

35 cl

PACK 2X



### SET BOWLS

Art. 0830232N.C25

€ tbc  
2/6/-

80 cl

PACK 2X



**SET WINEGLASS SPHERICA**

Art. 0830225N.C71

€ tbc

2 / 6 / 72

 60 cl

PACK 2X

  
 from eastman
**SET WATERGLASS BLACKSATIN**

Art. 0830183N.C1M

€ tbc

2 / 6 / -

 35 cl

PACK 2X

**SET WATERGLASS BROWNSATIN**

Art. 0830183N.C02

€ tbc

2 / 6 / -

 35 cl

PACK 2X

**SET WINEGLASS BLACKSATIN**

Art. 0830184N.C1M

€ tbc

2 / 6 / -

 60 cl

PACK 2X

**SET WINEGLASS BROWNSATIN**

Art. 0830184N.C02

€ tbc

2 / 6 / -

 60 cl

PACK 2X

**SET WATER GLASS GREY**

Art. 0830200N.C06

€ tbc

2 / 12 / -

 30 cl

PACK 2X

**SET WINEGLASS THANGO GREY**

Art. 0830184N.C06

€ tbc

2 / 6 / -

 60 cl

PACK 2X

**SET WINEGLASS THANGO BLACK**

Art. 0830184N.C03

€ tbc

2 / 6 / -

 60 cl

PACK 2X

**SET WINEGLASS THANGO BLACK & WHITE**

Art. 0830184N.C4N

€ tbc

2 / 6 / -

 60 cl

PACK 2X





# BEER

## COLLECTION

SCRATCH RESISTANT  
HIGH IMPACT RESISTANCE  
**POLYCARBONATE**  
HIGH QUALITY DRINKWARE  
PERFECTLY TRANSPARENT  
LIGHTWEIGHT

**tritan™**  
from eastman



PINT

TULIP

SPECIAL

PILSNER

MUNICH

CLASSIC

### SET BEERGLASS PINT

Art. 0830210N.C71

€ tbc  
6 / 12 / -



57 cl

PACK 2X

### SET BEERGLASS TULIP

Art. 0830211N.C71

€ tbc  
12 / 12 / -



46 cl

PACK 2X

**tritan™**  
from eastman

### SET BEERGLASS SPECIAL

Art. 0830173N.C71

€ tbc  
6 / 12 / -



50 cl

PACK 2X

### SET BEERGLASS PILSNER

Art. 0830209N.C71

€ tbc  
8 / 8 / 96



44 cl

PACK 2X

### SET BEERGLASS MU- NICH

Art. 0830196N.C71

€ tbc  
2 / 6 / -



55 cl

PACK 2X

### SET BEERGLASS CLASSIC

Art. 0830174N.C71

€ tbc  
2 / 6 / -



60 cl

PACK 2X



**PC-CARAFFE**

Art. 0830193N

€ tbc  
4 / 12 / - 520 mlCOLORS  C34  C00**PC-CARAFFE**

Art. 0830172N

€ tbc  
4 / 12 / - 1000 mlCOLORS  C34  C00**VIAL**

Art. 0830203N.C71

€ tbc  
2 / 12 / - 900 ml**COGNAC  
WHISKY  
GRAPS  
COLLECTION****SET COGNAC**

Art. 0830202N.C71

€ tbc  
6 / 6 / - 43 cl

PACK 2X

**SET GRAPS**

Art. 0830180N.C71

€ tbc  
6 / 12 / - 30 ml

PACK 2X

**SET KAPTIM**

Art. 0830222N.C71

€ tbc  
6 / 6 / - 25 cl

PACK 2X



## BALOONS

Art. 0830212N.C9N

€ tbc  
6/6/-

✓ 35 cl

PACK 3X

ASSORTED



## BALOONS

Art. 0830182N

€ tbc  
6/6/-

✓ 35 cl

PACK 2X

COLO C30 C10 C34



## OXIGEN

Art. 0830208N.C9N

✓ 30 cl

PACK 4X



€ tbc  
6/6/-

## VINTAGE

Art. 0830195N

✓ 30 cl

PACK 4X



€ tbc  
6/6/-



## COOL CUBES

Art. 0826005N

€ tbc  
12/48/-

PACK 10X



Cubetti ghiaccio riutilizzabili in materiale plastico. Perfetti per raffreddare tutti i tipi di bevande.







Il SAN (Styrol-Acrylnitril) è un materiale plastico rigido e trasparente ad uso alimentare, adatto al lavaggio in lavastoviglie e quindi perfetto all'utilizzo in cucina.

**TAHITI**

Art. 0830181C.C9N

 20 cl

PACK 4X

 € tbc  
6 / 6 / -
**OCTOGLASS COLOR**

Art. 0830207N.C9N

 28 cl

PACK 4X

 € tbc  
6 / 12 / -
**MULTIGLASS COLOR**

Art. 0830192N.C9N

 30 cl

PACK 4X

 € tbc  
6 / 6 / -

ASSORTED

**MULTIGLASS COLOR**

Art. 0830188N

 30 cl

PACK 2X

 COLORS C30 C10 C34 C11

 € tbc  
6 / 6 / -
**WINEGLASS GLAMOUR**

Art. 0830184C.C1P

 60 cl

PACK 4X

 € tbc  
2 / 6 / 72



## WINEGLASS SAN 20

Art. 0830186N.C30

€ tbc  
6/24/-

✓ 20 cl



## OCTOGLASS BLUE

Art. 08302075.C30

€ tbc  
6/12/-

✓ 28 cl



## WINEGLASS EPOCH

Art. 0830206N.C71

€ tbc  
6/12/-

✓ 17 cl

PACK 2X



## SET OCTOGLASS

Art. 0830178N.C71

€ tbc  
4/4/-

✓ 28 cl

PACK 3X



## SET COCKTAIL HIGH

Art. 0830165N.C71

€ tbc  
6/6/-

✓ 40 cl

PACK 2X



Il policarbonato è un materiale trasparente (polimero) che riunisce molte caratteristiche utili di metallo, vetro e materiali sintetici: altissima resistenza agli urti • antigraffio • alta resistenza alla temperatura • ottime caratteristiche ottiche (trasparenza) • autoestinguente.

## DIAMOND

Art. 0830204N

€ tbc  
6/6/-

✓ 30 cl

PACK 4X





**ONDA & JAZZ WINEGLASS**

Art. 0830184C.C9N

✓ 60 cl

PACK 4X

€ tbc  
2 / 6 / 72**ONDA**

Art. 0830214N

✓ 300 ml

PACK 4X

€ tbc  
6 / 12 / -**JAZZ**

Art. 0830215N

✓ 305 ml

PACK 4X

€ tbc  
6 / 12 / -



# POPOTE COLLECTION

PFOAfree

ALUMINIUM

**NON-STICK**  
PTFE COATING



Ideati per impedire ai cibi di attaccarsi, naturalmente senza che sia necessaria l'aggiunta di condimenti grassi e quindi per una cottura più sana! Garantito senza PFOA.

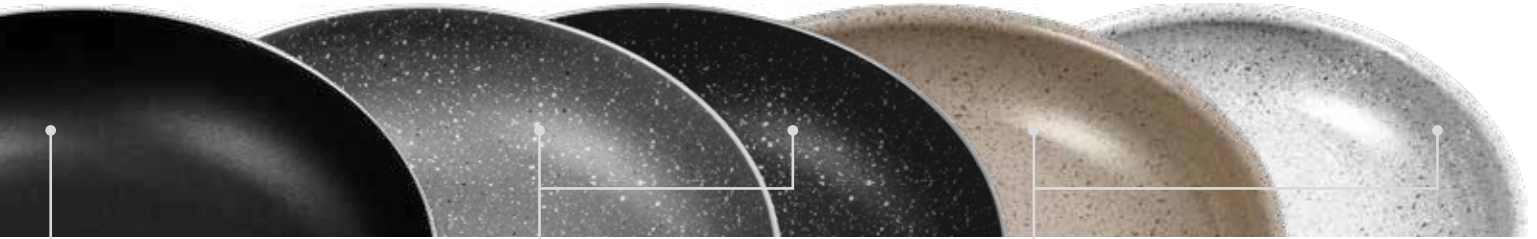

## Classic Black

Rivestimento antiaderente a lunga durata. Igienico, affidabile, resistente agli shock termici, alla corrosione e facile da lavare.

## Stone Rock

Speciale rivestimento effetto pietra rinforzato con minerali duri, ultrasensibile a graffi ed abrasioni.

## Ceramic

Innovativo rivestimento interno in ceramica antiaderente. Ottima resistenza alle alte temperature ed agli sbalzi termici, non sfoglia, lavabile in lavastoviglie.

### ALLUMINIO UN EFFICIENTE CONDUTTORE DI CALORE:

- è leggero • distribuisce il calore velocemente
  - fa risparmiare energia • regola meglio la temperatura.
- Rivestimento antiaderente.

### COTTURA E PULIZIA PIÙ FACILI:

- si riduce l'utilizzo di grassi durante la cottura • evita che il cibo si bruci
- comodo da pulire.



## HANDLES

PUSH SYSTEM CLAMP SYSTEM





# VACUBLOCK SYSTEM

## FUSION MAGNETIC, CAREZZA & PIRATE

**Il nuovo sistema Vacublock protegge le vostre pentole e padelle durante il viaggio e celebra la straordinaria creatività del nostro team di sviluppo nella creazione di soluzioni funzionali per veicoli ricreazionali e barche.**

- Facile e intuitivo da usare
- Blocca pentole e padelle mentre il veicolo è in movimento
- Elimina le possibilità di graffi della superficie antiaderente
- Elimina i rumori fastidiosi durante la guida

### COVERY TRIO Ø 20 / 18 / 16 CM

Art. 0806107N

€ tbc  
6 / 12 / -
 220 g

### COVERY TRIO Ø 22 / 20 / 18 CM

Art. 0806108N

€ tbc  
6 / 12 / -
 300 g

### COVERY TRIO Ø 24 / 22 / 20 CM

Art. 0806109N

€ tbc  
6 / 12 / -
 380 g

**Coperchio universale in vetro con bordo graduato in silicone adatto per pentole e padelle di diversi diametri.**

#### CARATTERISTICHE:

- Lavabile in lavastoviglie
- Foro per la compensazione della pressione
- Maniglia pieghevole salvaspazio
- Compatibile con il sistema VacuBlock





### COVERY Ø 24

Art. 0806103N

€ tbc  
6 / 12 / -
 400 g

### COVERY Ø 22

Art. 0806102N

€ tbc  
6 / 12 / -
 340 g

### COVERY Ø 20

Art. 0806101N

€ tbc  
6 / 12 / -
 260 g

**Coperchio in vetro con bordo di protezione antirumore in silicone dotato di apertura colapasta e fessura per fissaggio della pinza prendi pentole.**

#### CARATTERISTICHE:

- Bordo in silicone
- Lavabile in lavastoviglie
- Valvola di sfiato
- Maniglia pieghevole salvaspazio





# PIRATE

## STONE ROCK

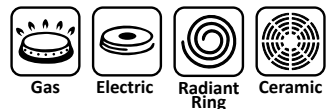

multiple  
layer  
coating



### PIRATE 6+1 Ø 18

Art. 0806092N

2,1 kg

€ tbc  
4 / 4 / 72

Ø 18 cm 3,3 l	Ø 16 cm 1,6 l	Ø 18 cm 1,3 l	Ø 18 cm	Ø 16 cm	1X	1x	



### PIRATE 7+1 Ø 20

Art. 0806093N

2,65 kg

€ tbc  
4 / 4 / 60

Ø 20 cm 4 l	Ø 20 cm	Ø 16 cm 1,6 l	Ø 20 cm 1,5 l	Ø 18 cm 1 l	Ø 18 cm	1X	1x



### PIRATE 7+1 Ø 22

Art. 0806094N

3,18 kg

€ tbc  
4 / 4 / 48

Ø 22 cm 5,3 l	Ø 22 cm	Ø 22 cm 1,8 l	Ø 18 cm 2 l	Ø 22 cm	Ø 18 cm	1X	1x



### PIRATE 9+1 Ø 24

Art. 0806095N

3,9 kg

€ tbc  
4 / 4 / 48

Ø 24 cm 6 l	Ø 22 cm	Ø 20 cm 2,5 l	Ø 16 cm 1,5 l	Ø 24 cm 2,2 l	Ø 20 cm 1,5 l	Ø 24 cm	Ø 20 cm	1X	1x





**PIRATE MEPO BOX 16+9**

Art. 0806086N

€ tbc  
1/2/-

8 kg



Ø 22 cm 5 l	Ø 18 cm 1 l	Ø 20 cm 1,7 l	Ø 22 cm 2 l	Ø 22 cm	Ø 18 cm	1X	1X

1x

31 x 54 x H27,5 cm



**Melamineware**

	4 x Ø 21 cm		4 x Ø 25 cm
	4 x Ø 15 cm		4 x 44 cl

**PIRATE PAN 3**

Art. 0806089N

1,20 kg

€ tbc  
6/12/-



Ø 28 cm



Ø 22 cm

**PIRATE POT 5**

Art. 0806088N

1,90 kg

€ tbc  
6/12/48



Ø 24 cm

Ø 20 cm

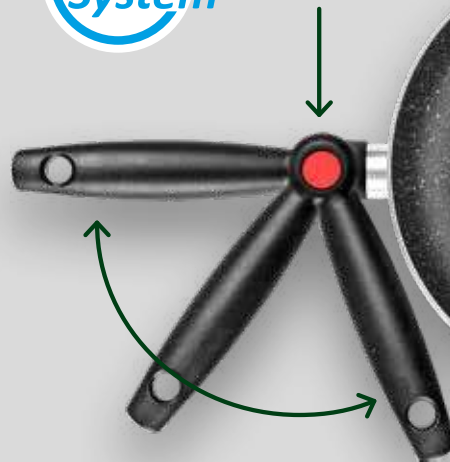

**PIRATE PAN 24**

Art. 0806098N

0,55 kg

Ø 24 cm

€ tbc  
5/15/-



**PIRATE PAN 26**

Art. 0806097N

0,62 kg

Ø 26 cm

€ tbc  
5/15/-



**PIRATE WOK**

Art. 0806096N

0,75 kg

Ø 28 cm

€ tbc  
6/12/-



**PIRATE SQUARE GRILL**

Art. 0806099N

0,94 kg

28 x 28 cm

€ tbc  
4/12/-





## PIRATE NG 7+1 Ø 20

Art. 0806083N

3,40 kg

€ tbc  
4 / 4 / 48



Ø 20 cm 4 l	Ø 20 cm 1,5 l	Ø 18 cm 1,3 l	Ø 16 cm 1,6 l	Ø 20 cm	Ø 20 / 18 / 16 cm	1x	1x

## PIRATE NG 7+1 Ø 22

Art. 0806084N

3,70 kg

€ tbc  
4 / 4 / 48



Ø 22 cm 5,3 l	Ø 22 cm 2 l	Ø 20 cm 1,7 l	Ø 18 cm 1 l	Ø 22 cm	Ø 22 / 20 / 18 cm	1x	1x

## PIRATE NG 7+1 Ø 24

Art. 0806085N

4,32 kg

€ tbc  
4 / 4 / 48



Ø 24 cm 6 l	Ø 24 cm 2,2 l	Ø 22 cm 1,8 l	Ø 20 cm 3 l	Ø 24 cm	Ø 24 / 22 / 20 cm	1x	1x

# PIRATE NG

### STONE ROCK



### VACUBLOCK System

### PATENTED



H 20 cm





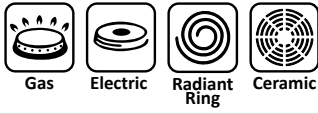
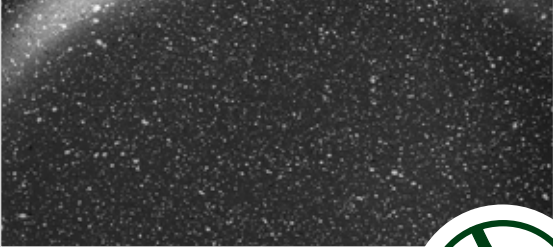

multiple layer coating

### PIRATE SPACEMASTER Ø 20 MINI

Art. 0806087N

€ tbc  
4 / 4 / 72



Ø 20 cm H 9 cm	Ø 18 cm H 8 cm	Ø 20 cm H 5 cm	Ø 20 cm	1X



### SPACEMASTER



H 15 cm



### PIRATE SPACEMASTER Ø 22

Art. 0806064N

€ tbc  
4 / 4 / -



Ø 22 cm H 10 cm	Ø 18 cm H 9 cm	Ø 22 cm H 5 cm	Ø 22 cm	1X



### PIRATE SPACEMASTER Ø 24

Art. 0806063N

€ tbc  
4 / 4 / -



Ø 24 cm H 10 cm	Ø 20 cm H 9 cm	Ø 24 cm H 5 cm	Ø 24 cm	1X



### PIRATE SPACEMASTER Ø 26

Art. 0806061N

€ tbc  
4 / 4 / -



Ø 26 cm H 5 cm	Ø 22 cm H 10 cm	Ø 18 cm H 9 cm	Ø 22 cm	2X



# FUSION MAGNETIC CERAMIC

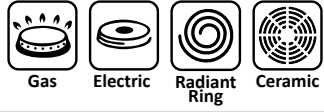

multiple  
layer  
coating



VACUBLOCK  
System



## FUSION 7+1 Ø 22

Art. 0806050N

€ tbc  
4 / 4 / -



Ø 22 cm	Ø 22 cm	Ø 20 cm	Ø 18 cm	Ø 22 cm	Ø 22 / 20 / 18 cm	1x
4,9 l	1,5 l	1,2 l	1,7 l			



## MAGNETOGRIP SYSTEM

Maniglia con sistema di connessione di nuova concezione che, attraverso l'uso di impugnature pieghevoli con elementi magnetici integrati, consente di ridurre notevolmente le dimensioni dell'imballaggio dei set di pentole e rende inoltre superfluo l'uso di una cinghia di fissaggio per stabilizzare la pentola e la padella durante il trasporto.

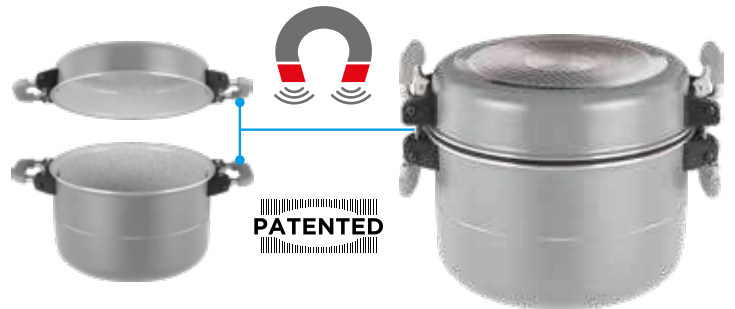
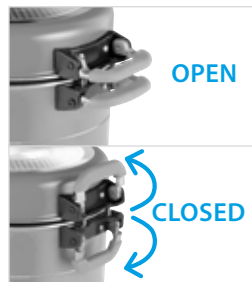



# CAREZZA

CERAMIC



PFOAfree



100%  
RECYCLED  
ALUMINIUM

## CAREZZA 7+1 Ø 22

Art. 0804082N

€ tbc  
4 / 4 / -

VACUBLOCK  
System



H 20 cm

NEW  
2023



Ø 22 cm H 14,5 cm	Ø 22 cm H 5 cm	Ø 20 cm H 5 cm	Ø 18 cm H 8 cm	Ø 22 cm	Ø 22 / 20 / 18 cm	1x



Induction



## CAREZZA SPACEMASTER Ø 22 VACUBLOCK

Art. 0804081N

€ tbc  
4 / 4 / -

NEW  
2023



Ø 22 cm H 14,5 cm	Ø 18 cm H 8 cm	Ø 22 cm H 5 cm	Ø 22 / 20 / 18 cm	1X



## CAREZZA PAN 24

Art. 0804084N

€ tbc  
5 / 15 / -

Ø 24 cm



100%  
RECYCLED  
ALUMINIUM

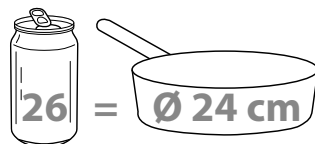

## CAREZZA SPACEMASTER Ø 20 VACUBLOCK

Art. 0804080N

€ tbc  
4 / 4 / -

NEW  
2023



Ø 20 cm H 13 cm	Ø 16 cm H 8 cm	Ø 20 cm H 5 cm	Ø 20 / 18 / 16 cm	1X



# GOURMET ROCK NG

STONE ROCK

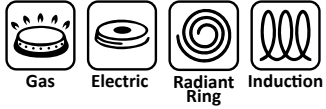

## GOURMET ROCK NG 8+1 Ø 20

Art. 0806080N

3,45 kg

€ tbc  
4 / 4 / 48



Ø 20 cm	Ø 18 cm	Ø 14 cm	Ø 18 cm	Ø 20 cm	Ø 20 cm	Ø 18 cm	1x	1x	
4 l	1,6 l	1 l	1,3 l	1,5 l					

## GOURMET ROCK GRILL

Art. 0806071N

1,15 kg

28 x 28 cm

€ tbc  
5 / 10 / 84



## GOURMET ROCK NG 9+1 Ø 22

Art. 0806081N

4,10 kg

€ tbc  
4 / 4 / 40



Ø 22 cm	Ø 22 cm	Ø 18 cm	Ø 14 cm	Ø 22 cm	Ø 18 cm	Ø 22 cm	Ø 18 cm	1x	1x
5,3 l		2,5 l	1 l	1,8 l	1,5 l				



## GOURMET ROCK NG 9+1 Ø 24

Art. 0806082N

4,20 kg

€ tbc  
4 / 4 / 48



Ø 24 cm	Ø 22 cm	Ø 20 cm	Ø 16 cm	Ø 24 cm	Ø 18 cm	Ø 24 cm	Ø 20 cm	1x	1x
6 l		3 l	1,5 l	2,2 l	1,3 l				

## GOURMET ROCK SQUARE PAN 28

Art. 0806073N

0,80 kg

28 x 28 cm

€ tbc  
4 / 12 / -

## GOURMET ROCK SQUARE PAN 26

Art. 0806072N

0,75 kg

26 x 26 cm

€ tbc  
4 / 12 / -

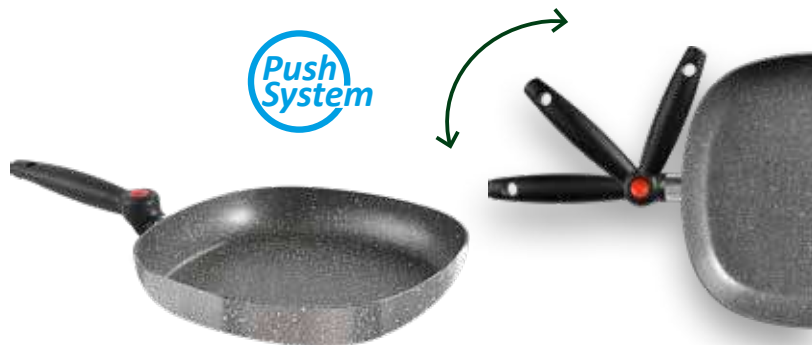



# CHOCOLATE

CERAMIC



multiple layer coating

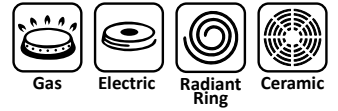

## CHOCOLATE 7+1 Ø 20

Art. 0804041N

2,75 kg

€ tbc  
4 / 4 / 60



Ø 20 cm 4 l	Ø 16 cm 1,6 l	Ø 14 cm 1 l	Ø 20 cm 1,5 l	Ø 20 cm	Ø 16 cm	1x	1x

## CHOCOLATE 9+1 Ø 22

Art. 0804042N

3,70 kg

€ tbc  
4 / 4 / 40



Ø 22 cm 5,3 l	Ø 22 cm	Ø 18 cm 2 l	Ø 14 cm 1 l	Ø 22 cm 1,8 l	Ø 20 cm 1,5 l	Ø 22 cm	Ø 18 cm	1x	1x

# COSMIC

CERAMIC



multiple layer coating

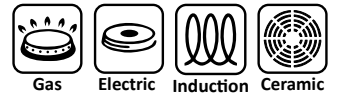

## COSMIC 8+2 Ø 22

Art. 0804013N

4,20 kg

€ tbc  
4 / 4 / 40



Melamineware

Ø 22 cm 5,3 l	Ø 18 cm 3 l	Ø 22 cm 1,5 l	Ø 22 cm	Ø 18 cm	1x	1x	1x

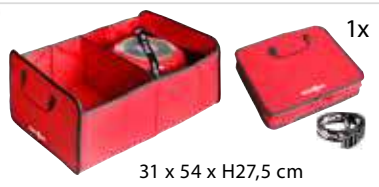

# SKIPPER

CLASSIC BLACK

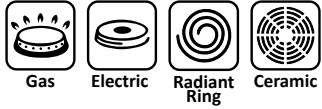

## SKIPPER 7+1 Ø 18

Art. 0806006N

2,5 kg

€ tbc  
4 / 4 / 72



Ø 18 cm	Ø 16 cm	Ø 14 cm	Ø 18 cm	Ø 18 cm	Ø 16 cm	1 x	1 x
3,3 l	1,6 l	1 l	1 l				

## SKIPPER 8+1 Ø 20

Art. 0806007N

3,08 kg

€ tbc  
4 / 4 / 40



Ø 20 cm	Ø 18 cm	Ø 14 cm	Ø 18 cm	Ø 20 cm	Ø 20 cm	Ø 18 cm	1 x	1 x
4 l	1,6 l	1 l	1,3 l	1,5 l				

## SKIPPER 4+1 Ø 22

Art. 0806008N

1,65 kg

€ tbc  
4 / 4 / 40



Ø 22 cm	Ø 22 cm	Ø 22 cm	Ø 22 cm	1 x
5 l	2 l	2 l		

## SKIPPER 9+1 Ø 22

Art. 0806009N

3,82 kg

€ tbc  
4 / 4 / 40



Ø 22 cm	Ø 22 cm	Ø 22 cm	Ø 18 cm	Ø 16 cm	Ø 20 cm	Ø 22 cm	Ø 18 cm	1 x	1 x
5 l	1,8 l	2 l	1,5 l	1,5 l					

## SKIPPER 9+1 Ø 24

Art. 0806011N

3,86 kg

€ tbc  
4 / 4 / 40



Ø 24 cm	Ø 24 cm	Ø 22 cm	Ø 20 cm	Ø 16 cm	Ø 22 cm	Ø 24 cm	Ø 20 cm	1 x	1 x
6 l	2,2 l	3 l	1,5 l	1,5 l					



# SKIPPER PAN

Pentola alluminio con fondo antiaderente. Con manico staccabile.



SOFT TOUCH



## SKIPPER PAN Ø 20

Art. 0806040N

€ tbc  
5 / 15 / -

320 g



ø 20 cm - 1 l

## SKIPPER PAN Ø 22

Art. 0806041N

€ tbc  
5 / 15 / -

380 g



ø 22 cm - 1,8 l

## SKIPPER PAN Ø 24

Art. 0806044N

€ tbc  
5 / 15 / -

420 g



ø 24 cm - 2 l

## SKIPPER PAN Ø 26

Art. 0806042N

€ tbc  
5 / 15 / -

450 g



ø 26 cm - 2,1 l

## SKIPPER 4

Art. 0806037N

€ tbc  
5 / 10 / -

750 gr



ø 20 cm - 1 l



ø 26 cm - 2,1 l



Set 4 pezzi di padelle in alluminio con fondo antiaderente e manici staccabili.

## SKIPPER 6

Art. 0806038N

€ tbc  
6 / 12 / 72

1 kg



ø 16 cm - 1,6 l

ø 20 cm - 2,6 l

ø 16 cm

ø 20 cm

Set 6 pezzi di casseruole e coperchi in acciaio con fondo antiaderente e manici staccabili.

# WOK

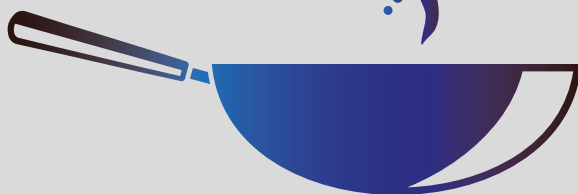

## SKIPPER WOK

Art. 0806039N

€ tbc  
6 / 12 / -

520 g

ø 28 cm



Padella Wok di alluminio con fondo antiaderente. Con manico staccabile.

# JUNIPER NG

CLASSIC BLACK

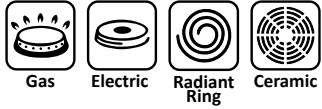

## JUNIPER NG 7+1 Ø 20

Art. 0806075N.C34

3 kg

€ tbc  
4 / 4 / 60

Ø 20 cm 4 l	Ø 16 cm 1,6 l	Ø 14 cm 1 l	Ø 20 cm 1,5 l	Ø 20 cm	Ø 16 cm	1X	1X



## JUNIPER NG 8+1 Ø 22

Art. 0806060N.C34

3,5 kg

€ tbc  
4 / 4 / 40

Ø 22 cm 5,3 l	Ø 20 cm 2,5 l	Ø 14 cm 1 l	Ø 22 cm 1,8 l	Ø 22 cm	Ø 22 cm	Ø 20 cm	1X	1X



## JUNIPER NG 8+1 Ø 24

Art. 0806067N.C34

3,94 kg

€ tbc  
4 / 4 / 48

Ø 24 cm 6 l	Ø 20 cm 3 l	Ø 16 cm 1,5 l	Ø 24 cm 2,2 l	Ø 22 cm	Ø 24 cm	Ø 20 cm	1X	1X





### JUNIPER MEPO BOX 16+9

Art. 0806077N.C34

8 kg

€ tbc  
1/2/-



Ø 22 cm 5 l	Ø 18 cm 1 l	Ø 20 cm 1,7 l	Ø 22 cm 2 l	Ø 22 cm	Ø 18 cm	1X	1X



### Melamineware

	4 x Ø 21 cm		4 x Ø 25 cm
	4 x Ø 15 cm		4 x 44 cl



### COOKING SET

Art. 0832021N

€ tbc  
6/24/-



Set posate cucina composto da 6 pezzi. Realizzato in nylon alimentare.

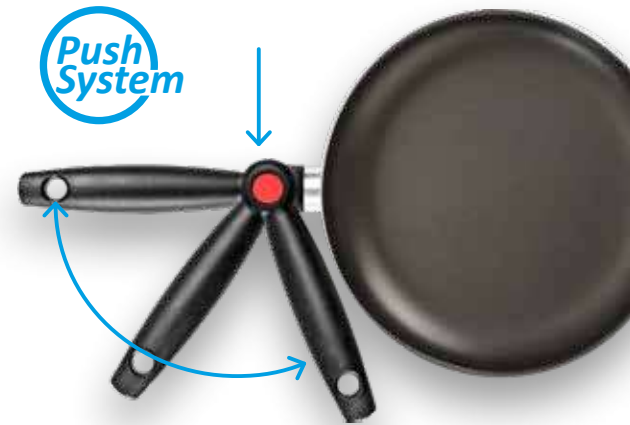

### POTGUARD

Art. 0806079N

€ tbc  
12/24/-



Ø 20 / 22 / 24 cm

Protezione per pentole e padelle realizzata in feltro di poliestere. Ideale per prevenire graffi e altri danni causati da impilaggio, stoccaggio o rimozione. Fornita in set da 3 pezzi (20-22-24 cm).

### JUNIPER PAN

Art. 0806065N.C34

700 gr

€ tbc  
4/12/-



Padella in alluminio con rivestimento antiaderente di ottima qualità. Dotata di praticissimo manico pieghevole salvaspazio brevettato.



# ACADEMY NG

INOX



## INOX Stainless Steel

Acciaio inox: Durevole e resistente agli urti. Resiste a graffi e ammaccature, rimanendo bello anche dopo anni di utilizzo. Ottimo conduttore termico: distribuisce il calore uniformemente. Igienico, facile da pulire e mantenere brillante.

### BITER

Art. 0832027C

📏 110 g



### TAKER

Art. 0832000C

📏 70 g



Praticissima pinza prendi pentola con meccanismo di sicurezza contro l'apertura accidentale. Applicazione fissa a pentole e padelle. Esecuzione stabile e robusta.

Pinza prendi pentole universale in materiale termoplastico per pentole e padelle.

### ACADEMY PAN Ø 22

Art. 0804034N

€ tbc  
4 / 4 / -



### ACADEMY DOUBLE PAN Ø 22/20

Art. 0804036N

€ tbc  
4 / 4 / -





# ACADEMY NG

INOX



PFOAfree

multiple layer coating



PFLUON



## ACADEMY NG 5+1 Ø 20

Art. 0804031N

€ tbc  
4 / 4 / 72



Ø 20 cm 3,4l	Ø 20 cm	Ø 16 cm 1,4l	Ø 20 / 18 / 16 cm	1x	1x



induction sandwich bottom



## ACADEMY NG 7+1 Ø 22

Art. 0804032N

€ tbc  
4 / 4 / 72



Ø 22 cm 4,5l	Ø 22 cm	Ø 18 cm	Ø 16 cm 1,4l	Ø 22 cm	Ø 22 / 20 / 18 cm	1x	1x

Functional Cooking Lids



VACUBLOCK System

PATENTED



## ACADEMY HIGH NG 7+1 Ø 22

Art. 0804033N

€ tbc  
4 / 4 / 40



Ø 22 cm 5,2l	Ø 22 cm	Ø 20 cm	Ø 18 cm 2,2l	Ø 22 cm	Ø 22 / 20 / 18 cm	1x	1x

## ACADEMY MINI

Art. 0804030N

€ tbc  
4 / 4 / 72



Ø 20 cm 2,8l	Ø 16 cm 1,4l	Ø 20 cm	Ø 20 cm	1x



# VOLCANO

INOX



Gas



Electric



Halogen



Freezer

**Inox**  
Stainless Steel

**FOLD-AWAY**



Ø 24 cm

## VOLCANO FOLD-AWAY Ø 24

Art. 0804026N

Ø 24 x 4,5/14,5 cm

€ tbc  
4 / 12 / -

## VOLCANO FOLD-AWAY Ø 20

Art. 0804027N

Ø 20 x 3,5/8,5 cm

€ tbc  
4 / 12 / -



Tempered Glass

heat resistant  
**SILICONE**

**Pentole collassabili per fornelli (gas ed elettrici).**

### CARATTERISTICHE:

- Pentole realizzate in silicone di alta qualità ed acciaio inox
- Coperchio in vetro con bordo antiscivolo
- Maniglie in metallo con rivestimento in silicone

## VOLCANO PAN FOLD-AWAY

Art. 0804024N

Ø 24 cm

€ tbc  
4 / 12 / -



## VOLCANO PASTA AL VOLO

Art. 0804029N

€ tbc  
4 / 4 / -



**FOLD-AWAY**



5,6 cm

3,5 cm

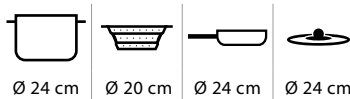

Ø 24 cm

Ø 20 cm

Ø 24 cm

Ø 24 cm

9 cm





# OMNIBOX

## INOX



### OMNIBOX 18+2 Ø 22

Art. 0804028N

4,25 kg

 € tbc  
2 / 2 / 40

**INOX**  
Stainless Steel

**Set cucina 18+2 con tutto il necessario per equipaggiare la cucina mobile.**

#### SONO COMPRESI I SEGUENTI PEZZI:

• Pentola in acciaio inox con manici silicone Ø 22 cm - 3,5 litri • Coperchio Ø 22 cm in vetro con pomolo in silicone • Casseruola in acciaio inox Ø 17 cm - 1,3 litri con manico in silicone • Coperchio Ø 17 cm in vetro con pomolo in silicone • Contenitore in plastica Ø 16 cm con coperchio • Contenitore in plastica Ø 13 cm con coperchio • Contenitore in plastica Ø 11 cm con coperchio • Padella in acciaio inox Ø 23 cm - 1,5 litri con manico in silicone • Cucchiaino • Paletta • Mestolo • Cucchiaino forato • Pelapatate • Grattugia • Forbice • Coltello • Spazzolino lava piatti • Panno per pulire/asciugare • Borsa per stivaggio • Borsa per il trasporto



### FOLD-AWAY COLANDER

Art. 0832210N

 € tbc  
6 / 24 / -

### RIDER

Art. 0830413N

 € tbc  
12 / 72 / -

Ø 22 x 3,5/11 cm

220 g

COLORS

**FOLD-AWAY**

1,5 x 1,5 x 4,8 cm

PCS. 2

COLORS



Scolapasta colassabile. Prodotto in TPR facile da pulire, resistente al calore e pieghevole.

Portamestolo in silicone.



## DAYO

Art. 0802017N



Induction



V 1,8l  
420 g  
Ø 18 x H14,5 / 21 cm



Elegante bollitore realizzato in acciaio inox.

€ tbc  
6 / 12 / -

## DAYO BLACK NG

Art. 0802018N



Induction

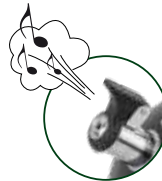

V 1,8l  
420 g  
Ø 18 x H14,5 / 21 cm



Bollitore per l'acqua di costruzione identica al modello Dayo, ma dotato di fondo all'induzione e di manici in gomma antiscivolo. Design elegante.

€ tbc  
6 / 12 / -

## STEAMER TRAVEL

Art. 0802014N



Induction



V 2,5l  
810 g  
Ø 19 x H20 cm



Bollitore con fischio in acciaio inox munito di manico isolante ripiegabile e fondo sandwich.

€ tbc  
6 / 12 / -

## KETTY

Art. 0802012N



V 1l  
150 g  
Ø 15 x H14 cm



Bollitore acqua in resistente alluminio. Dotato di manico removibile in plastica.

€ tbc  
6 / 36 / -



## AMIGO



### AMIGO 2

Art. 0830018N

€ tbc  
50 / 200 / -

1-2 Cups / 7,5 cm

### AMIGO 4

Art. 0830019N

€ tbc  
10 / 200 / -

2-4 Cups / 9 cm



Filtro per caffè in acciaio inox estremamente leggero, pieghevole e facile da montare grazie ai suoi morsetti laterali metallici flessibili.



# OUTDOOR LIFESTYLE



## MC MOKA 3

Art. 0804078N

Ø 10 x 14,5 x H15 cm



## MC MOKA 6

Art. 0804079N

Ø 12 x 17 x H20 cm

**INOX**  
Stainless Steel

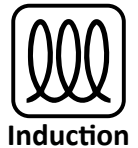

La caffettiera a induzione McMoka nasce dalla continua ricerca di nuove soluzioni, adatte ai cambiamenti e alla evoluzione dei gusti e delle abitudini dell'universo outdoor. Realizzata interamente in alluminio con fondo in acciaio, rappresenta la storica moka a cui non sappiamo rinunciare, ma con il vantaggio di una base molto ampia e di poter essere utilizzata su qualunque piano di cottura. Disponibile in 2 versioni, da 3 e da 6 persone.

## LEGEND COFFEE NG

Art. 0820033N

€ tbc  
6 / 6 / -

1 l

490 g

Ø 10 x H22 cm

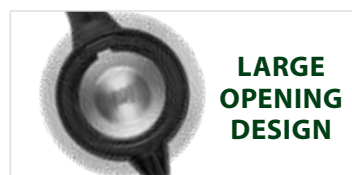

Thermos per caffè in acciaio inox a doppia parete.



## PACKPOT ULTRALITE 18

Art. 0802024N

€ tbc  
4/16/-



📦 1,2 kg



alu

Anodised



ultralight

PFOA free



**Set popote Outdoor in alluminio anodizzato per 3/4 persone.**

**MANICI PIEGHEVOLI RIVESTITI IN SILICONE TERMOISOLANTE. IL SET È COMPOSTO DA:**

- 1 pentolino con coperchio Ø 16,6 x 8,9 cm
- 1 padella Ø 16,7 x 4,4 cm
- 1 bollitore Ø 14,6 x 8,3 cm (1,1l)
- 1 mestolo in bambù
- sacchetto custodia

## PACKPOT ULTRALITE 20

Art. 0802026N

€ tbc  
4/12/-



📦 910 g



alu

Anodised



ultralight

PFOA free



**Set popote Outdoor in alluminio anodizzato per 4/5 persone.**

**MANICI PIEGHEVOLI RIVESTITI IN SILICONE TERMOISOLANTE. IL SET È COMPOSTO DA:**

**IL SET È COMPOSTO DA:**

- 1 pentolino grande con coperchio Ø 19 x 11,2 cm
- 1 pentolino piccolo con coperchio Ø 16,6 x 8,9 cm
- 1 padella Ø 19,5 x 4,5 cm
- 1 mestolo in legno
- sacchetto custodia





**COOK SET ALU 1**

Art. 0802021N

€ tbc  
5 / 15 / -

220 g

**Popote in alluminio per una persona, composta da:**

- 1 tegame Ø 18,5 cm
- 1 casseruola Ø 13,5 cm - 0,4l
- 1 coperchio Ø 13,5 cm
- 1 piatto fondo Ø 18 cm
- 1 tazza

**POTGRIP**

Art. 0802020N

€ tbc  
6 / 120 / -

80 g



Pinza prendipentole superleggera in alluminio.

**WINDSTOPPER**

Art. 0802019N

€ tbc  
6 / 12 / -

77,5 x 26 cm

210 g

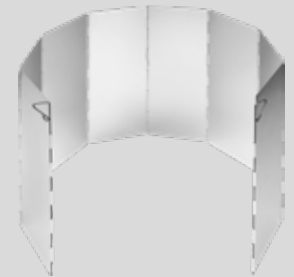

Paravento pieghevole in lamelle di alluminio per fornelli Outdoor.

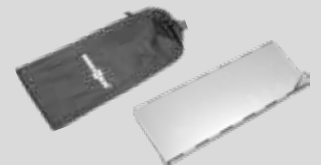
**UNILID**

Art. 0806027N

170 g



Coperchio speciale adatto per pentole con diametro da 16 a 22 cm. Utilizzabile anche come scolapasta.

**TOASTER**

Art. 0706019N

Ø 22 cm

150 g

Griglia tostapane pieghevole per fornelli a gas. Con piastra in acciaio.

€ tbc  
10 / 40 / 560**THERMATE**

Art. 0708049N

Ø 16 cm

200 g

Piastra di cottura in acciaio per fornelli a gas.

€ tbc  
6 / 12 / -



# GAS ITEMS

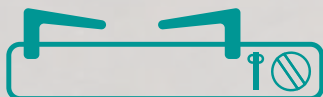

**FORNELLI  
ACCESSORI GAS**





## CUCINARE COL GAS

**Cucinare con il gas all'aperto è di norma semplice, facile e pulito. Ci sono comunque alcune importanti regole da non dimenticare:**

- E' vietato introdurre bombolette gas negli aerei
- Verificare che a destinazione siano acquistabili delle bombolette gas adatte
- Con l'aumentare del livello del mare diminuisce l'efficienza dei fornelli a gas
- Anche temperature sotto zero riducono la capacità di apparecchi a gas
- Usare sempre un paravento
- Durante la cottura usare possibilmente sempre un coperchio, per evitare che il calore si disperda

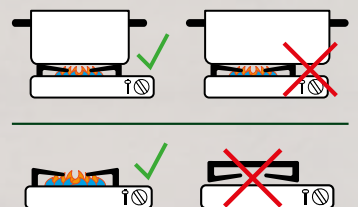



**PIEZO IGNITION**

## FLAMINA ULTRACOMPACT S

Art. 0708011N

€ tbc  
4 / 40 / -

10,5/15,5 x 10,5/15,5 x H 8 cm

8 x 8,5 x H 9,5 cm

3 kW

238 g

Mini-fornello gas pieghevole realizzato in resistente acciaio e con braccetti di supporto dentellati salvaspazio. Dotato di ottimo bruciatore, manopola di regolazione della fiamma e di accensione piezoelettrica integrata. Praticissimo da trasportare e riporre nel suo contenitore in materiale plastico.



## FLAMINA ULTRACOMPACT L

Art. 0708012N

€ tbc  
4 / 24 / -

Ø 17,5 / 18 cm x H 9,5 cm

Ø 9,5 cm x H 9,5 cm

3,5 kW

374 g

Fornello gas pieghevole ultraleggero in acciaio per camping ed Outdoor. Completo di accensione piezoelettrica e valvola di collegamento con manopola di regolazione della fiamma. Facile da riporre e trasportare nella sua pratica sacca custodia.



# OUTDOOR LIFESTYLE



**GAS**

## DEVIL HEATER SD

Art. 0708025N

€ tbc  
6 / 6 / 48

31,5 x 17 x H27,5 cm

1,5 kg

1,2 kW



Stufetta gas portatile con pannello radiante a raggi infrarossi. Accensione piezoelettrica. Funzionamento con bombole gas munite di valvola normalmente reperibili in commercio (non incluse nella fornitura). Consumo: 90 g/h



**Inox**  
Stainless Steel

# DEVIL

DOUBLE FLAME

SAFETY DEVICE  
THERMOCOUPLE



## DEVIL

Art. 0708013N

€ tbc  
3 / 3 / 72

**P** 30 mbar - without flame failure device

**L** 37,2 x 28,6 x 12,5 cm

**P** 2,2 kW

**I** 2 kg



Fornello con accensione piezoelettrica integrata e bruciatori in alluminio. Flusso del gas regolabile. Completo di pratica valigetta di trasporto. Funzionamento con cartucce gas.



## DEVIL SD NG

Art. 0708043N

€ tbc  
3 / 3 / 90

**P** 30 mbar - with flame failure device

**L** 37,2 x 28,6 x 12,5 cm

**P** 2,2 kW

**I** 2 kg



**Fornello gas portatile a cartuccia munito di manopola di regolazione della fiamma, di accensione piezoelettrica integrata e di termocoppia di sicurezza. La piastra di supporto pentole ed il coperchio del vano cartucce sono realizzati in resistente acciaio inox di facile manutenzione. Ottima erogazione della potenza mediante speciale bruciatore a doppia fiamma.**

### CARATTERISTICHE:

- Corpo realizzato in metallo verniciato con piastra di supporto pentole e coperchio per vano cartucce in acciaio inox
- Regolazione individuale della fiamma
- Con termocoppia di sicurezza
- Accensione piezoelettrica integrata
- Completa di robusta valigetta in materiale plastico per il trasporto



## DEVIL HEATSTAR

Art. 0708040N

€ tbc  
4 / 24 / -

**L** 15,5 x Ø 11,5 cm

**I** 320 g



Stufetta radiante per fornelli a gas Devil. Trasforma una normale fiamma generata dal fornello in energia termica. Costruzione in acciaio inox resistente alle alte temperature. Montaggio semplice e rapido mediante attacco a baionetta.



**INOX**  
Stainless Steel

## DEVIL MEGAGRILL

Art. 0708042N

€ tbc  
1 / 1 / -

46 x 34,5 x 10 cm

2,2 kW

4,9 kg

Il Devil Megagrill è ideale come grill da tavolo mobile per il camping o i picnic, ma può essere perfettamente utilizzato anche a casa sui balconi o sulle terrazze. Il grill viene alimentato di serie con cartucce a valvola molto compatte da 227 g disponibili in commercio. Il corpo è realizzato in robusto metallo verniciato a polvere e contiene al suo interno un potente bruciatore a doppio tubo, che viene attivato tramite un'accensione piezoelettrica e può essere regolato in modo ottimale tramite un pomello di controllo. Una piastra grill di alta qualità in alluminio pressofuso con rivestimento antiaderente ed una superficie di grigliatura di 34,5 x 28,5cm permette di fornire facilmente cibo alla griglia a 2/3 persone. Sono inclusi anche una grande padella con coperchio in vetro e una pratica borsa per il trasporto e la custodia.



## POWERGAZ 227

Art. 0708021N

€ tbc  
4 / 28 / 1176

227 g

Bombolette gas butano/propano valvolate. Conforme alla normativa UN 2037.



## POWERGAZ 450

Art. 0708036N

€ tbc  
4 / 12 / 480

450 g



## DEVIL 450

Art. 0708014N

€ tbc  
5 / 5 / 80

35,5 x 22,6 x H23 cm

30,5 x 22,6 x H12 cm

2,4 kW

1,85 kg

**Fornello a gas portatile con gambe pieghevoli. Utilizza cartucce filettate da 450 g. Include una valigetta in plastica per il trasporto.**

### CARATTERISTICHE:

- Consumo di gas: 175g/h
- Involucro (parte inferiore): plastica PBT ad alta resistenza
- Involucro (parte superiore): piastra superiore in metallo verniciato a polvere ad alta temperatura
- Griglia anticivolo in acciaio inox resistente al calore
- Raccordo di ingresso basculante per un facile montaggio della cartuccia di gas
- Manopola di sicurezza a doppio movimento con dispositivo di accensione piezoelettrica
- Controlli multifunzione integrati per un utilizzo sicuro
- Valvola/regolatore per mantenere stabile la fiamma e per prevenire il flare-up
- Gambe pieghevoli in acciaio inox



## DEVIL DOUBLE GRILL

Art. 0708017N

€ tbc  
2 / 2 / 28

✂ 67,9 x 28,6 x H12,5 cm + Plate 53 x 28 x H2,6 cm

P 2x 2,2 kW

📦 7,1 kg



GAS

**INOX**  
Stainless Steel

**GRILL PLATE INCLUDED**



Fornello gas a cartuccia a 2 fuochi con piastra grill in fusione di alluminio.



### DEVIL PLANCHA FLAT

Art. 0708027N

€ tbc  
4 / 4 / -

✂ 25,5 x 24,4 x 2,2 cm

📦 620 g

Piastra grill di alta qualità con una superficie liscia antiaderente e un fondo appositamente progettato, che garantisce una buona tenuta su tutte le stufe a gas Devil a cartuccia.



### DEVIL PLANCHA RIBBED

Art. 0708029N

€ tbc  
4 / 4 / -

✂ 25,5 x 24,4 x 2,2 cm

📦 620 g

Piastra grill di alta qualità con una superficie rigata antiaderente e un fondo appositamente progettato, che garantisce una buona tenuta su tutte le stufe a gas Devil a cartuccia.



### DEVIL SQUARE PAN

Art. 0708026N

€ tbc  
4 / 4 / -

✂ 24 x 22 x H6,7 cm

📦 700 g

Casseruola quadrata in alluminio con rivestimento antiaderente, maniglie integrate e pratico coperchio in vetro. Il fondo appositamente progettato garantisce una tenuta sicura su tutti i fornelli a cartuccia a gas della linea Devil. Costruzione di alta qualità con bordi sagomati che impediscono la deformazione causata dal calore.



### DEVIL GRILL PLATE

Art. 0708019N

€ tbc  
12 / 12 / -

✂ Ø 31 cm

📦 400 g

Griglia per fornello Devil.





# STOVE

## COLLECTION



### MAGMA

Art. 0708050N

€ tbc  
5 / 5 / 90

- P** 30 mbar
- 43 x 27 x H8 cm
- P** 2x 1,6 kW
- 1,42 kg

Fornello gas a 2 fuochi stabile e compatto. La struttura è in metallo verniciato a polvere con griglia di appoggio in nickel cromato resistente a deformazioni.

### PHOENIX 30

Art. 0708052N

€ tbc  
1 / 5 / 80

- P** 30 mbar - without flame failure device
- 45,9 x 29,6 x H8,2 cm
- P** 2x 1,2 kW
- 1,6 kg

Fornello a gas a 2 fuochi con bruciatori regolabili. Resistente struttura in metallo verniciato a polvere. Funzionamento con bombole a gas.

### PHOENIX 50

Art. 0708056N

€ tbc  
1 / 5 / 50

- P** 50 mbar - without flame failure device
- 45,9 x 29,6 x H8,2 cm
- P** 2x 1,2 kW
- 1,6 kg



**PULSE  
IGNITION**

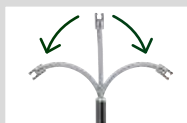

**FLEXIBLE NECK  
360° ROTATE**

### FIRESTICK

Art. 0712135N

€ tbc  
10 / 200 / -

- 23,5 x 1,5 x 1,5 cm
- 75 g



Accendino ricaricabile USB con braccio flessibile ed interruttore integrato. La soluzione pratica, sicura e sostenibile per accendere fornelli e grill a gas. Corpo in metallo. Completo di cavetto di ricarica micro-USB.



# ARISTO



Fornello gas a 2 o 3 fuochi con base e coperchio in metallo verniciato a polvere.  
Doppio raccordo di collegamento: filettato 1/4" sx o portagomma.



## ARISTO 2/30

Art. 0708053N

€ tbc  
1 / 4 / 36

**P** 30 mbar - without flame failure device

51 x 31 x 12 cm

**P** 2x 1,6 kW

4,6 kg

## ARISTO 2/50

Art. 0708054N

€ tbc  
1 / 4 / 36

**P** 50 mbar - with flame failure device

51 x 31 x 12 cm

**P** 2x 1,6 kW

4,6 kg

## ARISTO 3/30

Art. 0708057N

€ tbc  
1 / 4 / 48

**P** 30 mbar - without flame failure device

51 x 31 x 12 cm

**P** 2x 1,6 kW + 1x 1 kW

5 kg

## ARISTO 3/50

Art. 0708058N

€ tbc  
1 / 4 / 32

**P** 50 mbar - with flame failure device

51 x 31 x 12 cm

**P** 2x 1,6 kW + 1x 1 kW

5 kg



SAFETY DEVICE  
THERMOCOUPLE



SAFETY DEVICE  
THERMOCOUPLE



SAFETY DEVICE  
THERMOCOUPLE

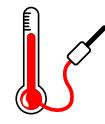

SAFETY DEVICE  
THERMOCOUPLE



## ARISTO BAG

Art. 0708039N

€ tbc  
1 / 1 / -

62 x 33 x 11 cm

Pratica sacca custodia e da trasporto per il fornello a gas Aristo.  
Adatto per i modelli a 2 e 3 fuochi. Materiale 100% poliestere.



# GAS REG

## GAS REG D



Regolatori a gas per bassa pressione, adatti per bombole gas germaniche con un peso lordo fino a 14 kg. Solo per utilizzo per campeggio (grill a gas, fornelli, lampade, ecc).

## GAS REG



Regolatore gas per bombole da campeggio. Con dispositivo di sicurezza anti-rottura del tubo. Testato DIN-DVGW.

## GAS REG ITA



Regolatore gas per bombole di fabbricazione italiana. Testato IMQ.

# GAS KIT

Kit di collegamento composto da un regolatore a bassa pressione con taratura fissa (30 mbar), 1,5m di tubo GPL e 2 fascette stringitubo.

0712168N -> Adatto per bombole attacco Italia.  
0712170N -> Adatto per bombole attacco CG.



## GAS KIT

Art. 0712168N

€ tbc  
5 / 10 / -



## GAS KIT CG

Art. 0712170N

€ tbc  
5 / 10 / -

*p*



PACK

M.O.

Master



		<i>p</i>		PACK	€ tbc	M.O.	Master	
GAS REG D	Art. 0712059C	50 mbar	1/4" L	1X	€ tbc	5	10	-
GAS REG D	Art. 0712059N	50 mbar	1/4		€ tbc	10	50	-
GAS REG D	Art. 0712063C	30 mbar	1/4" L	1X	€ tbc	5	10	-
GAS REG D	Art. 0712063N	30 mbar	1/4		€ tbc	10	50	-
GAS REG 50	Art. 0712157C	50 mbar	1/4" L	1X	€ tbc	5	10	-
GAS REG 50	Art. 0712157N	50 mbar	1/4		€ tbc	10	50	-
GAS REG	Art. 0712158C	30 mbar	Ø 8 mm	1X	€ tbc	5	10	-
GAS REG	Art. 0712158N	30 mbar	Ø 8 mm		€ tbc	10	50	-
GAS REG ITA	Art. 0712243C	30 mbar	1/4" L - Ø 8 mm	1X	€ tbc	5	10	-
GAS REG ITA	Art. 0712243N	30 mbar	1/4" L - Ø 8 mm		€ tbc	10	50	-

# GAS REG CARTRIDGE



Art. 0712078N

€ tbc  
5 / 10 / -

*p* 30 mbar



Art. 0712079N

€ tbc  
5 / 10 / -

*p* 50 mbar

Gruppo regolatore che consente di alimentare apparecchi gas a bassa pressione mediante cartucce gas filettate EN417 evitando di dover trasportare pesanti bombole gas. Disponibile in 2 versioni.

Versione 30mbar: attacco portagomma, senza tubo gas

Versione 50mbar: attacco 1/4" sx, con tubo gas





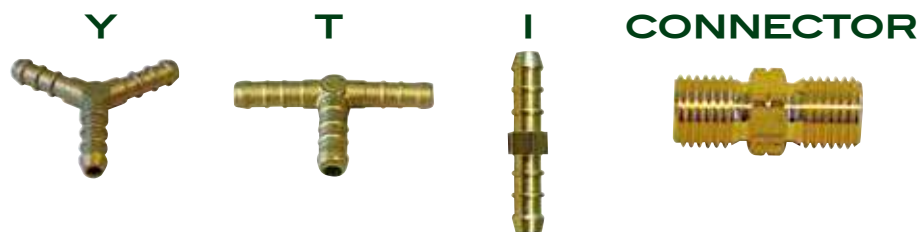

## CONNECTOR



Raccordo portagomma.

			PACK	M.O.	Master		
CONNECTOR Y	Art. 0712014C	3x Ø 8 mm	1X	€ tbc	5	10	-
CONNECTOR Y	Art. 0712014N	3x Ø 8 mm		€ tbc	10	200	-
CONNECTOR T	Art. 0712029C	3x Ø 8 mm	1X	€ tbc	5	10	-
CONNECTOR T	Art. 0712029N	3x Ø 8 mm		€ tbc	10	200	-
CONNECTOR I	Art. 0712224C	2x Ø 8 mm	1X	€ tbc	5	10	-
CONNECTOR I	Art. 0712224N	2x Ø 8 mm		€ tbc	10	200	-
CONNECTOR	Art. 0712270C	2x 1/4" L	1X	€ tbc	5	10	-
CONNECTOR	Art. 0712270N	2x 1/4" L		€ tbc	10	200	-

## CALIBER

Art. 0712076N

€ tbc  
10 / 200 / -

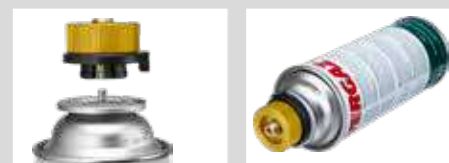

Praticissimo adattatore per utilizzare le diffusissime cartucce gas 227g come bombolette gas filettate.



## ADAPTOR ITA



Adattatore da connessione.



			PACK	M.O.	Master	
ADAPTOR ITA	Art. 0712251C	1/4" L - Ø 8 mm	1X	5	10	-
ADAPTOR ITA-CG	Art. 0712011C		1X	5	10	-
ADAPTOR ITA-DE	Art. 0712080C		1X	5	10	-



## G-HOSE



Tubi gas per collegamento a regolatore bassa pressione. Da utilizzare con grill a gas, fornelli, frigoriferi, lanterne, ecc. Resistente fino a -20°C.

				PACK	M.O.	Master		
G-HOSE 100	Art. 0712124C	100 cm	1/4" L - 1/4" L	1X	€ tbc	5	10	-
G-HOSE 100	Art. 0712124N	100 cm	1/4" L - 1/4" L		€ tbc	5	25	-
G-HOSE 200	Art. 0712074C	200 cm	1/4" L - 1/4" L	1X	€ tbc	5	10	-
G-HOSE 200	Art. 0712074N	200 cm	1/4" L - 1/4" L		€ tbc	5	25	-
G-HOSE 300	Art. 0712075C	300 cm	1/4" L - 1/4" L	1X	€ tbc	5	10	-
G-HOSE 300	Art. 0712075N	300 cm	1/4" L - 1/4" L		€ tbc	5	25	-



## G-HOSE ITA

Art. 0712248N

€ tbc  
1 / 1 / 30 Ø int. 8 mm x 50 m

Tubo gas in PVC rinforzato. Conforme alla normativa UNI-CIG. Omologato.



# HOUSEHOLD



**CONTENITORI E BACINELLE  
PORTARIFIUTI  
STENDIBIANCHERIA**



## INFO



## MY CAMPER MY HOME



Nelle pagine seguenti vi presentiamo pratiche innovazioni per la gestione domestica del vostro veicolo ricreazionale. L'obiettivo è di fare in modo che in camper ci si senta a proprio agio come se si fosse a casa propria e questo, ovviamente, senza dover rinunciare alle comodità di tutti i giorni. Perché una cosa è chiara a tutti i campeggiatori: la casa viaggia sempre con noi e deve essere curata di conseguenza.

## NE RISULTA UNA MOLTIPLICITÀ DI DOMANDE:

- Qual è il modo migliore per lavare le mie stoviglie?
- Come evitare odori fastidiosi all'interno del veicolo?
- Quali soluzioni sono disponibili per conservare piatti e bicchieri in modo sicuro?

E molto altro ancora a cui cerchiamo di dare una risposta con suggerimenti focalizzati su prodotti e soluzioni innovative - con il chiaro obiettivo di dare un contributo attivo per rendere la vacanza in camper il più piacevole possibile.



## VINIS

Art. 0203051N

€ tbc  
10 / 420 / 420

V 14l

400 g



Secchio multiuso in plastica alimentare.



## CLEO NG

Art. 0203063N

€ tbc  
24 / 24 / 288

V 13l

35 x 36 x 18 cm

430 g



Bacinella multiuso con manici pieghevoli.



for Vinis only

## OPTIONAL

## VINSERT

Art. 0203052N

€ tbc  
10 / 660 / 660

Ø 33 cm

220 g



Inserto per secchio multiuso Vinis. In plastica ad uso alimentare.

## VINCAP

Art. 0203058N

€ tbc  
12 / 48 / -

Ø 36,3 x H2,3 cm

190 g



Coperchio in materiale plastico per secchio multiuso Vinis.

## ASSORTED



## MERLIN

Art. 0203071N

€ tbc  
6 / 36 / -

V 14l



Cesto multiuso in materiale plastico flessibile e ad uso alimentare.



12 L

## POOL

Art. 0812011N

€ tbc  
6 / 24 / -

V 12l

29 x 29 x 16 cm

280 g

Polyester / PVC

Lavello pieghevole con bordo rinforzato.



waterproof



16 L

## POOL ROUND

Art. 0812010N

€ tbc  
4 / 20 / -

V 16l

Ø 33 x 25 cm

400 g

100% PVC

Secchio rotondo pieghevole con bordi rinforzati e pratico organizer ad aggancio.



## BUCK

Art. 0812012N

€ tbc  
6 / 6 / -

V 8l

Ø 25 x 23 cm

450 g

Secchio pieghevole in nylon.





# INFO

I casalinghi pieghevoli sono un'alternativa salvaspazio alle tradizionali ciotole, secchi e bacinelle e non dovrebbero mancare in nessuna delle moderne attrezzature per camper. Sono molto facili da ripiegare, versatili e, soprattutto quando lo spazio è limitato, ideali per lo stivaggio. Per poterlo utilizzare, è sufficiente esercitare una piccola pressione sul fondo. Tutti i prodotti Brunner-FoldAway possono essere ripiegati con la stessa facilità dopo l'uso.

## CARATTERISTICHE GENERALI DEL PRODOTTO:

- Materiale: Plastica PP/TPU a stabilità dimensionale
- Leggero
- Stivaggio salvaspazio
- Facile da pulire
- Durevole
- Sicuro da usare



## VINIS FOLD-AWAY

Art. 0203062C.C9N

€ tbc  
1 / 1 / -

- V 14 l
- Ø 38 x H23 (+24) cm
- Ø 40 x H10 cm
- 670 g

**Paniere collassabile realizzato in materiale plastico TPE resistente al calore, alle rotture e facile da pulire. In caso di inutilizzo si ripiega in modo compatto.**

### CARATTERISTICHE:

- Adatto per uso alimentare
- Resistente al calore fino a 125°C
- Resistente al gelo
- Con maniglia da trasporto

COLOR



## CLEO FOLD-AWAY

Art. 0203064C.C9N

€ tbc  
12 / 12 / 216

- V 13 l
- 35,3 x 36,3 x H17 cm
- 35,3 x 36,3 x H6,5 cm
- 640 g

Bacinella collassabile Cleo FoldAway. Realizzata in materiale TPE/PP di alta qualità con comode maniglie pieghevoli.

COLOR



# FOLD-AWAY

for Vinis Fold-Away only



## OPTIONAL

## VINCAP FOLD-AWAY

Art. 0203065N

€ tbc  
12 / 24 / -

- Ø 38 x 2,5 cm

Coperchio in materiale plastico (100% PP) per paniere Vinis Fold-Away.



## IRIS FOLD-AWAY

Art. 0203067N.C59

€ tbc  
12 / 12 / 120

- V 9 l
- Ø 37,5 x H14 cm
- Ø 37,5 x H5 cm
- 430 g

Lavello pieghevole costruito in resistente materiale plastico. Molto compatto da riporre e facile da trasportare grazie allo speciale sistema Fold-Away.





### DRUM 10 FOLD-AWAY

Art. 0203069N

€ tbc

4 / 16 / 192

✓ 10 l

🔒 Ø 32 x H25 cm

🔒 Ø 32 x H7 cm

📏 610 g

COLOR



Bacinella pieghevole in plastica robusta. Il pratico sistema FoldAway permette di ripiegare in modo compatto e di risparmiare spazio.

### DRUM 15 FOLD-AWAY

Art. 0203074N

€ tbc

6 / 12 / 180

✓ 15 l

🔒 Ø 36 x H28 cm

🔒 Ø 36 x H8,2 cm

📏 710 g

COLOR



Bacinella pieghevole in plastica robusta. Il pratico sistema FoldAway permette di ripiegare in modo compatto e di risparmiare spazio.



### HOLDALL FOLD-AWAY

Art. 0203070N

€ tbc

6 / 12 / 96

✓ 16 l

🔒 46,1 x 34,2 x 18,4 cm

🔒 46,1 x 34,2 x 4,9 cm

📏 550 g

COLOR



Bacinella pieghevole in plastica robusta. Il pratico sistema Fold-Away permette di ripiegare in modo compatto e di risparmiare spazio.

### LOTUS FOLD-AWAY

Art. 0203068N

€ tbc

8 / 8 / 128

✓ 36 l

🔒 54 x 39 x 24 cm

🔒 54 x 39 x 7,1 cm

📏 770 g

COLOR



Lavello pieghevole costruito in resistente materiale plastico. Molto compatto da riporre e facile da trasportare grazie allo speciale sistema Fold-Away.



## TANQ FOLD-AWAY

Art. 0203066N.C50

€ tbc  
8 / 8 / 256

- 13 l
- 30,5 x 30 x 20 cm
- 30,5 x 30 x 6 cm
- 500 g



Lavello pieghevole realizzato in robusto materiale plastico con maniglie per il trasporto integrate e scolo chiudibile mediante tappo. Molto compatto da riporre e facile da trasportare grazie allo speciale sistema Fold-Away.

## BOWLIN



TPE / ABS

**FOLD-AWAY**



M.O.

Master



		Ø 20 x 8 cm	Ø 20 x 2,3 cm	155 g	€ tbc	20	100	-
<b>BOWLIN 20</b>	Art. 0203076N.C20	Ø 20 x 8 cm	Ø 20 x 2,3 cm	155 g	€ tbc	20	100	-
<b>BOWLIN 22</b>	Art. 0203077N.C20	Ø 22 x 8,5 cm	Ø 22 x 2,5 cm	198 g	€ tbc	20	100	-
<b>BOWLIN 25</b>	Art. 0203078N.C20	Ø 25 x 10 cm	Ø 25 x 3 cm	283 g	€ tbc	20	100	-

Ciotole pieghevoli salvaspazio in TPE resistente al calore con bordo in plastica perimetrale. Compatte e leggere. Molteplici usi. Adatte per alimenti e lavabili in lavastoviglie. Disponibili in 3 misure.

NEW  
2023



## PURA

Art. 0420030N

€ tbc  
10 / 40 / -

Base Ø 10 x H3 cm - Brush Ø 8 x H12 cm

132 g

PP / TPE

**Spazzola per lavaggio stoviglie con serbatoio del detersivo integrato. Ideale per una pulizia efficace e delicata di stoviglie e pentole. Munita di speciale pulsante che aziona una piccola pompa inserita nel corpo della spazzola, permettendo un dosaggio mirato del detersivo da utilizzare.**

### CARATTERISTICHE:

- Corpo spazzola in robusto materiale plastico
- Serbatoio detersivo integrato con pulsante di dosaggio
- Con pratico piattino d'appoggio



## FOLD-AWAY GLASS

Art. 0830410N

€ tbc  
10 / 200 / -

Ø 8 x 1,5/8 cm

200 ml

COLORS

C30 C34

**FOLD-AWAY**

Bicchieri pieghevole in silicone.



## FOLD-AWAY FUNNEL

Art. 0830414N

€ tbc  
12 / 36 / -

Ø 12 x 4/13,5 cm

COLORS

C30 C34

**FOLD-AWAY**

Imbuto pieghevole in silicone.





## DROPPER FOLD-AWAY

Art. 0420040N

€ tbc  
6 / 12 / -
 36,5 x 31 x H12 cm

 36,5 x 31 x H6 cm



Scolapiatti collassabile con portaposate. Realizzato in materiale plastico.



## DRIPDISH 90

Art. 0420037N

€ tbc  
6 / 12 / -
 49,5 x 34 x 8,8 cm

 850 g

Scolapiatti triangolare a 2 elementi realizzato in resistente materiale plastico. Ideale per l'utilizzo in spazi ristretti.



## DIARID

Art. 0420029N

€ tbc  
6 / 6 / 48
 37 x 33 x 17,2 cm

100% ABS



Bacinella scolapiatti con involucro in materiale plastico e griglia in metallo. Completa di portaposate amovibile e scarico incorporato.



## PANDORA

Art. 0404021N

€ tbc  
10 / 40 / -

**Resistente portabevande in plastica per bottiglie.**

### CARATTERISTICHE:

- Con staffa di fissaggio flessibile
- Ideale per auto e camper
- Adatto per bottiglie fino a 2 litri



## TRIO

Art. 0420004N

€ tbc  
12 / 24 / -
 Ø 28 x H77 cm

 Ø 28 x H4 cm

 300 g

Portaoggetti pensile. Composto da tre cestini inseribili in metallo.



## FOOD COVER

Art. 0420009N

€ tbc  
20 / 100 / -
 34 x 34 x 22 cm

 40 g

Zanzariera coprivivande in fitta rete. Telaio pieghevole.



## GLASS BASE

Art. 0830001N

€ tbc  
12 / 48 / -

PACK 6X

Portabicchieri in plastica. Adatto per bicchieri in plastica da 200 ml. Colori assortiti.



# RESPECT YOUR HOSTS



## BIO BOY COMPACT

Art. 7427015N € tbc  
12 / 12 / -

- 32,5 x 28,5 x H66 cm
- 32,5 x 28,5 x H7 cm
- 650 g

Telaio portarifiuti smontabile realizzato in materiale plastico. Adatto per sacchetti rifiuti fino a 50 litri.

## BIO BOY NG

Art. 7427017N € tbc  
12 / 12 / -

- 32,5 x 28,5 x H66 cm
- 32,5 x 28,5 x H7 cm
- 650 g

Telaio portasacchetto rifiuti con scomparto portasacchetti. Struttura in materiale plastico. Completo di 10 sacchetti portarifiuti.

Set 3pcs



FIXING SET

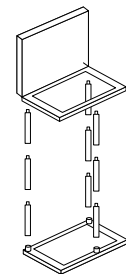

## BIO BOY DIFCOL

Art. 7427013N € tbc  
4 / 4 / 48

- 99 x 28,5 x H66 cm
- 32,5 x 28,5 x H22 cm
- 2,1 kg

Telai portasacchetto rifiuti modulari per la raccolta differenziata. Realizzati in materiale plastico con coperchi differenziati per colore. Montaggio e smontaggio semplici e rapidi. Facili da riporre e trasportare. Adatti per sacchi fino a 50l di volume. In set da 3 pezzi.







**PLITTER**

Art. 7427026N € tbc  
6 / 6 / -

- 📏 32 x 27,5 x H38,5 cm
- 📏 31 x 38 x H6,5 cm
- 📖 1,65 kg

Cestino per rifiuti con struttura pieghevole in materiale plastico.



**BOGO**

Art. 7427019N € tbc  
10 / 40 / -

- 📏 27,5 x 35,5 x H36,5 cm
- 📏 27,5 x 4,5 x 48 cm
- 📖 300 g

Telaio portarifiuti pieghevole in materiale plastico.



**SNAPSTER**

Art. 7427028N € tbc  
10 / 70 / -

- 📏 37,5 x 12,5 cm
- 📖 100 g

Portasacchetti rifiuti con telaio in materiale plastico a chiusura automatica. Montaggio semplice e rapido a porte, ante e pareti.



**TRAPSY**

Art. 7427035N € tbc  
12 / 108 / -

- 📏 13,9 x 10,8 x 4,5 cm
- 📖 85 g

Pratico portasacchetti per rifiuti utilizzabile in molteplici situazioni: veicoli ricreazionali, camping, nautica, cucina, bagno. Realizzato con telaio in materiale plastico a chiusura automatica bloccadodori. Utilizzo anche con una mano sola. Montaggio semplice e rapido. La fornitura comprende 20 sacchetti portarifiuti (capacità 3,5l ca).



**TRAPSY BAGS**

Art. 7427079N € tbc  
12 / 120 / -

- PACK 20X
- 3,5l

Sacchetti di ricambio per portarifiuti Trapsy.



NEW  
2023



## PILLAR FOLD-AWAY

Art. 7427022N

€ tbc  
6/12/-

- 25,5 x 18,5 x H29 cm
- 25,5 x 9,5 x H29 cm
- 620 g
- PP - TPR
- 8 l

Cestino portarifiuti con coperchio ad apertura manuale, caratterizzato da una struttura pieghevole Fold-Away che in caso di inutilizzo consente di ridurre il suo volume d'ingombro di più del 50%. Corpo in resistente materiale termoplastico con fascia in TPR. Utilizzo come portarifiuti indipendente da pavimento oppure appeso a pareti, porte o ante.



# FOLD-AWAY

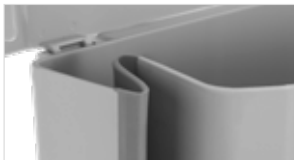

NOT INCLUDED

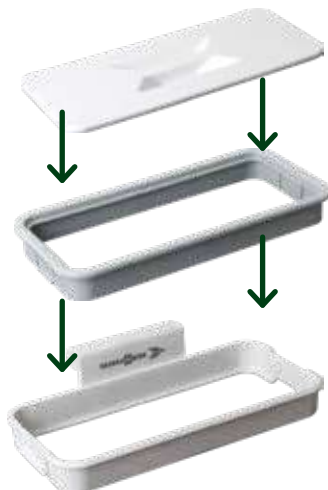

## ONE WAY

Art. 7427020N

€ tbc  
10/80/-

- 23,7 x 11 x 2,9 cm
- 138 g
- PP

**One Way è un pratico portarifiuti utilizzabile a mani libere, che si aggancia a qualsiasi cassetto o mobiletto. Il telaio a clip intelligente garantisce un fissaggio sicuro dei sacchetti di plastica. One Way è perfetto per mantenere la cucina e il bagno puliti e in ordine.**

### CARATTERISTICHE:

- Utilizzo a mani libere
- Intelligente clip telaio
- Custodia robusta in plastica
- Montaggio facile e senza viteria
- Lavabile in lavastoviglie
- Con coperchio
- Per sacchetti della spazzatura da 30 l

EASY  
INSTALLATION



NO SCREWS OR  
INSTALLATION





**PILLAR**

Art. 7427021N

€ tbc  
8 / 8 / -

22/26,5 x 9/12 x H30 cm

380 g

100% PP

5,5 l

COLOR

C06 C00



**Cestino pensile con coperchio ad apertura manuale dal design curato, innovativo e funzionale.**

**MONTAGGIO SEMPLICE MEDIANTE:**

- Supporto di montaggio da avvitare a pareti o ante armadi
- Avvitamento

**PILLAR XL**

Art. 7427025N

€ tbc  
6 / 6 / 60

31,5 x 18 x H31,5 cm

476 g

100% PP

10 l

COLOR

C06 C00



**Cestino portarifiuti pensile con coperchio.**

**MONTAGGIO SEMPLICE MEDIANTE:**

- Supporto di montaggio da avvitare a pareti o ante armadi
- Mediante piastra di fissaggio regolabile in altezza da avvitare ad ante e porte
- Con speciale supporto da agganciare alla struttura tubolare dei mobiletti cucina

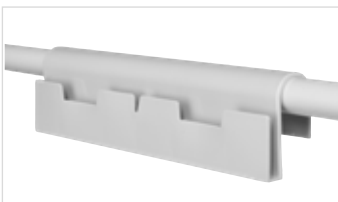

25 pcs



25 pcs

**OPTIONAL****PILLARBAG**

Art. 7427008N

€ tbc  
10 / 100 / -

PACK 25X

5,5 l

Sacchetti in plastica biodegradabile per contenitori portarifiuti Pillar.

**BIO- DEGRADABLE****PILLARBAG XL**

Art. 7427009N

€ tbc  
10 / 50 / -

PACK 25X

10 l

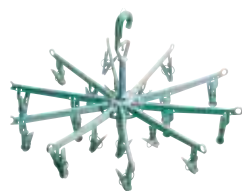

## EXPRESS

Art. 7202810N

€ tbc  
15 / 30 / -

✂ Ø 45 cm

Stendibiancheria rotondo in materiale plastico. Con 10 aste ripiegabili e 20 mollette.



## JOKER

Art. 7202805N

€ tbc  
6 / 12 / -

✂ Ø 45 cm

Stendibiancheria ovale con 24 mollette in materiale plastico di alta qualità. Gancio di fissaggio con chiusura a molla.



## SUN TIME

Art. 7202808N

€ tbc  
10 / 20 / -

✂ 70 x 34 cm

Stendibiancheria rettangolare in materiale plastico. Con 34 mollette. Pieghevole.



## POPS

Art. 7202824N



€ tbc  
12 / 48 / -

✂ max. 90 cm

📦 102 g

Stendibiancheria con ventose.



## DRYLINE

Art. 7202799N

€ tbc  
12 / 72 / -

✂ 1,5 m

Corda stendibiancheria elastica utilizzabile senza mollette. I singoli indumenti vengono incastrati tra i filamenti elastici attorcigliati su loro stessi. Fissaggio mediante ventose.



## RAPID METAL

Art. 7427050C

PACK 1X

€ tbc  
12 / 48 / -

Art. 7427050N

PACK -

€ tbc  
12 / 48 / -

✂ 40 cm

Asta con sette ganci spostabili in plastica realizzata in metallo cromato.



## ARIAL

Art. 7427054N

€ tbc  
5 / 20 / -

✂ 60 x 9,5 cm

Appendino a 8 ganci per caravan.



## BONE DRY

Art. 7202798N

€ tbc  
20 / 100 / -

📦 160 g

Corda stendibiancheria estensibile con 2 ganci di fissaggio alle estremità e 12 mollette in metallo. Lunghezza: 1,9 / 3,5 m.

## DRYWHEEL

Art. 7202802N

€ tbc  
6 / 48 / -

✂ 5,5 m

Corda stendibiancheria in PP con pratico avvolgitore.



# LAUN-TREE 3A



3A

Ø 40 mm

## LAUN-TREE 3A

Art. 7202811N

€ tbc  
6/6/54

121 (x3) x H150 cm

80 x 25 x 12 cm

2,3 kg

Stendibiancheria con struttura pieghevole in alluminio anodizzato. Lunghezza complessiva corda: 14 metri.



3A

Ø 40 mm

## LAUN-TREE 3A WITH EXTENSION

Art. 7202801N

€ tbc  
6/6/-

121 (x3) x H150 cm

80 x 25 x 12 cm

2,8 kg

Stendibiancheria Laun-Tree con supplemento in alluminio per dare più spazio alla biancheria. La lunghezza della corda aumenta a seconda del modello scelto di 7,2/7,5 m.



## MARY

Art. 7202829N

€ tbc  
12/24/-

51 x 26 x 13 cm

500 g



## MARY XL

Art. 7202827N

€ tbc  
5/10/-

80,5 x 54,5 x 22 cm

670 g



Stendibiancheria pratico e compatto per le finestre di camper e caravan.



## FRANKY

Art. 0203038N

€ tbc  
8 / 8 / -

125 x 26,5 cm

69 x 19 cm

450 g

Scopa per camping con speciale meccanismo di apertura che raddoppia la larghezza utile della spazzola. Dotata di pratica paletta raccogli polvere.



## SPIK

Art. 0203035N

€ tbc  
12 / 24 / -

70/118 x 25 cm

340 g

Scopa per tende e verande con pratico manico telescopico.



## BENJAMIN

Art. 0203025N

€ tbc  
12 / 24 / -

118 x 25 cm

150 g

Pratica scopa per tende e verande.



## TOUCAN

Art. 0203033N

€ tbc  
24 / 24 / -

86/124 x 30 cm

700 g

Scopa per camping con manico telescopico in alluminio.



## TIDY

Art. 0203020N

€ tbc  
24 / 24 / -

18 x 21 x 4,5 cm

160 g



RUBBER

Miniset paletta/scopetta di minimo ingombro. Realizzato in materiale plastico.



## BUNNY

Art. 0203032N

€ tbc  
10 / 60 / -

27 x 21 x 4,5 cm

170 g



RUBBER

Set paletta/scopetta di minimo ingombro. Realizzato in materiale plastico.



## BUTLER

Art. 0203030N

€ tbc  
10 / 50 / -

31 x 22 x 10,5 cm

150 g



Set paletta/scopetta in materiale plastico.



## SCOOPY

Art. 0203034N

€ tbc  
10 / 40 / -

34 x 23,5 x 10 cm

175 g



Set paletta/scopetta di ampie dimensioni.



**BARRICK SINGLE**

Asta di bloccaggio con molla interna e terminali antiscivolo.

**BARRICK DOUBLE**

Doppia asta di bloccaggio per mobiletti e frigoriferi. Telescopico e bloccabile mediante rotazione.



		PACK	Mi.O.	Master					
BARRICK SINGLE S	Art. 0201100N	26/43 cm	20 g	2X	€ tbc	20	100	-	
BARRICK SINGLE M	Art. 0201101N	41/71 cm	50 g	2X	€ tbc	20	100	-	
BARRICK DOUBLE S	Art. 0201098N	26/43 x H8,5 cm			€ tbc	20	100	-	
BARRICK DOUBLE M	Art. 0201099N	41/71 x H8,5 cm			€ tbc	20	100	-	

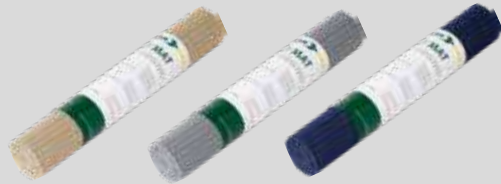
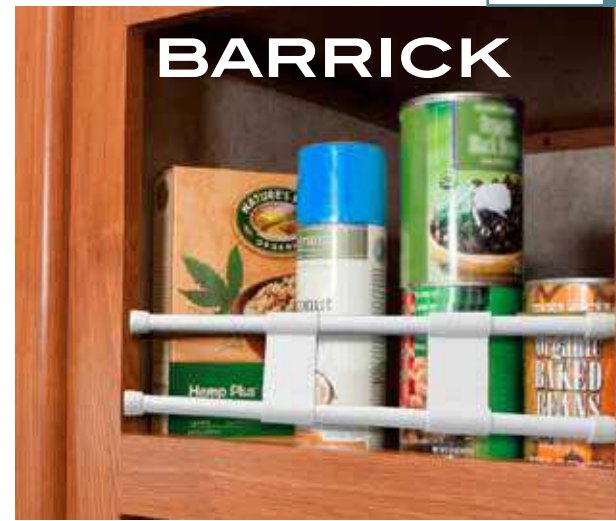

PHTHALATE free

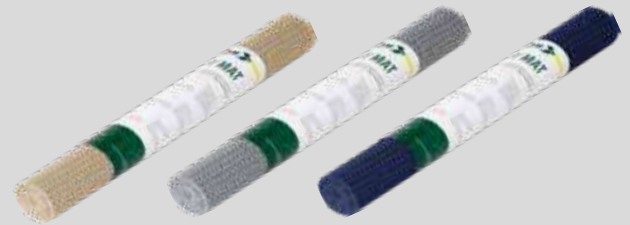
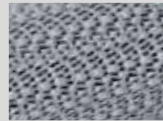
**STAY MAT S**

Art. 0201030N

€ tbc  
24 / 24 / -

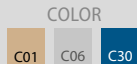

- 30 x 150 cm
- 100% PVC

Stuoia antiscivolo resistente e lavabile fino a 30°C. Tagliabile a piacere.

**STAY MAT M**

Art. 0201031N

€ tbc  
24 / 24 / -

- 50 x 150 cm
- 100% PVC

Stuoia antiscivolo resistente e lavabile fino a 30°C. Tagliabile a piacere.

**SALVAR**

Art. 0420046N

€ tbc  
10 / 20 / -

- 34 x 25,5 x H6 cm
- 110 g

Portabicchieri/portatazze universale in materiale espanso. 12 posizioni per bicchieri e tazze di diverse misure.



**SOFT FOAMED PLASTIC**

**SALVAR SLOT**

Art. 0420048N

€ tbc  
10 / 10 / -

- 33,5 x 25 x H10 cm
- 128 g

Portapiatti in schiuma EVA di alta qualità per trasportare fino a 10 piatti in modo sicuro e silenzioso in veicoli ricreativi ed imbarcazioni. Adatto per piatti piani, piatti fondi e piatti da dessert.



**SOFT FOAMED PLASTIC**

**HOBEX**

Art. 7540204N

€ tbc  
6 / 12 / 72

- 37 x 28 x 12 cm

Mobiletto pensile in materiale plastico. Con fori di aggancio.

**MULTI SHELF**

Art. 7540213N

€ tbc  
6 / 12 / -

- 27 x 11 x 12 cm

Mensola portaccessori in materiale plastico.



# COOLING



**PRODOTTI ELETTRICI AC E DC  
BORSE TERMICHE  
THERMOS**





# POLARYS

## COLLECTION



### POLARYS FREEZE SZ

SZ30 • SZ40 • SZ50



### POLARYS FREEZE DZ

DZ35 • DZ45



### POLARYS PORTAFREEZE

8



### POLARYS TRAVEL

25 • 28





# POLARYS FREEZE

## SINGLE ZONE



**Nuovo frigo/congelatore bivalente portatile a scomparto unico dal design moderno e compatto. Dotato di resistente corpo in materiale plastico antiurto ad alta capacità isolante ed un display digitale per il controllo della temperatura. Ideale per camper, auto, imbarcazioni.**

### VANTAGGI:

- Spazioso, per conservare cibo e bevande per più persone
- Elevata velocità di raffreddamento
- Regolazione precisa mediante display digitale
- Design moderno e funzionale
- Ampio range temperatura
- Temperatura minima raggiungibile: -20°C
- Silenzioso, a basso consumo

### CARATTERISTICHE:

- Capacità: 30, 40, 50 l
- Voltaggio: 12V / 24V (DC), 220V (AC)
- Potenza totale Ingresso: 45W
- Tecnologia: Compressore

### PRESTAZIONI:

• Regolazione della temperatura	tra +20°C e -20°C (surgelamento)
• Refrigerante tipo	R1234yf
• GWP	1430
• Consumo medio di energia AC	(EN62552) 0,28 kWh/24h
• Consumo energetico 12V DC	(ambiente@32°C, interno@5°C) 1,29 Ah/h
• Classe climatica	(EN62552) T/ST/N/SN







30ℓ

**POLARYS FREEZE SZ 30**

Art. 0826052N

€ tbc  
1/1/6

60,3 x 36,5 x 37,2 cm

10,9 kg

12/24V DC - 100/240V AC

45W

30 l



40ℓ

**POLARYS FREEZE SZ 40**

Art. 0826053N

€ tbc  
1/1/6

60,3 x 36,5 x 44,2 cm

11,6 kg

12/24V DC - 100/240V AC

45W

40 l



50ℓ

**POLARYS FREEZE SZ 50**

Art. 0826054N

€ tbc  
1/1/6

60,3 x 36,5 x 51,2 cm

12,3 kg

12/24V DC - 100/240V AC

45W

50 l





# POLARYS PORTAFREEZE



8 l

## POLARYS PORTAFREEZE

Art. 0826047N

€ tbc  
1 / 1 / 18

23,6 x 39,3 x 44,3 cm

7,8 kg

AC 100-240V / DC 12/24V

8 l



ICE PACK



OPTIONAL BATTERY



**Frigorifero a compressore 12V/230V portatile concepito appositamente per l'utilizzo in spazi ridotti e per essere facilmente trasportato mediante il suo robusto maniglione pieghevole. Ideale per tutte le attività all'aperto, anche grazie alla possibilità di un'alimentazione mobile mediante l'utilizzo di una batteria al litio (opzionale). Costruzione solida e robusta realizzata con materiali di ottima qualità. Dotato di compressore di ultima generazione che ottimizza il rapporto tra consumo energetico e prestazione raffreddante.**

### CARATTERISTICHE:

- Batteria staccabile (opzionale) della durata di 4-24 ore
- Compressore di alta qualità per prestazioni di raffreddamento di alto livello
- Protezione della batteria a tre stadi
- Funzionamento DC/AC (AC con alimentatore esterno)
- Design durevole ed antiurto
- Display LCD
- Funzionamento silenzioso
- Maniglione per il trasporto pieghevole

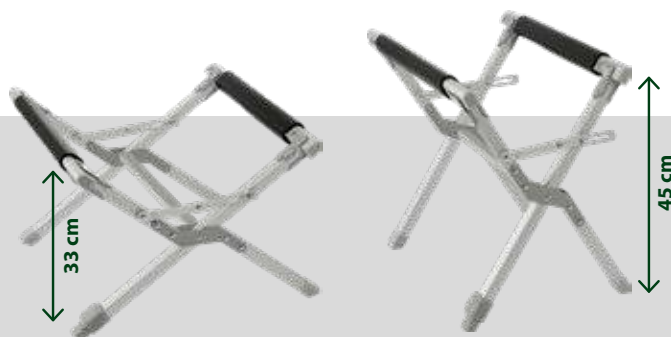

## OPTIONAL

### POLARYS E-PACK 15

Art. 0826043N

€ tbc  
1 / 1 / -

15600 mAh / 173 Wh

Con la batteria ricaricabile agli ioni di litio E-Pack 15, entrambi i frigobox a compressore della linea Polarys Freeze possono essere alimentati con energia mobile quando non è disponibile un'alimentazione convenzionale. A seconda del livello di refrigerazione, il contenuto dei frigobox viene mantenuto freddo fino a 8 ore.

Tensione: 11,1V  
Capacità: 15600 mAh/173 Wh  
Tensione di carica: 12,6V  
Tempo di ricarica: 8h ca.

### COOLER UP

Art. 0406047N

€ tbc  
1 / 1 / -

45 x 50 x H33/45 cm

63 x Ø 12 cm

1,5 kg

Telaio portafrigo pieghevole e regolabile su due altezze. Completo di custodia.





# POLARYS FREEZE

## DUAL ZONE

35ℓ



45ℓ



### POLARYS FREEZE DZ35

Art. 0826049N

€ tbc  
1/1/6

	64,7 x 44,1 x 40 cm
	15,6 kg
	12/24V DC - 100/240V AC
	60W
	35 l (25+10)

### POLARYS FREEZE DZ45

Art. 0826050N

€ tbc  
1/1/6

	64,7 x 50,5 x 40 cm
	16,5 kg
	12/24V DC - 100/240V AC
	60W
	45 l (32+13)

**Grazie ai nostri nuovi refrigeratori/congelatori Dual Zone potrete godervi l'estate in modo estremamente piacevole: Eccezionale capacità di raffreddamento e congelamento allo stesso tempo in un unico dispositivo! Due zone di temperatura regolabili separatamente (Dual Zone) e una batteria staccabile (opzionale) rendono i Polarys Freeze coolers i compagni ideali per tutte le attività all'aperto senza doversi preoccupare dell'alimentazione elettrica. In aggiunta, i refrigeratori/congelatori portatili Polarys Freeze vantano tutta una serie di caratteristiche interessanti e di funzioni utili:**

- Batteria staccabile (opzionale) della durata di 4-24 ore
- Due scomparti interni (Dual Zone) con controllo individuale della temperatura
- Compressore di alta qualità per prestazioni di raffreddamento di alto livello
- Protezione della batteria a tre stadi
- Uso DC/AC
- Design durevole ed antiurto
- Display LCD con controllo touch
- App per la regolazione della temperatura
- Funzionamento silenzioso
- Coperchio girevole che permette l'apertura da entrambi i lati
- Testato CE/RoHs
- La fornitura include: unità di raffreddamento, 1 cavo di collegamento CC, 1 cavo di collegamento CA, istruzioni per l'uso

#### PRESTAZIONI:

• Regolazione della temperatura	tra +20°C e -20°C (surgelamento)
• Refrigerante tipo	R1234yf
• GWP	1430
• Consumo medio di energia AC	(EN62552) 0,28 kWh/24h
• Consumo energetico 12V DC	(ambiente@32°C, interno@5°C) 1,29 Ah/h
• Classe climatica	(EN62552) T/ST/N/SN

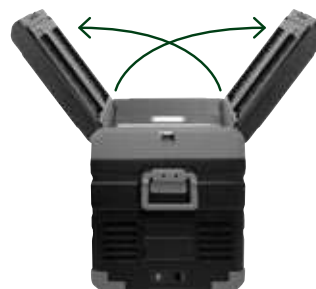

**REVERSE DOOR DESIGN MAKES DOOR OPENING MORE FLEXIBLE**



# POLARYS TRAVEL

25l



28l



F



## POLARYS TRAVEL 25

Art. 0826042N

€ tbc  
1 / 1 / 24

30 x 39 x H40,7 cm

4 kg

12V DC/230V AC

48 W

25l

**Frigobox termoelettrici (sistema Peltier), alimentati mediante accendisigari da auto 12V DC oppure da rete 230V AC. Leggero e facilmente trasportabile. Ideali per la spiaggia, il picnic ed il campeggio.**

### CARATTERISTICHE:

- Con cavo di collegamento per funzionamento a 12V o 230V
- Adatto per bottiglie da 1,5l / 2l
- Coperchio chiudibile con maniglia
- Coperchio elettrico con sistema di raffreddamento integrato
- Facile posizionamento del frigobox in quasi tutti i bauli delle auto o dietro il sedile del conducente o del passeggero

## POLARYS TRAVEL 28

Art. 0826044N

€ tbc  
1 / 1 / 28

30 x 39 x H45,7 cm

4,5 kg

12V DC/230V AC

48 W

28l



## OPTIONAL



### COOLPOWER

Art. 0826098N

€ tbc  
5 / 30 / -

13,5 x 5,5 x 3 cm

330 g

100V / 240V - 50/60Hz - AC

72W

Alimentatore 220/12V per frigobox termoelettrici. Tensione in entrata: 240V / 50Hz. Tensione in uscita 12V DC - 6A.



# GELBAG

## COLLECTION



### GELBAG 20

Art. 0824047N

€ tbc  
5 / 10 / -

36 x 23 x H31 cm

Polyester - PEVA

20 l

400 g



### GELBAG 30

Art. 0824048N

€ tbc  
5 / 10 / -

41 x 26 x H34 cm

Polyester - PEVA

30 l

450 g



### GELBAG 40

Art. 0824049N

€ tbc  
5 / 10 / -

45 x 30 x H36,5 cm

Polyester - PEVA

40 l

500 g



Sia che trascorriate il vostro tempo libero a un picnic, in spiaggia, in viaggio o a una festa, i nuovi Brunner Gelbag sono caratterizzati da un isolamento in schiuma di alta qualità che mantiene cibi e bevande piacevolmente freschi per molte ore. Il rivestimento interno, trattato con microbatteri, è facile da pulire in qualsiasi momento ed è altresì resistente alla formazione di odori, muffe e funghi.

#### CARATTERISTICHE:

- Design moderno e funzionale
- Parte anteriore con pratica daisy chain
- Schiuma di alta qualità per un efficace isolamento
- Ampio scomparto principale con cerniera per alimenti e bevande
- Tracolla regolabile per un comodo trasporto a mani libere
- Maniglie laterali imbottite
- Incluso apribottiglie
- Fodera interna trattata con antimicrobico per prevenire la formazione di odori, muffe e funghi





**AZOfree**

25ℓ



**NEOPRENE EVA**



## FREE GO 25

Art. 0824046N

€ tbc  
2 / 6 / 60

Borsa termica alla moda, perfetta per le calde giornate estive. Le bevande e gli alimenti rimangono piacevolmente freschi per un lungo periodo grazie ad uno strato isolante di alta qualità. La borsa termica Free Go è particolarmente resistenti e molto semplice da pulire dopo l'uso. Ideale per una fantastica giornata in spiaggia o un piacevole pic-nic in montagna.

48 x 23 x 32 cm

Tarpaulin 100% PVC / Alu Foil lining

25 l

820 g



BPAfree

PFOAfree



## ICE PACK 100

## ICE PACK 140

## COOLPAD 200

## COOLPAD 400

Mini mattonelle di ghiaccio sintetico con involucro in materiale plastico. Perfettamente adatte per mantenere freschi e trasportare cibi e bevande in borse termiche, ghiacciaie o contenitori alimentari in genere. Riutilizzabili senza limite. Non contengono metalli pesanti o ftalati.

Mattonella di ghiaccio sintetico dalla forma extra-piatta. Contenuto: refrigerante non pericoloso.



					PACK	€ tbc	M.O.	Master	
ICE PACK 100	Art. 0826017N	7,2 x 8,2 x 2 cm	80 ml	4x 100 g	4X	€ tbc	24	72	-
ICE PACK 140	Art. 0826016N	12 x 12 x 1,3 cm	120 ml	4x 140 g	4X	€ tbc	18	18	-
COOLPAD 200	Art. 0826018N	16,5 x 11 x H1,5 cm	200 ml	2x 180 g	2X	€ tbc	12	24	-
COOLPAD 400	Art. 0826019N	25 x 14 x H1,5 cm	400 ml	1x 375 g	1X	€ tbc	12	24	-



18ℓ



## SPECTRACOOL 18

Art. 0824038N.C9N

€ tbc  
6 / 6 / 90

33 x 21 x 29 cm

700D Nylon / Alu foil

18 l

1 kg



**AZOfree**

COLOR  
  
Assorted

Borsa termica ideale per le giornate in spiaggia.



25ℓ



## SPECTRACOOL 25

Art. 0824039N.C9N

€ tbc  
6 / 6 / 60

45 x 27 x 27 cm

700D Nylon / Alu foil

25 l

1,10 kg



**AZOfree**

COLOR  
  
Assorted

Borsa termica ideale per le giornate in spiaggia.



# FRIOBAG



12ℓ



20ℓ



30ℓ



34ℓ

Borse termiche di alta qualità, ideale per gite, spiaggia e picnic.





 **AZOfree**



## FRIOBAG COMPACT

Art. 0824041N





€ tbc  
10 / 10 / -

-  34 x 23 x 8,5 cm
-  100% Polyester Jacquard 420D
-  12l
-  250 g

## FRIOBAG DAYPACK

Art. 0824013N





€ tbc  
4 / 4 / -

-  30,5 x 18 x 46,5 cm
-  100% Polyester Jacquard 420D
-  20l
-  800 g

## FRIOBAG OBLIQUE

Art. 0824015N





€ tbc  
4 / 4 / 96

-  45 x 25 x 33 cm
-  100% Polyester Jacquard 420D
-  30l
-  850 g

## FRIOBAG CLASSIC

Art. 0824016N

€ tbc  
4 / 4 / -

-  34 x 31 x 33 cm
-  100% Polyester Jacquard 420D
-  34l
-  900 g





## FOSTER

Art. 0820028N

€ tbc  
6 / 24 / -

365 g

600 ml



## SHOT

Art. 0820055N

€ tbc  
12 / 24 / -

280 g

750 ml



## HYDROLIN STEEL 1000

Art. 0820026N

€ tbc  
6 / 24 / -

190 g

1000 ml



Bottiglia termica infrangibile realizzata in acciaio inox alimentare 18/8. 100% BPA-free.

Bottiglie portabevande in acciaio alimentare verniciato a polvere. Con tappo a vite a filetto interno e coperchio rivestito in elegante bambù. Inodore ed insapore. Lavabile in lavastoviglie.

Bottiglia in acciaio inox con elegante superficie lucidata.



## ZERO+ 5

Art. 0826002N

€ tbc  
2 / 6 / 60

25,2 x 26,6 x H27 cm

900 g

5 l

## ZERO+ 10

Art. 0826004N

€ tbc  
2 / 4 / 36

30,6 x 31,5 x H33,2 cm

1,65 kg

10 l

**Thermo-contenitore per bevande con tappo a vite e rubinetto. Design moderno.**

### CARATTERISTICHE:

- Adatto per bevande fredde e calde (max. 65°C)
- Apertura di riempimento di grandi dimensioni per riempimento e pulizia
- Coperchio filettato
- Utilizzabile anche come secchiello per il ghiaccio
- Rubinetto a tenuta



# INOX

Stainless Steel



## RICO

Art. 0820052N

€ tbc  
10 / 30 / -

400 g

500 ml

SOFT TOUCH



SILICON

**Bottiglia termica sottovuoto con coperchio a tazza.**

### CARATTERISTICHE:

- Isolamento sottovuoto a doppia parete
- Scocca esterna ed interna in acciaio inox
- Fondo antiscivolo (Antislip)
- Tappo a tenuta
- Versamento facile
- Coperchio a tazza incluso



## LEGEND OUTDOOR 500

Art. 0820050N

€ tbc  
12 / 24 / -

270 g

500 ml

## LEGEND OUTDOOR 1000

Art. 0820051N

€ tbc  
12 / 24 / -

470 g

1000 ml

Bottiglia termica realizzata interamente in acciaio inox antiurto.



## LIQUID

Art. 0820034N

€ tbc  
6 / 12 / -

Ø 11 x H31 cm

900 g

1,5 l

Bottiglia termica a doppia parete isolante realizzata in acciaio inox alimentare 18/8. 100% BPA-free.



# ELECTRICAL PRODUCTS



**PRODOTTI ELETTRICI AC E DC  
SPOT E PLAFONIERE  
ADATTATORI E PROLUNGHE**





**Invertitori di corrente per veicoli ricreazionali, auto, barche e sistemi ad energia alternativa. Inverter a onda sinusoidale modificata.**

**CARATTERISTICHE:**

- Tensione nominale in uscita: AC230V ± 10%
- Frequenza nominale in uscita: 50Hz ± 3Hz
- USB: 5V-3,1A
- Protezione tensione minima
- Protezione corto circuito

								M.O.	Master
ZING 300	Art. 0826060N	16 x 15,5 x 7,5 cm	868 g	10V-15V DC	300W	€ tbc	2	6	-
ZING 600	Art. 0826061N	19 x 15,5 x 7,5 cm	1 kg	10V-15V DC	600W	€ tbc	2	6	-
ZING 1200	Art. 0826062N	25,5 x 15,5 x 7,5 cm	1,5 kg	10V-15V DC	1200W	€ tbc	2	6	-

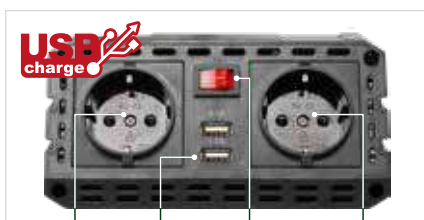

Ventola di raffreddamento Fusibile Collegamento cavi

Schuko USB: 5V-3,1A On / Off Schuko

Ventola di raffreddamento Collegamento cavi



**VENTO SWIFT 92**

Art. 7164006N

€ tbc  
6 / 12 / -

- 19,2 x 9,2 x 3 cm
- 350 g
- 12V - 0,5A



**VENTO NG 92**

Art. 7164011N

€ tbc  
6 / 12 / -

- 19,2 x 9,2 x 3 cm
- 350 g
- 12V - 0,5A

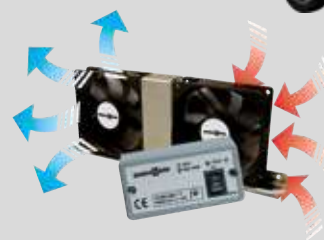

**VENTO ELECTRONIC**

Art. 7164010N



€ tbc  
6 / 12 / -

- 26 x 10 x 2,4 cm
- 370 g
- 12V - 0,5A
- 6W

**VENTO SWIFT 120**

Art. 7164007N

€ tbc  
6 / 12 / -

- 24,8 x 12 x 3 cm
- 460 g
- 12V - 0,5A

**VENTO NG 120**

Art. 7164012N

€ tbc  
6 / 12 / -

- 24,8 x 12 x 3 cm
- 460 g
- 12V - 0,5A

Con il Vento Swift, il ventilatore per frigoriferi è stato completamente reinventato. Il cablaggio del pannello di controllo è stato interamente eliminato e un semplice collegamento all'alimentazione a 12V di bordo è tutto ciò che serve per avviare il dispositivo. Il pannello di controllo, che è dotato di un display touch screen a batteria, consente di utilizzare comodamente tutte le impostazioni della ventola e può essere montato in modo flessibile in qualsiasi punto del veicolo. Il Vento Swift viene fornito completo di parti di montaggio.

Ventilatore per frigo ad alte prestazioni con pannello di controllo (completo di cornice per montaggio a parete). Il rilevamento della temperatura avviene mediante uno speciale sensore. Le staffe di fissaggio ed i cavi collegamento sono compresi nella fornitura.

Ventilatore per frigo a velocità variabile, regolata elettronicamente. Completo di pannello di comando.



App: W8 SYSTEM



# W8 2.0

Ø 31 cm



Smartphone not included



## W8 2.0

Art. 0712005N

€ tbc  
1 / 4 / -

Ø 29,2/31 x H3,2/4,1 cm

**La versione 2.0 della popolare W8-Gascontrol presenta i seguenti miglioramenti ed ottimizzazioni:**

- Nuova copertura sviluppata per le celle di carico
- Prolungamento dei cavi di collegamento al vano di ricarica della batteria
- App W8 rivisitata

Il dispositivo elettronico W8 GASCONTROL misura il livello di riempimento delle bombole a gas e lo trasmette via Bluetooth a Smartphone o Tablet con tecnologia Android o iOS. Grazie alla sua altezza molto contenuta il W8 GASCONTROL può essere utilizzato in maniera continuativa nel vano portabombole della stragrande maggioranza di veicoli ricreazionali.

### CARATTERISTICHE:

- Adatto per tutte le bombole gas (acciaio, alluminio, plastica, vetroresina) con diametro massimo di 30 cm
- Misurazione rapidissima del livello di riempimento
- Indicazione dell'autonomia
- Lettura del livello di riempimento e dell'autonomia su Smartphone o Tablet
- Tecnologia Bluetooth
- Software compatibile con sistemi Android e iOS
- App per Smartphone o Tablet inclusa (download)
- Funzionamento a batterie (non ricaricabili)
- Involucro in resistente materiale plastico
- Semplice e intuitivo da usare
- Prodotto europeo

### CAMPI D'UTILIZZO:

- Veicoli ricreazionali
- Camping e picnic
- Barbecue & grill

**ATTENZIONE: IL DISPOSITIVO DI LETTURA (SMARTPHONE, TABLET, ECC.) NON È INCLUSO NELLA FORNITURA!**



**4X1,5V AA batteries  
not included**

### BATTERY LEVEL

>75%

50%

<25%







WITH BUFFER BATTERY

### 3-SICUR

Art. 0712002N

€ tbc  
2 / 10 / -

7 x 11 x H4 cm



Dispositivo di rilevazione gas per veicoli ricreazionali dotato di sensore ad alta sensibilità in grado di rilevare propano/butano, monossido di carbonio e gas narcotizzanti. Il dispositivo si calibra automaticamente ed in caso di allarme emette un segnale acustico. Una batteria tampone (opzionale) garantisce la funzionalità del dispositivo anche in caso di mancanza di alimentazione di bordo. 3-Sicur, può essere utilizzato in modo mobile o con installazione permanente. E' dotato di un solo pulsante per accensione, spegnimento, test e reset, luci a led di segnalazione a led e spina a 12V.

## INFO

La versione 2.0 della popolare W8-Gascontrol presenta i seguenti miglioramenti ed ottimizzazioni:

- Nuova copertura sviluppata per le celle di carico
- Prolungamento dei cavi di collegamento al vano di ricarica della batteria
- App W8 rivisitata



Areas of application:



CARAVAN



MOTORHOME



BBQ





## MISTRAL UNIVERSAL

Art. 0716020N

€ tbc

4 / 12 / 96

Ø 22cm

0,7 kg

12V



Potente ventilatore a 12V con doppio sistema di fissaggio (piastra a vite o fissaggio a clip). Griglia di protezione cromata Ø 22cm. Collegamento elettrico tramite presa accendisigari.



## ATMO RG

Art. 0716014N

€ tbc

4 / 8 / -

Ø 22 x H13 cm

480 g

3,7V / 4000mAh RG Li-Ion

80 lumen

1

12h Light / 7h Fan



**Questa pratica combinazione di ventilatore/lampada ricaricabile fornisce simultaneamente una luce LED brillante e la brezza fresca di un potente ventilatore a quattro pale. Il design funzionale permette il fissaggio del ventilatore sia al tetto che alle pareti di tende e verande mediante la sua maniglia pieghevole e/o il suo gancio.**

### CARATTERISTICHE:

- 2 livelli di luminosità
- Ventilatore a 4 pale in schiuma espansa (a prova di infortunio) - 2 velocità
- Utilizzabile in 3 posizioni: appeso verticalmente, appeso orizzontalmente, appoggiato ad una superficie piana
- Batterie ricaricabili



## MONSUN

Art. 7202818N

€ tbc

6 / 12 / -

15 x 7 x H18 cm

18,5 x 7 x H10,5 cm

320 g

12V DC

180W

Utilissimo asciugacapelli 12V da viaggio. Design moderno con manico pieghevole salvaspazio. Involucro in resistente materiale plastico. Completo di interruttore ON/OFF, spina per accendisigari e becco per la piega staccabile. La fornitura comprende una pratica custodia per il trasporto.



## SCIROQUE 2.0

Art. 7202814N

€ tbc

6 / 24 / -

14,3 x 5 x 19 cm

300 g

220V + 110V AC

800W

Asciugacapelli compatto con maniglia pieghevole salvaspazio. Può essere utilizzato sia con una tensione di 230V, che con 110V. Corpo in resistente materiale plastico. Con pratica borsa portaoggetti.



## AIRTOUCH RG

Art. 0436011N

€ tbc  
5 / 10 / -



22,5 x 14 x H8 cm

1,34 kg

RG

8 bar - 120 PSI



**Compressore portatile wireless ricaricabile con batteria agli ioni di litio e presa USB per la ricarica. Dotato di display digitale Touch Screen. Ideale per essere utilizzato ovunque sia richiesto senza la necessità di avere nelle vicinanze una presa elettrica dove collegare il cavo di alimentazione. Perfetto per gonfiare auto, moto, biciclette e palloni.**

### CARATTERISTICHE:

- Corpo in resistente materiale plastico
- Display digitale
- Batteria agli ioni di litio 2500 mAh
- Presa USB per la ricarica
- Cavo di alimentazione/ricarica USB - lunghezza 1,5 m
- Con adattatore 5V DC / 1A
- Tubo aria in gomma con connettore a sgancio rapido. Lunghezza 60 cm
- Completo di 2 adattatori ed 1 ago sportivo



## INFLATOR

Art. 0436010N

€ tbc  
4 / 20 / -

12 x 10 x H11,5 cm

230 g

12V DC

75W

L/min 20 l/min

Gonfiatore e sgonfiatore elettrico 12V con interruttore ON/OFF completo di 3 adattatori.



## TEMPEST RG USB

Art. 0436016N

€ tbc  
10 / 20 / -

8 x 7,5 x 10,5 cm

280 g

RG

38 W

L/min 270 l/min

Potente pompa 5V con interruttore ON-OFF. Completa di adattatore USB. Con borsa.



RECHARGEABLE



## KERO THERMOSTAT

Art. 7202840N

€ tbc  
6 / 12 / -

15,5 x 15 x H7,3 cm

650 g

230V

500W DC



**Termoventilatore compatto in ceramica con elemento riscaldante PTC. Corpo in solido materiale plastico. Ideale per l'uso in caravan, camper o verande. Dotato di un regolatore termostatico. Il ventilatore integrato garantisce un'efficiente distribuzione del calore.**

### CARATTERISTICHE:

- Protezione anti-surriscaldamento
- Protezione anti-ribaltamento
- Controllo termostatico
- Adatto a locali fino a 10 m<sup>2</sup>



## SOLAN

Art. 7202839N

€ tbc  
6 / 6 / -

21 x 14 x 16 cm

1,5 kg

230V AC - 50Hz

750W / 1500W



**Potente stufetta elettrica a ceramica. Utilizzabile anche come ventilatore.**

### CARATTERISTICHE:

- Involucro in resistente materiale plastico
- Temperatura regolabile senza scatti
- Resistenze in ceramica PTC
- Non brucia la polvere
- Protezione anti-surriscaldamento
- Protezione anti-ribaltamento



## FERVOR

Art. 7202843N

€ tbc  
6 / 6 / -

25 x 7 x H37 cm

750 g

230V - 50Hz

400W / 800W



Efficiente stufa alogena a 2 livelli di potenza selezionabili tramite manopola.





## CALENSA

Art. 7202842N

€ tbc  
6/6/-



18 x 14 x 16,7 cm

255 g

230V

500W - 1000W



**Nuovissimo termoventilatore compatto in ceramica, con elemento riscaldante PTC. Corpo in solido materiale plastico, ideale per l'uso in caravan, camper o verande, è dotato di regolatore termostatico.**

### CARATTERISTICHE:

- Potenza variabile da 500 a 1000 Watt
- Termostato regolabile
- Fusibile di sicurezza
- Interruttore antiribaltamento
- Protezione da surriscaldamento



## BLACKFIRE NG

Art. 7202849N

€ tbc  
6/24/-



11,3 x 13,4 x H7,5 cm

410 g

12V

150W



Stufetta ad aria 12V.



WITH AUTOMATIC DETECTION OF THE INDUCTION COOKER, IT WILL NOT START WITHOUT IT



Induction



Touch Control

NEW 2023



Fornello elettrico portatile con doppia piastra ad induzione. Corpo in PP termoresistente e superficie di cottura realizzata in vetroceramica ad alta resistenza. Perfetta per l'utilizzo in ambito outdoor e camping grazie a due zone di cottura con 9 livelli di potenza (da 300 a 2000W) selezionabili mediante comandi Touch Control e display LED.

# HOT POINT

## HOT POINT INDUCTION

Art. 7202834N

€ tbc  
2/6/72

28 x 35 x H4,6 cm

2,1 kg

230V - 50Hz

300 - 2000W

Piastra ad induzione di calore portatile con corpo in PP e superficie di cottura realizzata in vetroceramica ad alta resistenza. Perfetta per l'utilizzo in ambito Outdoor e Camping grazie al suo peso ridotto ed ai 9 livelli di potenza (300 - 2000 W) selezionabili mediante interruttore Touch Control e display LED.



## HOT POINT INDUCTION DOUBLE

Art. 7202835N

€ tbc  
1/1/-

60 x 36 x H7 cm

4,5 kg

230V - 50Hz

300 - 2000W / 100 - 1500W



Touch Control



## HOT POINT

Art. 7202831N.C25

€ tbc  
6/6/-

29,5 x 27 x H7 cm + Plate Ø 18,5 cm

2 kg

230V - 50 Hz

750W

Piastra di cottura elettrica con corpo in metallo verniciato e manopola di selezione potenza a 5 posizioni.









## HOT POINT INDUCTION GRILL

Art. 7202833N

€ tbc  
1/1/-

 37 x 27 x H4,8 cm - 41,5 x 27,2 x H3,3 cm (grill plate)

 3,9 kg

 230V - 50Hz

 300 - 2000W



Fornello/Grill portatile elettrico dotato di monopiastra ad induzione. Costruzione solida e dal design moderno realizzata con corpo in PP termoresistente e superficie di cottura in vetroceramica ad alta resistenza. Ideale per l'utilizzo in ambito outdoor e campeggio, grazie a una zona di cottura con 9 livelli di potenza (da 300 a 2000W) selezionabili mediante comandi Touch control e display led. La fornitura comprende una piastra grill in alluminio predisposta per una termodiffusione omogenea, internamente rivestita in ceramica per delle cotture alla griglia davvero eccezionali.



## BOWA

Art. 7202847N

€ tbc  
10 / 10 / -

 600 g

 230V - 50Hz

 750W

 1 l

Bollitore acqua elettrico. Esecuzione cordless con grande indicatore di livello acqua.





# ASPAIR DUAL NG

## VACUUM CLEANER



13 min.



5,5 h



Charging



## ASPAIR DUAL NG

Art. 0436025N

€ tbc  
1 / 4 / -

12 x 41/122 x 12 cm

1 kg

Li-Ion 2000 mAh / 11,1 V

100 W / 5,5 kPa

500 ml (powder) / 120 ml (liquids)

13 min



**Il potente aspirapolvere Aspair Dual NG è lo strumento ideale per rimuovere qualsiasi tipo di sporco e/o liquido. Grazie al suo design molto maneggevole e compatto, è possibile pulire in poco tempo anche luoghi difficili da raggiungere. Piccoli e grandi residui di sporco vengono facilmente rimossi grazie alla sua grande potenza di aspirazione ed il vostro veicolo, la veranda o il tavolo da pranzo tornano puliti in pochissimo tempo. Utilizzabile perfettamente anche come aspirapolvere da pavimento per mezzo dei tubi di prolunga inclusi nella fornitura.**

### CARATTERISTICHE:

- Ricaricabile: Batteria Li-ion (funzionamento cordless) con indicatore di carica
- Potenza di aspirazione 5,5 kPa con potente motore a turbina
- Aspirazione a secco e a umido
- Facile da maneggiare grazie al peso ridotto di soli 1,0 kg
- Ricarica tramite caricatori 230V o cavo di ricarica 12V (180 cm)
- Filtro HEPA lavabile
- Pulizia a tutto campo: con 4 diversi tipi di accessori
- Inclusi nella fornitura: bocchetta per fessure, spazzola per pulire, spazzola rotonda, bocchetta per liquidi, tubi di prolunga, custodia per il trasporto
- Funzionamento silenzioso
- Capacità del contenitore di 500 ml di polvere o 120 ml di liquido
- Docking station (indipendente e a parete)

## VORTIX

Art. 0436020N

€ tbc  
6 / 12 / 72

Ø 22 x H24 cm

1,3 kg

12V

120W / 10A



Aspirapolvere ed aspira acqua a corrente continua con struttura in robusto materiale plastico, tubo flessibile e lungo cavo di alimentazione a 12V. Accessori inclusi: bocchetto per fessure, bocchetto per tappeti, adattore per gonfiaggio.







## ASPAIR COMPACT 12

Art. 0436026N

€ tbc  
1 / 12 / -

33,6 x 10,5 x 11,5 cm

645 g

12V

75W

500 ml



**Potente aspirapolvere 12V ideale per rimuovere qualsiasi tipo di sporco. Grazie ad un design maneggevole e compatto, è possibile pulire luoghi difficili da raggiungere. Piccoli e grandi residui di sporco saranno facilmente rimossi grazie alla sua potenza di aspirazione, così il vostro veicolo, la veranda o il tavolo da pranzo torneranno puliti in breve tempo.**

### CARATTERISTICHE:

- Alimentazione 12V
- Cavo di alimentazione 3 m con spina per accendisigari
- Potenza di aspirazione 5,5 kPa
- Filtro HEPA lavabile
- Pulizia a tutto campo grazie a diversi tipi di accessori
- Inclusi nella fornitura: bocchetta per fessura, spazzola per pulire, spazzola tonda, custodia per il trasporto

## DAYTONA DUO

Art. 7202854N

€ tbc  
1 / 1 / 12

56,5 x 35,5 x 61,5 cm

11 kg

230V - 50Hz

250W Washing + 120W Spinning

Questa lavatrice portatile dalle dimensioni compatte e dotata di centrifuga (sistema a doppia vasca) è ideale per lavare la biancheria in spazi compatti come in camper, in caravan o in un mobilhome. Caricamento dall'alto. Semplicemente selezionare la funzione desiderata (lavaggio o asciugatura) e la macchina si arresterà automaticamente non appena il ciclo sarà terminato. Corpo in resistente materiale plastico con coperchio trasparente. Capacità di carico: 3,5 kg in lavaggio (biancheria asciutta) e 1,5 kg in centrifuga. Basso consumo energetico.



## DAYTONA

Art. 7202853N

€ tbc  
1 / 1 / 16

35 x 36,5 x 50 cm

6 kg

230V - 50Hz

180W

Lavatrice portatile di dimensioni compatte con caricamento dall'alto. Dotata di un resistente involucro in materiale plastico, di un affidabile motore ed un pratico timer. Capacità di carico: 2 kg (biancheria asciutta). Basso consumo energetico.





## CONDO

Art. 7530024N

€ tbc  
5 / 100 / -

10,3 x 10,3 x 3,5 cm

80 g

12V

60 lumen

0,24W

Energy class  
in process of approval

Plafoniera LED rotonda. Con corpo in plastica, lente di diffusione ed interruttore ON/OFF. Montaggio a parete.



**White Light** **Red Light**



## ORION

Art. 7530003N

€ tbc  
5 / 60 / -

20,5 x 12,5 x 2,9 cm

110 g

12V

280 lumen

21 SMD

3,6W

**G**

Plafoniera LED ovale per interni con corpo in resistente materiale plastico ed interruttore ON/OFF. Montaggio a parete.

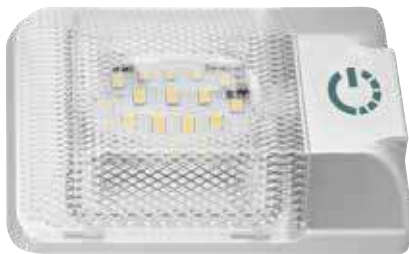

## AURIGA

Art. 7530006N

€ tbc  
5 / 60 / -

18 x 12 x 3,8 cm

110 g

12V

280 lumen

24

3,6W

**G**

Plafoniera con resistente involucro in ABS e lente in PP.



**On-Off  
Touch**



## LIBRA

Art. 7530007N

€ tbc  
5 / 60 / -

30 x 12,2 x 4 cm

210 g

12V

550 lumen

48

6W

**F**

Plafoniera con resistente involucro in ABS e lente in PP.





## ILUMINA LED 45

Art. 7530032N

€ tbc  
4 / 16 / -

45 x 3,8 x 4,2 cm

180 g

12 V

350 lumen

36

4,3W

## ILUMINA LED 60

Art. 7530033N

€ tbc  
4 / 16 / -

60 x 3,8 x 4,2 cm

280 g

12 V

630 lumen

66

6,7W



Luce esterna LED per illuminare l'ambiente circostante le porte d'entrata di veicoli ricreazionali. Il corpo realizzato interamente in alluminio, grazie alla sua speciale forma, facilita il deflusso dell'acqua piovana. Schermo in materiale plastico opacizzato per garantire la distribuzione uniforme della luce. Disponibile in 2 lunghezze.



## AVENUE

Art. 7530059N

€ tbc  
5 / 25 / -

37 x 5 x 5,5

280 g

12V

355 lumen

10

3W

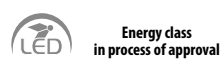

Lampada LED per esterni ad alta luminosità. Corpo in resistente ABS. Pre-cablati per un montaggio rapido. Angolo di diffusione: 40°.

## FUNKY LED HP

Art. 7530025N

€ tbc  
5 / 50 / -

Ø 6 x H10 cm

148 g

12V DC

140 lumen

1

3W



Energy class in process of approval

360° ROTATION 180° ADJUSTABLE

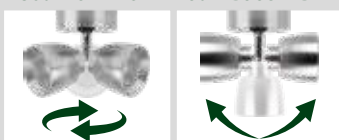

Spot LED montabile con riflettore orientabile.

## FLEXSPOT LED

Art. 7530028N

€ tbc  
5 / 50 / -

Ø 6,5 x H18 cm

190 g

10-30V

650 lumen

1

3W



G



Faretto LED da parete con braccio snodato (10 cm) realizzato in metallo cromato e riflettore in alluminio con interruttore sensibile al tatto. Design moderno ed elegante.



# AMBEL



## AMBEL COMPACT

Art. 7530026N

€ tbc  
6 / 12 / -

	50 x 2 x 1,5 cm
	125 g
	12V DC - 220V AC
	500 lumen
	30
	7W

Energy class  
in process of approval

La versione compatta della lampada Ambel L.

## AMBEL L

Art. 7530027N

€ tbc  
6 / 18 / -

	120,5 x 2,8 x 2,4 cm
	468 g
	12V DC - 220V AC
	1100 lumen
	180
	12W

Energy class  
in process of approval

Lampada tubolare LED per verande e gazebo. Montaggio ai pali della struttura mediante clips in plastica Ø 22-26 mm.

**DIMA TOUCH**  
**ON-OFF**  
**DIMMER 0-100%**



**SUPPORTS INCLUDED**



## RAY S

Art. 7530019N

€ tbc  
5 / 50 / -

	22,5 x 3 cm
	160 g
	12V DC
	150 lumen
	24
	2,5W

Energy class  
in process of approval



## RAY L

Art. 7530020N

€ tbc  
5 / 50 / -

	45 x 3,5 cm
	296 g
	12V DC
	500 lumen
	36
	5W

Energy class  
in process of approval

**MINI ROCKER**  
**SWITCH**



**180 DEGREE**  
**SWIVEL**

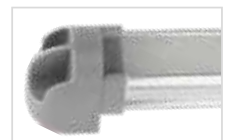

Lampada LED molto luminosa.  
Struttura in alluminio rotante.





## GLOBE LED

Art. 0720009N

€ tbc

10 / 50 / -

3,7V 2400mAh

98-394 lumen

8-15 h

42

Ø 10,4 x H17,3 cm

180 g

21W

Energy class  
in process of approval

Lampada LED a basso consumo energetico realizzata con corpo in resistente ABS e schermo in materiale plastico trans lucente che genera una luce uniforme. Il pulsante ON-OFF integrato permette di selezionare più livelli di intensità luce per illuminare l'ambiente circostante in maniera ottimale. Completa di gancio in metallo per appenderla e presa Micro-USB per la ricarica. Facile da trasportare grazie alle sue dimensioni compatte. Ottima per l'utilizzo Outdoor e Camping.

**RECHARGEABLE**

## ATHOME

Art. 7530031N

€ tbc

10 / 100 / -

12 x 4,3 x 1,7 cm

80 g

Lithium 500mAH 3,7V

240 lumen

12

0,75W

Energy class  
in process of approval

Lampada ricaricabile LED per armadi, entrate, corridoi, dispense, ecc. Corpo in elegante materiale plastico con sensore di movimento a tecnologia PIR integrato. Facilmente ricaricabile mediante presa USB. Montaggio a parete.

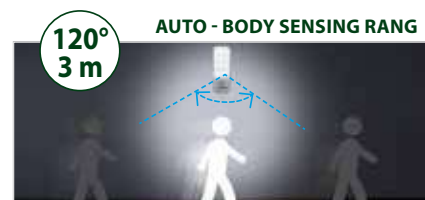
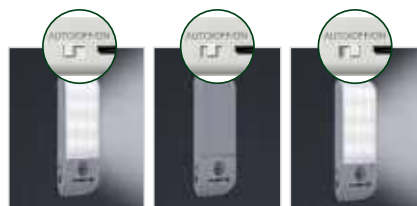

### 3 LIGHTING MODES

**AUTO**  
Motion Sensor  
Light

**OFF**  
Turn Light Off

**ON**  
Always Lighting





## SIXRAY

Art. 7521011N

€ tbc  
6 / 6 / -

Ø 50 x H25 cm

400 g

230V AC

250 lumen

5W

3h

Lampadario ad ombrello a sei raggi completo di lampadina LED a bulbo con batteria ricaricabile integrata. Completo di cavo di collegamento e interruttore ON/OFF.



LED **F** COLORS C06 C21 C30



**DIMMERABLE  
0-100%**

## SYRMA LED

Art. 7521018N

€ tbc  
5 / 20 / -

Ø 18,5 X H12 cm

350 g

230 V

520 lumen

32

15W

**Lampada LED per tende e verande. Corpo pieghevole in silicone (sistema Fold-Away).**

### CARATTERISTICHE:

- Corpo in silicone
- Moderna tecnologia LED per oscuramento graduale (dimmer)
- Con gancio di sospensione e cavo di collegamento da 5 m
- Sistema di regolazione dell'altezza
- Interruttore ON-OFF

LED **F** COLORS C06 C34





## ZAZÀ



## ZAZÀ DUO

Art. 0205081N

€ tbc  
6 / 12 / -
 230V AC

 11 x 6 x 4,5 cm

 60 g

not included



## ZAZÀ DUO 12V

Art. 0205083N

€ tbc  
6 / 6 / -
 9 x 5 x 4,5 cm

 80 g

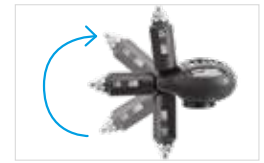
 12V DC

not included



Insetticida elettrico a vaporizzazione con doppia configurazione. Dotato di spina rotante e interruttore ON/OFF. Liquido non incluso.

Insetticida funzionante sia con piastrelle tampone che con pratico vaporizzatore per liquidi insettifughi (non inclusi). Non produce fumo e protegge per 8 ore ca.



## FIREFLY

Art. 0205085N

€ tbc  
4 / 16 / -
 13,1 x 13,1 x H13,6 cm

 600 g

 5V DC

 4W

**Zanzarikiller elettronico con lampada LED-UV e ventola di aspirazione incorporata.**

**CARATTERISTICHE:**

- Sicuro ed ecologico: nessun bisogno di repellenti anti-zanzare tossici e malsani
- Nessun odore sgradevole o sibilo fastidioso generato dai sistemi a scossa elettrica
- Zona di aspirazione a 360°: le zanzare vengono attratte dalla luce a LED ed aspirate nel corpo rimovibile tramite il ventilatore aspirante incorporato
- Funziona con una tensione di 5V DC con connessione USB
- Compatto e leggero. Facile da trasportare e posizionare

## 3in1





**WITH UV LIGHT  
360-390 nm**

## MOSLIGHT

Art. 0205086N

€ tbc  
6 / 24 / -
 8,7 x 8,7 x 13 cm

 230 g

 18650 RG (incl.)

 3W

**Praticissima lampada LED per Outdoor a doppia funzione luce/zanzarikiller dotata di batterie al litio ricaricabili. Utilizzabile anche appesa mediante il gancio in metallo pieghevole integrato nell'involucro. Schermo in materiale plastico translucido che trasmette una luce uniforme. Completa di cavetto USB di ricarica.**

**CARATTERISTICHE:**

- Funzionamento mediante batteria ricaricabile 18650
- Corpo in resistente materiale plastico ABS/PC
- Resistente agli spruzzi
- Zanzarikiller a luce UV (360-390 nm)
- Interruttore: ON-OFF (lampada)
- Interruttore ON-OFF (zanzarikiller)
- Luce a 3 intensità selezionabili
- Presa Micro-USB



## UNIVERSAL PLUG 10A

Art. 7203341N

€ tbc  
10 / 100 / 20

12V - 10A

Spina universale 12V. Completa di fusibile di sicurezza integrato.

## UNIVERSAL PLUG 15A

Art. 7203342N

€ tbc  
10 / 100 / -

12V - 15A

## PROLONGER 12V

Art. 0722083N

€ tbc  
12 / 48 / -

12V

Cavo di prolunga con spina universale 12V. Fusibile da 10A. Lunghezza cavo: 3 m



## SPIRAL PROLONGER 12V

Art. 0722084N

€ tbc  
12 / 48 / -

12V

Cavo di prolunga a spirale con spina universale 12V. Fusibile da 5A. Lunghezza cavo: 2 m



## TWIN CONNECT

Art. 7203356N

€ tbc  
6 / 24 / -

12V

Connettore doppio 12V con due prese per spine accendisigari. Fusibile da 10A.



## TWIN CONTROL

Art. 7203357N

€ tbc  
6 / 24 / -

12V

Connettore doppio 12V con controllo batteria. Fusibile da 10A.

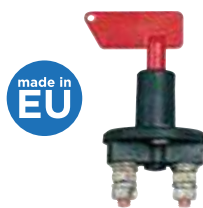

## B-SWITCH 12V

Art. 7203307C

€ tbc  
6 / 12 / -

12V

PACK 1X

Staccabatteria 12V/24V per veicoli ricreazionali ed autovetture. Resistenza fino a 500 A. Chiave estraibile.



## B-OFF 12V

Art. 7203312C

€ tbc  
6 / 12 / -

PACK 1X

Art. 7203312N

PACK -

€ tbc  
10 / 50 / -

12V

Staccabatteria 12V monopolo per veicoli ricreazionali ed autovetture.



## PLUG 13 P

Art. 7203545C

€ tbc  
8 / 8 / -

PACK 1X

Presse a 13 poli. Contatti nickel.



## RECEPTACLE 13 P

Art. 7203591C

€ tbc  
12 / 12 / -

PACK 1X

Presse a 13 poli. Con distacco automatico per luce antinebbia.



## CAPTOR 13/7

Art. 7203593C

€ tbc  
5 / 10 / -

PACK 1X

Adattatore da prese 13 poli (veicolo) a prese 7 poli (rimorchio).



## CAPTOR 7/13

Art. 7203595C

€ tbc  
5 / 10 / -

PACK 1X

Adattatore da prese 7 poli (veicolo) a prese 13 poli (rimorchio).



# PROLONGER



## PROLONGER CEE/CEE RUBBER

Cavo di prolunga CEE/CEE. Guaina in gomma. 230V-16A.

Art.	Lunghezza	Prezzo	1,5 mm <sup>2</sup>		2,5 mm <sup>2</sup>	
			M.O.	Master	M.O.	Master
Art. 0301091C	10 m	€ tbc	5	10	-	-
Art. 0301092C	25 m	€ tbc	4	4	-	-
Art. 0301095N	50 m	€ tbc	2	2	-	-
Art. 0301122C	5 m	€ tbc	6	6	-	-
Art. 0301093C	10 m	€ tbc	6	6	-	-
Art. 0301096C	15 m	€ tbc	6	6	-	-
Art. 0301094C	25 m	€ tbc	4	4	-	-



## PROLONGER SCHUKO/SCHUKO

Cavo di prolunga Schuko/Schuko. Guaina in gomma. 230V-16A.

Art.	Lunghezza	Prezzo	1,5 mm <sup>2</sup>		2,5 mm <sup>2</sup>	
			M.O.	Master	M.O.	Master
Art. 0301111C	10 m	€ tbc	6	6	-	-
Art. 0301112C	25 m	€ tbc	4	4	-	-
Art. 0301123C	5 m	€ tbc	6	6	-	-
Art. 0301108C	10 m	€ tbc	6	6	-	-
Art. 0301109C	25 m	€ tbc	4	4	-	-



## PROLONGER CEE/SCHUKO RUBBER

Cavo di prolunga CEE/Schuko. Guaina in gomma. 230V-16A.

Art.	Lunghezza	Prezzo	1,5 mm <sup>2</sup>		2,5 mm <sup>2</sup>	
			M.O.	Master	M.O.	Master
Art. 0301126C	5 m	€ tbc	6	6	-	-
Art. 0301127C	10 m	€ tbc	6	6	-	-
Art. 0301128C	15 m	€ tbc	6	6	-	-
Art. 0301115C	25 m	€ tbc	4	4	-	-
Art. 0301116C	25 m	€ tbc	4	4	-	-



## DRUMMER RUBBER 3X1,5

Art. 0301068N

€ tbc  
2 / 2 / 20

25 m / 3x1,5 mm<sup>2</sup>

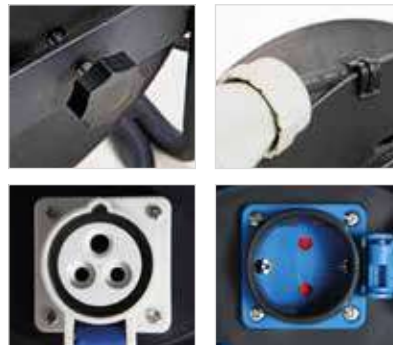

## DRUMMER RUBBER 3X2,5

Art. 0301081N

€ tbc  
2 / 2 / -

25 m / 3x2,5 mm<sup>2</sup>



Avvolgicavo CEE (guaina in gomma) dotato di 2 prese Schuko / 1 presa CEE con coperchio e protezione da sovraccarico.



## WHEELA

Art. 0301079N

€ tbc  
6 / 6 / 72

Ø35,5 x 10,5 cm



Avvolgicavo di alta qualità realizzato in robusto polipropilene. Leggero e funzionale, adatto a tutti i cavi elettrici con una lunghezza fino a 25 metri. Utilizzo semplice ed intuitivo, ideale per caravan, camper e motorhome.



# ADAPTOR



## ADAPTOR CEE/SCHUKO • 30 CM

Art. 0301076C

€ tbc  
10 / 40 / -

PACK 1X

30 cm / 3x1,5 mm<sup>2</sup>



Art. 0301090C

€ tbc  
10 / 40 / -

PACK 1X

30 cm / 3x2,5 mm<sup>2</sup>



Adattatore CEE/Schuko per esterni. Omologato CE 230V-16A. Cavo in gomma.



## ADAPTOR SCHUKO/CEE 90 • 30 CM

Art. 0301082C

€ tbc  
10 / 40 / -

PACK 1X

30 cm / 3x2,5 mm<sup>2</sup>



Adattatore Schuko/CEE. Omologato CE 230V-16A. Cavo in gomma.



## ADAPTOR CEE/CEE 90 • 150 CM

Art. 0301084C

€ tbc  
5 / 25 / -

PACK 1X

150 cm / 3x2,5 mm<sup>2</sup>



Adattatore CEE/CEE a gomito per esterni. Omologato CE 230V-16A. Cavo in gomma.



## ADAPTOR CEE/SCHUKO 150 CM

Art. 0301070C

€ tbc  
5 / 25 / -

PACK 1X

150 cm / 3x1,5 mm<sup>2</sup>



Art. 0301088C

€ tbc  
5 / 25 / -

PACK 1X

150 cm / 3x2,5 mm<sup>2</sup>



Adattatore CEE/Schuko per esterni. Omologato CE 230V-16A. Cavo in gomma.



## ADAPTOR SCHUKO/CEE 150 CM

Art. 0301071C

€ tbc  
5 / 25 / -

PACK 1X

150 cm / 3x1,5 mm<sup>2</sup>



Art. 0301086C

€ tbc  
5 / 25 / -

PACK 1X

150 cm / 3x2,5 mm<sup>2</sup>



Adattatore Schuko/CEE per esterni. Omologato CE 230V-16A. Cavo in gomma.



## ADAPTOR SCHUKO/CEE 90 • 150 CM

Art. 0301073C

€ tbc  
5 / 25 / -

PACK 1X

150 cm / 3x1,5 mm<sup>2</sup>



Art. 0301085C

€ tbc  
5 / 25 / -

PACK 1X

150 cm / 3x2,5 mm<sup>2</sup>



Adattatore Schuko/CEE a gomito per esterni. Omologato CE 230V-16A. Cavo in gomma.



### ADAPTOR CEE/SCHUKO

Art. 7203318C

€ tbc  
6/6/-

PACK 1X

Adattatore CEE/Schuko con presa bipasso. Omologato CE per uso temporaneo.

### PLUG CEE 90

Art. 7203452C

€ tbc  
8/8/-

PACK 1X

Presa a gomito CEE con coperchio. Tre poli. Con presa Schuko posteriore.



### COUPLER CEE 16A-230V

Art. 7203538C

€ tbc  
10/10/-

PACK 1X

Presa volante CEE 16A-230V.

### PLUG CEE 16A-230V

Art. 7203540C

€ tbc  
6/6/-

PACK 1X

Spina volante CEE 16A-230V.



## ELECTRO SAFE



### ELECTRO SAFE

Art. 7203438N

€ tbc  
6/24/-

Ø 87 x 210 mm

Contenitore di protezione antispruzzo in materiale plastico per raccordi Schuko.



### ELECTRO SAFE CEE

Art. 7203437N

€ tbc  
6/24/-

Ø 94 x 375 mm

Contenitore di protezione antispruzzo in materiale plastico per raccordi CEE.





# WATER AND SANITATION



**GHIRBE  
DOCCE  
ACCESSORI VR  
PRODOTTI CHIMICI**

# WEDOR



Standard  
DIN 96



## WEDOR CHH 22

Art. 0810055N

€ tbc  
1 / 1 / 24

 32 x 27 x 53/87 cm

 3,7 kg

- Serbatoio mobile per acque grigie 22l.
- Realizzato in resistente materiale plastico HDPE
  - Compatto e leggero
  - Maniglia di trasporto pieghevole
  - Con indicatore di livello e manicotto di scarico
  - Grandi ruote facilitano il trasporto
  - Completo di scarico e coperchi a vite



## WEDOR CHH 40

Art. 0810057N

€ tbc  
1 / 1 / 18

 37,5 x 23 x 80 cm

 40l

- Serbatoio mobile per acqua potabile 40l.
- Realizzato in resistente materiale plastico HDPE
  - Compatto e leggero
  - Maniglia di trasporto integrata
  - Grandi ruote facilitano il trasporto
  - Completo di tubo di scarico e coperchi a vite



## FUNNEL

Art. 0810032N

€ tbc  
12 / 72 / -

 Ø 14 x 40 cm

Imbuto in plastica con filtro integrato. Con trasvasatore flessibile.



### MANTIX

Art. 0810042N

€ tbc  
6 / 12 / -

✓ 9,4l



Ghirba a maniche in robusta plastica alimentare.



### CUBE 10

Art. 0810021N

€ tbc  
6 / 24 / -

✓ 10l

### CUBE 15

Art. 0810022N

€ tbc  
6 / 24 / -

✓ 15l

Ghirba pieghevole in robusta plastica alimentare. Con foro per appenderla e rubinetto regolabile ON/OFF.



### WABOX 10

Art. 0810005N

€ tbc  
5 / 20 / -

✓ 10l

### WABOX 15

Art. 0810006N

€ tbc  
5 / 20 / -

✓ 15l

Ghirba pieghevole in morbido materiale plastico alimentare.



### ALEA 8

Art. 0810070N

€ tbc  
6 / 12 / -

✓ 8l

### ALEA 16

Art. 0810071N

€ tbc  
6 / 24 / -

✓ 16l

Ghirba a fisarmonica in plastica alimentare.

## FOLDAWAY



HEAT RESISTANT  
40°C



### BLUE PEARL

Art. 0810010N

€ tbc  
12 / 24 / -

✓ 5,5l

Ø 19 x 11/25,6 cm

Contenitore d'acqua pieghevole in materiale plastico di alta qualità.

# JERRY



### JERRY PLUS

Ghirba in robusta plastica alimentare. Con foro per appenderla e rubinetto regolabile ON/OFF.

### JERRY PRO

Taniche acqua portatili per Outdoor e camping. Caratterizzate da un grande tappo a vite e da un rubinetto ON/OFF. Realizzate in robusto polietilene alimentare.



✓

M.O.

Master



JERRY PLUS 10	Art. 0810063N	10l	€ tbc	10	10	80
JERRY PLUS 20	Art. 0810064N	20l	€ tbc	6	6	80
JERRY PRO 15	Art. 0810073N	15l	€ tbc	6	6	48
JERRY PRO 20	Art. 0810074N	20l	€ tbc	6	6	48



# AQUATIC



EASY  
INSTALLATION



## AQUATIC 10L

Art. 7202415C

€ tbc  
5 / 25 / -

100 x Ø 38 mm

140 g

12V DC

l/min 10 l/min

PACK 1X

Pompa acqua ad immersione. Pressione: 0,6 bar. Completa di 90 cm di cavo elettrico di collegamento.



## AQUATIC 18L

Art. 7202418C

€ tbc  
5 / 15 / -

110 x Ø 64 mm

260 g

12V DC

l/min 18 l/min

PACK 1X

Pompa acqua ad immersione con dispositivo di sfiato automatico. Pressione: 1,0 bar. Completa di 90 cm di cavo elettrico di collegamento.



## AQUATIC 22L

Art. 7202419N

€ tbc  
15 / 60 / -

53 x 77 x 130 mm

290 g

12V DC

l/min 22 l/min

Potente pompa ad immersione con valvola di non ritorno e sfiato automatico. Involucro in ABS. Uso universale per bagno e cucina. Pressione: 1,4 bar. Cavo di collegamento da 100 cm.



## FONTAY

Art. 7202413N C00

€ tbc  
10 / 80 / -

125 g

12V - 3A

COLOR

C00 C37

Rubinetto ad erogazione automatica. Con interruttore microswitch 12V-3A. Pressione massima: 2,5 bar. Foro di montaggio: Ø 19 mm



PHTHALATE free

## SOLAR PHF

Art. 0810018N

€ tbc  
6 / 24 / -

V 20 l



## SPLASH

Art. 0810023N

€ tbc  
6 / 12 / 72

V 15 l



Doccia solare in PVC atossico con flusso acqua regolabile e maniglia per appenderla.

Doccia a pressione. Con pompa a pedale e sacchetto custodia.



## AQUAFRESH 2.0

Art. 0810013N

€ tbc  
6 / 12 / -

2 kg

12V DC - 35W

l/min 3,5 l/min.

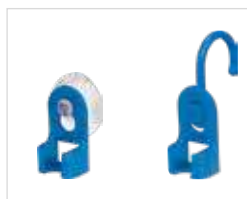

## FLUX RG

Art. 0810014N

€ tbc  
6 / 12 / -

620 g

2200mAh Li-Ion RG

l/min 4 l/min

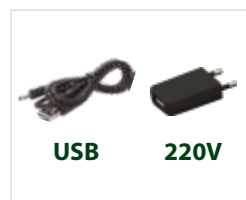

Doccia da viaggio a 12V per taniche d'acqua. Design moderno abbinato a prestazioni migliorate. Ideale per fare la doccia, per pulire il veicolo e/o la bicicletta o per risciacquare i piatti dopo i pasti. Design robusto e compatto. La fornitura contiene: doccetta con tubo flessibile 2m, pompa ad immersione 12V, ventosa per soffione doccia, cavo di collegamento (5m) con spina accendisigari 12V, borsa custodia.

**Doccia Outdoor ricaricabile con interruttore ON/OFF. Leggera e senza fili. Ideale per camping, spiaggia, caravaning ed altre attività Outdoor.**

### CARATTERISTICHE:

- Funzionamento One-Touch
- Ricarica batterie mediante cavo USB
- Funzionamento con batteria al litio integrata



NEW  
2023



## OPTIPOT

Art. 0402028N

€ tbc  
6 / 6 / -

31 x 31 x H37 cm

1,0 kg

23,5 l

WC portatile a secchio con tavoletta, coperchio e maniglia per il trasporto. Costruzione robusta e stabile in materiale plastico. Compatto e facile da trasportare rappresenta una soluzione pratica e conveniente in ambito outdoor e camping.



## OPTITOIL

Art. 0402023N

€ tbc  
1 / 1 / -

40 x 48 x H33 cm

2,4 kg

7 l

Moderna toilette portatile con seduta, coperchio e secchio chiudibile separatamente.



360°



## OPTILOO

Art. 0402030N

€ tbc  
1 / 1 / 16

39 x 41,5 x H43 cm

2,4 kg

7 l

**Moderno WC portatile con comoda altezza di seduta.**

### CARATTERISTICHE:

- Sedile e coperchio possono essere aperti e chiusi separatamente
- Secchio estraibile con coperchio
- Supporto per carta igienica
- Costruzione robusta fatta in resistente PP
- Design moderno

## OPTIBAG

Art. 0402037N

€ tbc  
10 / 20 / -

PACK 25X



**BIO- DEGRADABLE**

Sacchetti in plastica biodegradabile e compostabile per WC portatili.

## WC-MASK

Art. 0402031N

€ tbc  
20 / 160 / -



**BIO- DEGRADABLE  
DISSOLVABLE IN WATER**



Coprisedile igienico per WC in carta dissolvente. Confezione da 20 pezzi.

**BRUNER**





## ROLL ON 2.0

Art. 7203132N

€ tbc  
5 / 5 / 30

Ø 40 x H48 cm + tube 15 m

Avvolgitubo di nuova concezione con tubo piatto flessibile, resistente alla torsione e ad uso alimentare (costruzione a 3 camere), che in fase di utilizzo può essere srotolato solo fino alla lunghezza necessaria. Gli attacchi rapidi e la lancia sono inclusi nella fornitura.



## AQUAFIL PRO

Art. 7203133N

€ tbc  
6 / 6 / 72

28 x 15 x H30 cm + tube 11,6 m

3/4"

Nuovo avvolgitubo dalle dimensioni compatte ideale per riempire i serbatoi o il lavaggio del veicolo, ma anche utilissimo per irrigare piante e fiori durante il soggiorno in campeggio. Involucro in resistente materiale plastico con maniglione integrato.

La fornitura comprende:

- 11,6 m di tubo flessibile alimentare Ø 7,9 mm (10 m interni + 1,6 m esterni di collegamento)
- lancia ergonomica a portata variabile "3 JET"



## FELIX

Art. 7203135N

€ tbc  
9 / 36 / -

tube 9 m

Tubo rifornimento acqua piatto, con guaina resistente a strappi e lacerazioni. Completo di raccordi.



## HELIX

Art. 7203134N

€ tbc  
10 / 10 / -

40 x 34 cm + tube 15 m

Avvolgitubo con tubo piatto dotato di guaina in tessuto antimangiatura. Completo di raccordi e lancia per doccia a quattro posizioni.



## AQUAFIL

Art. 7203138N

€ tbc  
2 / 6 / -

27,5 x 15,5 x 13,5 cm + tube 10 m

3/8"

Avvolgitubo portatile con tubo in PVC alimentare da 3/8" e 2 raccordi rapidi. Struttura in resistente materiale plastico. Completo di lancia. Lunghezza tubo: 10 m.

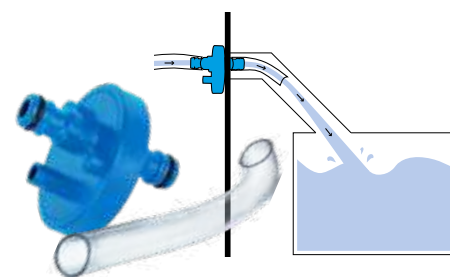

## HYDOCK 67

Art. 7203140N € tbc  
10 / 120 / -

Ø 67mm (2-pin)

Tappo di riempimento del serbatoio dell'acqua potabile con pratico attacco rapido. Connessione semplice e intuitiva tramite attacco a baionetta con diametro di 67 mm (2 pin) o 77 mm (3 pin). Realizzato in resistente plastica alimentare. Assicura il riempimento igienico e sicuro del serbatoio dell'acqua potabile.

## HYDOCK 77

Art. 7203145N € tbc  
10 / 120 / -

Ø 77mm (3-pin)

# HYNECT

## HYNECT S

Art. 7203144C € tbc  
16 / 16 / -

3/4"



Manicotto per raccordare tubi di gomma alle cannelles lisce.



## HYNECT T

Art. 7203141C € tbc  
16 / 16 / -

1/2"



**BEST  
SELLER**



105 - 175 cm

## FLIZ

Art. 7203153N

€ tbc  
12 / 12 / -

105 - 175 cm

720 g



115 - 180 cm

## MOPPY

Art. 7203156N

€ tbc  
8 / 8 / -

115 - 180 cm

780 g



140 - 240 cm

METAL



EXTRA STRONG

## WOSH

Art. 7203150N

€ tbc  
8 / 8 / -

140 - 240 cm

1,46 kg

Idrospazzola con manico telescopico in alluminio, manopole in espanso e spazzola filettata con setole delicate. Larghezza spazzola 25 cm. Con attacco rapido.

Spazzola telescopica per lavaggio veicoli con manico in alluminio e raccordo rapido.

Spazzola di lavaggio telescopica a connessione rapida e con interruttore ON/OFF.



## POPY

Art. 0402042N

€ tbc  
6 / 24 / -

Ø 9 x 32 cm

Spazzolino per WC in materiale plastico.



## TOBY

Art. 0402046N

€ tbc  
10 / 40 / -

8 x 25,5 cm

Spazzolino WC di dimensioni molto compatte. Montaggio a parete.



Silicon

## TOBY SK

Art. 0402044N

€ tbc  
10 / 40 / -

8 x 25,5 cm

Spazzolino WC di dimensioni molto compatte con setole in silicone.





# TENT

## CARE & MAINTENANCE



### NYLON/ POLYESTER

Art. 0205014N

€ tbc  
12 / 12 / -

✓ 500 ml

Impermeabilizzante per tessuti in nylon o poliestere. Azione idrorepellente, anti-deterioramento ed antimuffa.



### SYNTHETIC

Art. 0205015N

€ tbc  
12 / 12 / -

✓ 500 ml

Impermeabilizzante per tessuti sintetici pesanti (verande-teloni, ecc.). Azione idrorepellente, antideterioramento ed antimuffa.



### COTTON

Art. 0205016N

€ tbc  
12 / 12 / -

✓ 500 ml

Impermeabilizzante per tessuti naturali. Azione idrorepellente, antideterioramento ed antimuffa.



### CLEANER

Art. 0205026N

€ tbc  
12 / 12 / -

✓ 500 ml

Detergente per tessuti naturali e sintetici. Rimuove lo sporco senza indebolire tessuto e fibre.



### SEALER

Art. 0202099N

€ tbc  
24 / 24 / -

✓ 100 ml

Sigillante per cuciture su tessuti naturali e sintetici. Trasparente, elastico e lavabile.



### ACTI-GUM

Art. 0205044N

✓ 100 ml

Gel lubrificante silconico per fessure, profili, guarnizioni, cerniere, pali tenda, ecc.



### ACTI-MAT REPAIR

Art. 0205027N

€ tbc  
24 / 24 / -

✓ 100 ml

Liquido riparatore sigillante per prodotti in PVC oppure neoprene come materassini, canotti, piccoli gommoni ed articoli gonfiabili in genere. Inodore, non contiene solventi.





# CAMPER/CARAVAN

## CARE & MAINTENANCE



### ACTI-FRESH

Art. 0205031N

€ tbc

14 / 14 / -

V 1000 ml

Liquido antifermentativo e deodorante per la rimozione/prevenzione di incrostazioni maleodoranti dai serbatoi di raccolta delle acque grigie.



### ACTI-TANK

Art. 0205033N

€ tbc

14 / 14 / -

V 1000 ml

Liquido disincrostante per la rimozione di incrostazioni inorganiche (calcare) ed organiche (alghie, batteri) da serbatoi e condutture.



### ACRYGLASS

Art. 0205012N

€ tbc

12 / 12 / -

V 500 ml

Detergente speciale per vetri acrilici. Rimuove insetti, nicotina, grasso, fuliggine, ecc. senza danneggiare il vetro.



### ACTI-WASH

Art. 0205030N

V 500 ml

Detergente superconcentrato per il lavaggio manuale della carrozzeria di camper, caravan ed autoveicoli.



### ACTI-CLEAN

Art. 0205045N

€ tbc

12 / 12 / -

V 500 ml

Detergente specifico per la rimozione da superfici in metallo e plastica di forti contaminazioni.



# TECHNIQUE



**COPERTURA E PROTEZIONI  
ACCESSORI VR**



# FLYNET MIDI



Zanzariera aggiuntiva con telaio in alluminio per il Dometic Midi Heki con funzionamento a manovella.

**Impedite la penetrazione di sporcizia ed insetti fastidiosi con la nuova zanzariera FLYNET di nuova concezione. Con FLYNET la protezione del vostro veicolo inizia già a livello del tetto ed il fastidioso deposito di mosche, zanzare e altri parassiti, ma anche di foglie, aghi di alberi, ecc. sulla zanzariera interna e sulla tendina oscurante viene completamente eliminato.**

**FLYNET utilizza un telaio in alluminio di alta qualità. Ciò consente un fissaggio rapido, semplice e permanente al Dometic Midi Heki (con manovella) senza la necessità di fastidiose forature e/o avvittamenti. Il telaio dell'obló Heki rimane completamente integro ed è visivamente migliorato. Se si desidera rimuovere la FLYNET per la pulizia o durante la pausa invernale, è sufficiente sollevarla ed estrarla.**

**CARATTERISTICHE:**

- Telaio in alluminio di peso ridotto ed elevata stabilità
- Zanzariera in tessuto di fibra di vetro resistente alle intemperie
- Aspetto di alto livello grazie al moderno profilo in alluminio con bordi arrotondati e spazzole laterali
- Montaggio senza forare e/o avvitare
- Pronta per l'uso
- Adatta per il Midi-Heki originale Dometic con funzionamento a manovella
- Prodotta in UE

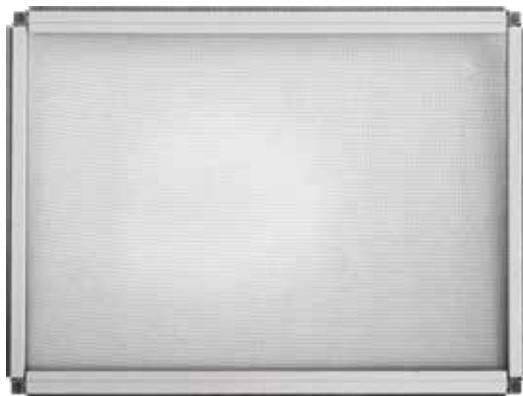

**FLYNET MIDI**

Art. 7232148N

€ tbc  
1 / 1 / -

62,5 x 46 x H1,4 cm  
 600g







# CAMPER COVER SI

## SEMI-INTEGRATED MOTORHOMES

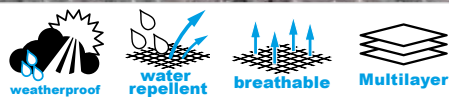

### CAMPER COVER SI 6M

Copertura protettiva per camper semi-integrati.

**CARATTERISTICHE:**

- Tessuto traspirante e idrorepellente
- Tessuto non tessuto a 4 strati
- Sviluppato per l'uso invernale



			M.O.	Master	
Art. 7241507N	600 - 650	€ tbc	1	1	12
Art. 7241508N	650 - 700	€ tbc	1	1	12
Art. 7241509N	700 - 750	€ tbc	1	1	12
Art. 7241510N	750 - 800	€ tbc	1	1	12

Art.	7241507N	7241508N	7241509N	7241510N
cover size in cm	650x240x250	700x240x250	750x240x250	800x240x250
Size A cm	650	700	750	800
Size B cm	240	240	240	240
Size C cm	250	250	250	250

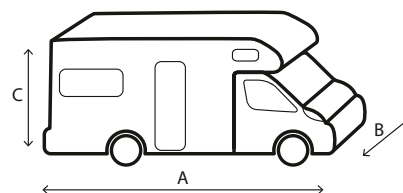

### STAND-OFF SET

Art. 7110120N

€ tbc  
4 / 4 / -

12 x 11,8 x 7,4 cm

22 g

PACK 4X



### CORNER GUARD SET

Art. 7110121N

€ tbc  
4 / 4 / -

27,4 x 17,6 x 6,9 cm

44 g

PACK 4X



Distanziatori per coperture di protezione in materiale schiumato EPP. Utilissimi per proteggere le parti esterne e le finestre del veicolo da sfregamenti ed abrasioni. Set 4 pezzi.

Protezioni angolari in resistente materiale schiumato EPP. Utilissime per bloccare le cinghie di tensionamento ed evitarne il contatto con i bordi inferiori del veicolo. Set 4 pezzi.

# CAMPER COVER

ALCOVE MOTORHOMES



weatherproof



water repellent



breathable



Multilayer

## CAMPER COVER 6M

WINTER PROTECTION 

Copertura protettiva per camper. Versione più larga e più alta. Tessuto TNT traspirante. Resistente ai raggi UV, idrorepellente e lavabile. Viene fornita in una comoda sacca custodia.



			M.O.	Master	
Art. 7241482N	500 - 550	€ tbc	1	1	12
Art. 7241484N	550 - 600	€ tbc	1	1	12
Art. 7241485N	600 - 650	€ tbc	1	1	12
Art. 7241486N	650 - 700	€ tbc	1	1	12
Art. 7241487N	700 - 750	€ tbc	1	1	12
Art. 7241488N	750 - 800	€ tbc	1	1	12
Art. 7241489N	800 - 850	€ tbc	1	1	12

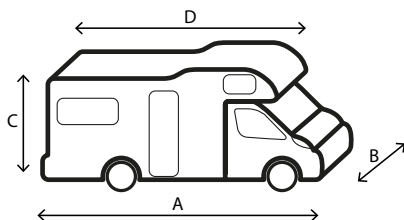

Art.	7241482N	7241484N	7241485N	7241486N	7241487N	7241488N	7241489N
cover size in cm	550x240x270	600x240x270	650x240x270	700x240x270	750x240x270	800x240x270	850x240x270
Size A cm	550	600	650	700	750	800	850
Size B cm	240	240	240	240	240	240	240
Size C cm	270	270	270	270	270	270	270
Size D cm	495	545	595	645	695	745	795



## INFO

WINTER PROTECTION 

### I materiali utilizzati per il tetto:

Tessuto non tessuto simile alla carta realizzato con microfilamenti di polietilene ad alta densità (PE-HD). Ideale per coperture all'aperto.

- Ottima resistenza chimica
- Resistente all'abrasione
- Traspirante
- Idrorepellente
- Permeabile al vapore acqueo
- Antivento

- Antistatico
- Non brucia, fonde a 135°C
- Flessibile anche con temperature < 0°C
- Precisione dimensionale
- Resistente agli strappi
- Range di temperatura: -75°C - + 80°C



# CARAVAN COVER

## WINTER PROTECTION

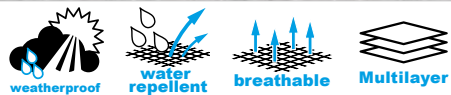

### CARAVAN COVER 6M

Copertura protettiva per caravan. Tessuto TNT traspirante. Resistente ai raggi UV, idrorepellente e lavabile. Viene fornita in una comoda sacca custodia.



			M.O.	Master	
Art. 7241460N	400 - 450	€ tbc	1	1	12
Art. 7241461N	450 - 500	€ tbc	1	1	12
Art. 7241462N	500 - 550	€ tbc	1	1	12
Art. 7241463N	550 - 600	€ tbc	1	1	12
Art. 7241464N	600 - 650	€ tbc	1	1	12
Art. 7241465N	650 - 700	€ tbc	1	1	12
Art. 7241466N	700 - 750	€ tbc	1	1	12
Art. 7241467N	750 - 800	€ tbc	1	1	12

Art.	7241460N	7241461N	7241462N	7241463N	7241464N	7241465N	7241466N	7241467N
cover size in cm	450x240x220	500x240x220	550x250x220	600x250x220	650x250x220	700x250x220	750x250x220	800x250x220
Size A cm	450	500	550	600	650	700	750	800
Size B cm	240	240	250	250	250	250	250	250
Size C cm	220	220	220	220	220	220	220	220
Size D cm	405	455	505	555	605	655	705	755

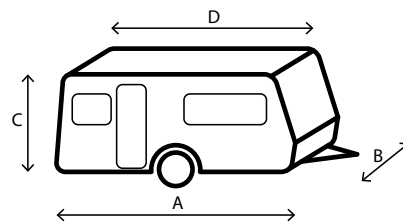



# TOP COVER

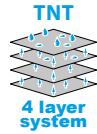

Funzionale copertura per tetti caravan. Realizzata in TNT a 4 strati traspirante ma idrorepellente. Dotato di pratica sacca custodia.

			M.O.	Master	
Art. 7241470N	400 - 450 x 390 cm	€ tbc	1	1	24
Art. 7241471N	450 - 500 x 390 cm	€ tbc	1	1	24
Art. 7241472N	500 - 550 x 390 cm	€ tbc	1	1	24
Art. 7241473N	550 - 600 x 390 cm	€ tbc	1	1	24
Art. 7241474N	600 - 650 x 390 cm	€ tbc	1	1	24
Art. 7241475N	650 - 700 x 390 cm	€ tbc	1	1	24
Art. 7241476N	700 - 750 x 390 cm	€ tbc	1	1	24
Art. 7241477N	750 - 800 x 390 cm	€ tbc	1	1	24

# PRO COVER

12M DUCATO

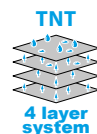

Copertura di protezione 12M a 4 strati realizzata appositamente per camper Ducato. Realizzata con materiali e finiture di ottima qualità che garantiscono un'efficace protezione del mezzo durante tutto l'anno. Disponibile in 3 misure.

			M.O.	Master	
Art. 7241457N	541 x 205 x H252 cm	€ tbc	1	1	12
Art. 7241458N	599 x 205 x H277 cm	€ tbc	1	1	12
Art. 7241459N	636 x 205 x H277 cm	€ tbc	1	1	12



# CAMPER COVER DESIGN

## SUMMER / WINTER PROTECTION

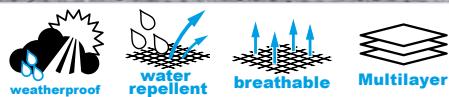

SUMMER / WINTER PROTECTION 



### CAMPER COVER DESIGN 12M



Art.	Size	Price	M.O.	Master	Icon
Art. 7241540N	500 - 550 cm	€ tbc	1	1	12
Art. 7241541N	550 - 600 cm	€ tbc	1	1	12
Art. 7241542N	600 - 650 cm	€ tbc	1	1	12
Art. 7241543N	650 - 700 cm	€ tbc	1	1	12
Art. 7241544N	700 - 750 cm	€ tbc	1	1	12
Art. 7241545N	750 - 800 cm	€ tbc	1	1	12
Art. 7241546N	800 - 850 cm	€ tbc	1	1	12

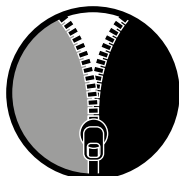

EQUIPPED WITH REAR ZIPS

Art.	7241540N	7241541N	7241542N	7241543N	7241544N	7241545N	7241546N
cover size in cm	550x240x270	600x240x270	650x240x270	700x240x270	750x240x270	800x240x270	850x240x270
Size A cm	550	600	650	700	750	800	850
Size B cm	240	240	240	240	240	240	240
Size C cm	270	270	270	270	270	270	270
Size D cm	495	545	595	645	695	745	795

Le coperture per camper della linea Design 12M fanno tesoro della nostra continua ricerca di soluzioni all'avanguardia e consolidano 5 anni di esperienza nella produzione unendola ad un nuovo design moderno e accattivante che si ispira alla veste grafica attualmente riscontrabile su molti veicoli ricreazionali.

#### CARATTERISTICHE:

- Tessuto in TNT antigraffio e traspirante a 4 strati resistente ai raggi UV
- Ottima protezione del mezzo da fattori esterni quali pioggia, sole, polvere, inquinamento chimico, escrementi animali, foglie, ecc
- Ottimo sistema di fissaggio antivento mediante robuste cinghie dotate di fibbia tensionatrice
- Dotate di cerniere laterali che permettono un comodo accesso al mezzo quando coperto
- Dotate di cerniere posteriori che facilitano notevolmente le operazioni di copertura e permettono l'accesso alla parte posteriore del mezzo quando coperto
- Complete di sacca custodia
- Colore: grigio chiaro/grigio scuro

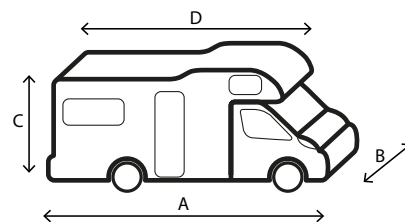

# CARAVAN COVER DESIGN

SUMMER / WINTER PROTECTION

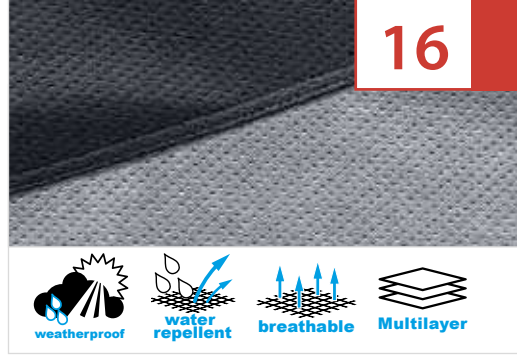

## CARAVAN COVER DESIGN 12M

				M.O.	Master
Art. 7241550N	400 - 450 cm	€ tbc	4	1	12
Art. 7241551N	450 - 500 cm	€ tbc	1	1	12
Art. 7241552N	500 - 550 cm	€ tbc	1	1	12
Art. 7241553N	550 - 600 cm	€ tbc	1	1	12
Art. 7241554N	600 - 650 cm	€ tbc	1	1	12
Art. 7241555N	650 - 700 cm	€ tbc	1	1	12
Art. 7241556N	700 - 750 cm	€ tbc	1	1	12
Art. 7241557N	750 - 800 cm	€ tbc	1	1	12



Art.	7241550N	7241551N	7241552N	7241553N	7241554N	7241555N	7241556N	7241557N
cover size in cm	450x240x220	500x240x220	550x250x220	600x250x220	650x250x220	700x250x220	750x250x220	800x250x220
Size A cm	450	500	550	600	650	700	750	800
Size B cm	240	240	250	250	250	250	250	250
Size C cm	220	220	220	220	220	220	220	220
Size D cm	405	455	505	555	605	655	705	755

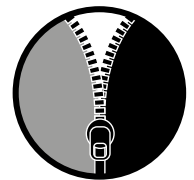

EQUIPPED WITH REAR ZIPS

Le coperture per caravan della linea Design 12M fanno tesoro della nostra continua ricerca di soluzioni all'avanguardia e consolidano 5 anni di esperienza nella produzione unendola ad un nuovo design moderno e accattivante che si ispira alla veste grafica attualmente riscontrabile su molti veicoli ricreazionali.

### CARATTERISTICHE:

- Tessuto in TNT antigraffio e traspirante a 4 strati resistente ai raggi UV
- Ottima protezione del mezzo da fattori esterni quali pioggia, sole, polvere, inquinamento chimico, escrementi animali, foglie, ecc
- Ottimo sistema di fissaggio antivento mediante robuste cinghie dotate di fibbia tensionatrice
- Dotate di cerniere laterali che permettono un comodo accesso al mezzo quando coperto
- Dotate di cerniere posteriori che facilitano notevolmente le operazioni di copertura e permettono l'accesso alla parte posteriore del mezzo quando coperto
- Complete di sacca custodia
- Colore: grigio chiaro/grigio scuro

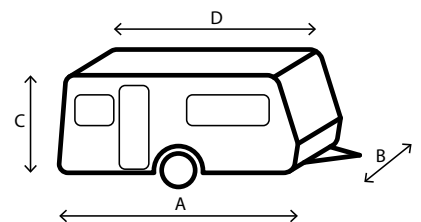





## CLI-MATS NT

Set oscuranti termici composto da tre elementi realizzati in tessuto multistrato.

Art.	Modello	€ tbc	M.O.	Master
Art. 7241319N	Fiat Ducato 1991-06/1994	€ tbc	1	4 24
Art. 7241320N	Fiat Ducato 07/1994-06/2002	€ tbc	1	4 24
Art. 7241321N	Fiat Ducato 244 07/2002-06/2006	€ tbc	1	4 24
Art. 7241314N	Fiat Ducato x250 07/2006-06/2014 <b>Best Seller</b>	€ tbc	1	4 -
Art. 7241304N	Fiat Ducato x290 07/2014--> <b>Best Seller</b>	€ tbc	1	4 24
Art. 7241279N	Fiat Talento 2017-->	€ tbc	1	4 24
Art. 7241322N	Mercedes Benz Sprinter 07/2000-06/2006	€ tbc	1	4 24
Art. 7241313N	Mercedes Benz Sprinter 07/2006-06/2014	€ tbc	1	4 24
Art. 7241315N	Mercedes Benz Sprinter 07/2014-06/2018	€ tbc	1	4 24
Art. 7241278N	Mercedes Benz Sprinter 07/2018-->	€ tbc	1	4 24
Art. 7241323N	Ford Transit 2.6 07/2000-06/2006	€ tbc	1	4 36
Art. 7241312N	Ford Transit 2.7 07/2006-06/2014	€ tbc	1	4 24
Art. 7241306N	Ford Transit 2.8 07/2014-->	€ tbc	1	4 24
Art. 7241316N	Ford Transit Custom 10/2012-11/2017	€ tbc	1	4 24
Art. 7241305N	Ford Transit Custom 12/2017-->	€ tbc	1	4 24
Art. 7241310N	Ford Transit Custom Rain Sensor 12/2017-->	€ tbc	1	4 24
Art. 7241324N	VW T4 1990-05/2003	€ tbc	1	4 24
Art. 7241328N	VW T5 06/2003-06/2014	€ tbc	1	4 -
Art. 7241292N	VW T6 07/2014-->	€ tbc	1	4 24
Art. 7241311N	VW Crafter 07/2006-06/2012	€ tbc	1	4 24
Art. 7241300N	VW Crafter 07/2012-06/2017	€ tbc	1	4 24
Art. 7241325N	Renault Trafic 2S+3S 07/2001-06/2014	€ tbc	1	4 24
Art. 7241293N	Renault Trafic 07/2014-->	€ tbc	1	4 24
Art. 7241326N	Renault Master 2S 1997-06/2003	€ tbc	1	4 24
Art. 7241329N	Renault Master 3S 07/2003-06/2010	€ tbc	1	4 36
Art. 7241379N	Renault Master 4S 07/2010-06/2014	€ tbc	1	4 24
Art. 7241285N	Renault Master 5S 07/2014-->	€ tbc	1	4 24
Art. 7241352N	Iveco Daily 4S 07/2006-06/2014	€ tbc	1	4 24
Art. 7241303N	Iveco Daily 5S 07/2014-->	€ tbc	1	4 24
Art. 7241363N	Citroen Campster 2017-->	€ tbc	1	4 24

## CLI-MATS NT THERMO

IN

OUT

Set oscuranti termici composto da un grande oscurante per il parabrezza e due oscuranti per i finestrini laterali. Sacca custodia inclusa.

Art.	Modello	€ tbc	M.O.	Master
Art. 7241283N	Fiat Ducato x290 07/2014-->	€ tbc	1	1 24
Art. 7241284N	Mercedes Benz Sprinter 07/2014-06/2018	€ tbc	1	1 24
Art. 7241286N	Ford Transit 2.8 07/2014-->	€ tbc	1	1 24
Art. 7241288N	VW T5 06/2003-06/2014	€ tbc	1	1 24
Art. 7241287N	VW T6 07/2014-->	€ tbc	1	1 24



## CLI-MATS NT THERMO BLACK

IN

OUT

Specificamente sviluppato per l'uso invernale, questo set di oscuranti termici in 3 pezzi ha un alto effetto di isolamento termico contro il freddo. Perfettamente adatto anche come protezione della propria privacy. Facile e veloce da montare grazie a ventose dotate di un'eccellente aderenza. Esterno: Nero, in pellicola lavabile. Interno: Grigio, in pellicola lavabile. Con borsa custodia.

Art.	Modello	€ tbc	M.O.	Master
Art. 7241283N.C03	Fiat Ducato x290 07/2014-->	€ tbc	1	1 24
Art. 7241288N.C03	VW T5 06/2003-06/2014	€ tbc	1	1 24
Art. 7241287N.C03	VW T6 07/2014-->	€ tbc	1	1 24



## CLI-MATS NT ROLL

Art. 7241299N

€ tbc  
50 / 50 / -

- Roll 50 m
- PE / PVC

Tessuto isolante a 7 strati per oscuranti Cli-Mats.



## CLI-MATS ROLL

Art. 7241330N

€ tbc  
1 / 1 / 24

- Roll 30 m
- PE / PVC

Tessuto isolante pluristrato per oscuranti Cli-Mats e Cara-Mats.



## CLI-MATS CAPS

Art. 7241327C

€ tbc  
12 / 12 / -

PACK 3X

Kit ventose per oscuranti termici Cli-Mats.



## CLI-MATS MAGNET

			M.O.	Master	
Art. 7241571N	VW T5/T6 2003-->	€ tbc	1	1	-
Art. 7241572N	VW Caravelle	€ tbc	1	1	-
Art. 7241573N	VW Multivan	€ tbc	1	1	-
Art. 7241574N	VW Caddy 2012-20	€ tbc	1	1	-
Art. 7241575N	VW Caddy 2020-->	€ tbc	1	1	-
Art. 7241576N	Peugeot - Toyota - Citroen	€ tbc	1	1	-
Art. 7241577N	Mercedes V-Klasse 2014-->	€ tbc	1	1	-
Art. 7241578N	Fiat Ducato 2014-->	€ tbc	1	1	-

Il nostro nuovo sistema di fissaggio magnetico consente di fissare saldamente gli oscuranti termici Cli-Mats Magnet al telaio del parabrezza del veicolo in pochi secondi. Grazie allo speciale tessuto termico a 7 strati, i Cli-Mats Magnet isolano efficacemente l'abitacolo del veicolo dal caldo e dal freddo, proteggono dalla luce diretta del sole e dalla luce e proteggono dagli sguardi indiscreti. Il taglio e la calzata ottimali consentono inoltre di oscurare completamente questa zona del veicolo (blackout).

## TAPALUX

			M.O.	Master	
Art. 7241581N	VW T5/T6 Short Version 2003-->	€ tbc	1	1	-
Art. 7241582N	Peugeot - Toyota - Citroen - Opel	€ tbc	1	1	-
Art. 7241583N	Mercedes Klasse V 2014-->	€ tbc	1	1	-
Art. 7241584N	Mercedes Vito 2014-->	€ tbc	1	1	-

**Le tende oscuranti Tapalux offrono una moltitudine di vantaggi che danno una vera sensazione di benessere casalingo. Tutti i set di tende oscuranti della collezione Tapalux sono composti da 5 elementi e sono realizzati con un tessuto pesante, a doppio strato, lussuoso e oscurante al 100%, perfetto per il vostro veicolo. Colore del tessuto: grigio/nero.**

### LE TENDE OSCURANTI OFFRONO NUMEROSI VANTAGGI:

- Il doppio strato di tessuto blocca al 100% l'ingresso della luce
- L'abitacolo rimane più fresco perché le tende impediscono ai raggi solari di penetrare all'interno del veicolo
- Protezione dagli sguardi indiscreti all'interno del veicolo

### CARATTERISTICHE:

- Set composto da 5 pezzi per i 4 finestrini laterali e il portellone posteriore
- Lavabili in lavatrice
- Non necessitano di stiratura
- Look professionale

### IL SET COMPLETO DI CINQUE PEZZI OSCURANTI COMPRENDE:

- Binari per tenda di colore grigio
- Tessuto per tende a doppio strato
- Materiale di montaggio





## CLI-MATS XT



Oscuranti termici esterni per cabine guida.

Art.	Modello	Prezzo	M.O.	Master	Icona
Art. 7241331N	Fiat Ducato 1991-06/1994	€ tbc	1	4	24
Art. 7241332N	Fiat Ducato 07/1994-06/2002	€ tbc	1	4	24
Art. 7241333N	Fiat Ducato 244 07/2002-06/2006	€ tbc	1	4	24
Art. 7241351N	Fiat Ducato x250 07/2006-06/2014 <b>Best Seller</b>	€ tbc	1	4	40
Art. 7241307N	Fiat Ducato x290 07/2014-->	€ tbc	1	4	24
Art. 7241367N	Fiat Talento 2017-->	€ tbc	1	4	24
Art. 7241334N	Mercedes Benz Sprinter 07/2000-06/2006	€ tbc	1	4	24
Art. 7241354N	Mercedes Benz Sprinter 07/2006-06/2014	€ tbc	1	4	24
Art. 7241432N	Mercedes Benz Sprinter 07/2014-06/2018	€ tbc	1	4	24
Art. 7241437N	Mercedes Benz Sprinter 07/2018-->	€ tbc	1	4	24
Art. 7241335N	Ford Transit 2.6 07/2000-06/2006	€ tbc	1	4	24
Art. 7241355N	Ford Transit 2.7 07/2006-06/2014	€ tbc	1	4	24
Art. 7241309N	Ford Transit 2.8 07/2014-->	€ tbc	1	4	24
Art. 7241318N	Ford Transit Custom 10/2012-11/2017	€ tbc	1	4	24
Art. 7241276N	Ford Transit Custom 12/2017-->	€ tbc	1	4	24
Art. 7241277N	Ford Transit Custom Rain Sensor 12/2017-->	€ tbc	1	4	24
Art. 7241336N	VW T4 1990-05/2003	€ tbc	1	4	24
Art. 7241346N	VW T5 06/2003-06/2014	€ tbc	1	4	24
Art. 7241365N	VW T6 07/2014-->	€ tbc	1	4	24
Art. 7241356N	VW Crafter 07/2006-06/2012	€ tbc	1	4	24
Art. 7241358N	VW Crafter 07/2012-06/2017	€ tbc	1	4	24
Art. 7241338N	Renault Trafic 2S+3S 07/2001-06/2014	€ tbc	1	4	24
Art. 7241272N	Renault Trafic 07/2014-->	€ tbc	1	4	24
Art. 7241337N	Renault Master 2S 1997-06/2003	€ tbc	1	4	24
Art. 7241347N	Renault Master 3S 07/2003-06/2010	€ tbc	1	4	24
Art. 7241364N	Renault Master 4S 07/2010-06/2014	€ tbc	1	4	24
Art. 7241274N	Renault Master 5S 07/2014-->	€ tbc	1	4	24
Art. 7241353N	Iveco Daily 4S 07/2006-06/2014	€ tbc	1	1	24
Art. 7241273N	Iveco Daily 5S 07/2014-->	€ tbc	1	4	24
Art. 7241384N	Citroen Campster 2017-->	€ tbc	1	4	24

## CARA MATS XT



Oscuranti termici esterni per finestre di caravan.

Art.	Dimensione	Prezzo	M.O.	Master	Icona
Art. 7241339N	110 x 75 cm	€ tbc	1	4	-
Art. 7241340N	130 x 75 cm	€ tbc	1	4	-
Art. 7241341N	140 x 75 cm	€ tbc	1	4	-
Art. 7241342N	160 x 75 cm	€ tbc	1	4	-
Art. 7241343N	170 x 75 cm	€ tbc	1	4	-
Art. 7241344N	180 x 80 cm	€ tbc	1	4	-
Art. 7241345N	190 x 80 cm	€ tbc	1	4	-



## HEKI COVER PRO

Coperture di protezione concepite appositamente per tutti gli oblò della linea Heki. Costruite con materiale multistrato isolante, resistente alle intemperie ed alla grandine.

Art.	Modello	Prezzo	M.O.	Master	Icona
Art. 7145211N	Heki I	€ tbc	1	1	48
Art. 7145212N	Heki II	€ tbc	1	1	48
Art. 7145213N	Heki III e IV	€ tbc	1	1	48
Art. 7145214N	Mini Heki	€ tbc	1	1	48
Art. 7145215N	Midi Heki	€ tbc	1	1	48
Art. 7145216N	Heki Universal	€ tbc	1	1	48





# CLI-MATS SPLIT

## CLI-MATS SPLIT

Copertura integrale isolante per cabine guida di veicoli ricreazionali. Parabrezza e vano motore possono essere coperti, a seconda della stagione, contemporaneamente o separatamente. Ottima isolazione grazie allo speciale materiale multistrato. Con balza perimetrale.



Art.	Modello	Prezzo	M.O.	Master	Icona
Art. 7241405N	Fiat Ducato 1991-06/1994	€ tbc	1	1	24
Art. 7241390N	Fiat Ducato 07/1994-06/2002 <b>Best Seller</b>	€ tbc	1	1	24
Art. 7241391N	Fiat Ducato 244 07/2002-06/2006 <b>Best Seller</b>	€ tbc	1	1	24
Art. 7241392N	Fiat Ducato x250 07/2006-06/2014 <b>Best Seller</b>	€ tbc	1	1	15
Art. 7241387N	Fiat Ducato x290 07/2014--> <b>Best Seller</b>	€ tbc	1	1	15
Art. 7241269N	Fiat Talento 2017-->	€ tbc	1	1	24
Art. 7241393N	Mercedes Benz Sprinter 07/2000-06/2006	€ tbc	1	1	24
Art. 7241394N	Mercedes Benz Sprinter 07/2006-06/2014	€ tbc	1	1	24
Art. 7241408N	Mercedes Benz Sprinter 07/2014-06/2018	€ tbc	1	1	24
Art. 7241268N	Mercedes Benz Sprinter 07/2018-->	€ tbc	1	1	24
Art. 7241404N	Ford Transit 2.6 07/2000-06/2006	€ tbc	1	1	24
Art. 7241395N	Ford Transit 2.7 07/2006-06/2014 <b>Best Seller</b>	€ tbc	1	1	24
Art. 7241386N	Ford Transit 2.8 07/2014--> <b>Best Seller</b>	€ tbc	1	1	24
Art. 7241399N	Ford Transit Custom 10/2012-11/2017	€ tbc	1	1	24
Art. 7241267N	Ford Transit Custom 12/2017-->	€ tbc	1	1	24

Art.	Modello	Prezzo	M.O.	Master	Icona
Art. 7241266N	Ford Transit Custom Rain Sensor 12/2017-->	€ tbc	1	1	24
Art. 7241407N	VW T4 1990-05/2003	€ tbc	1	1	24
Art. 7241396N	VW T5 06/2003-06/2014	€ tbc	1	1	24
Art. 7241265N	VW T6 07/2014-->	€ tbc	1	1	24
Art. 7241264N	VW Crafter 07/2006-06/2012	€ tbc	1	1	24
Art. 7241260N	VW Crafter 07/2012-06/2017	€ tbc	1	1	24
Art. 7241410N	Renault Trafic 2S+3S 07/2001-06/2014	€ tbc	1	1	24
Art. 7241388N	Renault Trafic 07/2014-->	€ tbc	1	1	24
Art. 7241402N	Renault Master 2S 1997-06/2003	€ tbc	1	1	24
Art. 7241389N	Renault Master 3S 07/2003-06/2010	€ tbc	1	1	24
Art. 7241398N	Renault Master 4S 07/2010-06/2014	€ tbc	1	1	24
Art. 7241406N	Renault Master 5S 07/2014-->	€ tbc	1	1	24
Art. 7241401N	Iveco Daily 4S 07/2006-06/2014	€ tbc	1	1	24
Art. 7241385N	Iveco Daily 5S 07/2014-->	€ tbc	1	1	24
Art. 7241400N	Citroen Campster 2017-->	€ tbc	1	1	24







## A-COVER

Art. 7130209N

€ tbc  
10 / 20 / -

100% PVC

Copritimone in foglio di PVC, con bordatura di rinforzo.



## THERMOSTEER

Art. 7130213N

€ tbc  
6 / 24 / -

Ø 48,5 cm

145 g

100% PE / PVC

Copertura per volante realizzata in materiale termoriflettente. Ideale per non scottarsi le mani e proteggere il volante da temperature troppo elevate. Montaggio rapidissimo. Adatto a tutte le misure di volante standard.



## GASTANK COVER

Art. 7130214N

€ tbc  
8 / 8 / -



Protezione multistrato in materiale termoriflettente per bombole gas 11 kg.







## WHEEL COVER

Protezioni copriruote per caravan e camper.



			M.O.	Master	
Art. 7130205N	For caravan tyres (13" - 15")	€ tbc	6	12	-
Art. 7130208N	For motorhome tyres (16" - 18")	€ tbc	6	12	-



## APRON 50

Art. 7130215N

€ tbc  
1/1/-

Roll 50 m x H50 cm

100% PVC

## APRON 70

Art. 7130216N

€ tbc  
1/1/-

Roll 50 m x H70 cm

100% PVC

## APRON STORAGE

Art. 7130217N

€ tbc  
1/6/66

600 x 40 + 14 cm

Polyester Oxford PVC



Grembiule paravento per verande caravan. Realizzato in resistentissimo tessuto spalmato PVC su entrambi i lati.

**ATTENZIONE: LA VENDITA DI QUESTO PRODOTTO NON E' CONSENTITA IN GERMANIA**

Pratica protezione antivento dotata di grandi scomparti con cerniera. Unica lunghezza, adattabile alla misura desiderata.





## CLIMATS ALLROUND VW



Set oscuranti termici Allround per VW.

Art.	Modello	Prezzo	M.O.	Master	Icona
Art. 7241434N	VW T4 2002-04	€ tbc	1	1	24
Art. 7241422N	VW T5 OE 2004-10	€ tbc	1	1	24
Art. 7241423N	VW T5 WOE Short Version 2004-->	€ tbc	1	1	24
Art. 7241421N	VW T6	€ tbc	1	1	24
Art. 7241433N	Multivan Starline 2004-->	€ tbc	1	1	24
Art. 7241430N	Transporter 2004-->	€ tbc	1	1	24
Art. 7241429N	California 2010-->	€ tbc	1	1	24
Art. 7241435N	California Beach	€ tbc	1	1	24

## CLI-MATS NT VW

Set oscuranti termici composto da tre elementi realizzati in tessuto multistrato ad alta isolamento termica.

Art.	Modello	Prezzo	M.O.	Master	Icona
Art. 7241324N	VW T4 1990-05/2003	€ tbc	1	4	24
Art. 7241328N	VW T5 06/2003-06/2014	€ tbc	1	4	-
Art. 7241292N	VW T6 07/2014-->	€ tbc	1	4	24

# VOLKSWAGEN COLLECTION

T4 - T5 - T6



## THERMOSKIN XT

Telo isolante Thermoskin per tetti rialzabili.

### CARATTERISTICHE:

- Resistente all'acqua e ai raggi UV
- Impedisce perdita di calore in inverno e protegge dai calori estivi
- Protegge da umidità
- E' inclusa una sacca custodia



			M.O.	Master
Art. 7130197N	VW T4	€ tbc	1	1 24
Art. 7130199N	VW T5	€ tbc	1	1 24
Art. 7130188N	VW T6	€ tbc	1	1 24



## THERMOSKIN NT

Telo isolante Thermoskin per tetti rialzabili di T4, T5 e T6. Protegge da acqua di condensa e spiacevole umidità. In dotazione anche una comoda sacca.

			M.O.	Master
Art. 7130195N	VW T4	€ tbc	1	1 24
Art. 7130196N	VW T5	€ tbc	1	1 24
Art. 7130187N	VW T6	€ tbc	1	1 24



# VOLKSWAGEN

## T4 - T5 - T6

### COLLECTION



## TAPIS DELUXE

Tappetino per cabina guida.



Art.	Modello	€ tbc	M.O.	Master	
Art. 0201207N	VW T4 1990-05/2003	€ tbc	1	6	-
Art. 0201208N	VW T5 06/2003-06/2014	€ tbc	1	6	-
Art. 0201226N	VW T6 07/2014-->	€ tbc	1	6	-

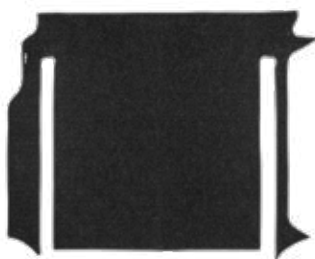

## TAPIS CA

Tappeto zona passeggeri per Volkswagen T5 California Comfortline/Trendline.



Art.	Modello	€ tbc	M.O.	Master	
Art. 0201230N	California Comfortline/Trendline 4P (2 alurails)	€ tbc	1	1	-
Art. 0201231N	California Comfortline/Trendline 5P (alurails)	€ tbc	1	1	-
Art. 0201232N	California Beach 2011 (4 rails)	€ tbc	1	1	-



## TAPIS BA

Resistente tappeto per bagagliaio per VW T5 e T6.



Art.	Modello	€ tbc	M.O.	Master	
Art. 0201233N	VW T5 Short Version	€ tbc	1	1	-
Art. 0201234N	VW T5 Long Version	€ tbc	1	1	-
Art. 0201235N	VW T6 Short Version	€ tbc	1	1	-
Art. 0201236N	VW T6 Long Version	€ tbc	1	1	-



## STEPPER MICRO

Tappetino di accesso per camper. Fissaggio tramite dispositivo a strappo compreso nella confezione.



Art.	Modello	€ tbc	M.O.	Master	
Art. 0201187N	VW T5	€ tbc	1	10	-
Art. 0201191N	VW T6	€ tbc	1	10	-



# CAMPSTER & CROSSCAMP

## COLLECTION



### CLI-MATS NT

Set oscuranti termici composto da tre elementi realizzati in tessuto multistrato.

Art. 7241363N	Citroen Campster 2017-->	€ tbc	M.O.	Master	
			1	4	24



### TAPIS DELUXE

Tappetino per cabina guida.

Art. 0201199N	Citroen Campster 2017-->	€ tbc	M.O.	Master	
			1	6	-



### CLIMATS ALLROUND

Set oscuranti termici Allround.

Art. 7241454N	Citroen Campster	€ tbc	M.O.	Master	
			1	1	24
Art. 7241455N	Citroen Spacetourer	€ tbc	1	1	24
Art. 7241438N	Toyota Crosscamp	€ tbc	1	1	24

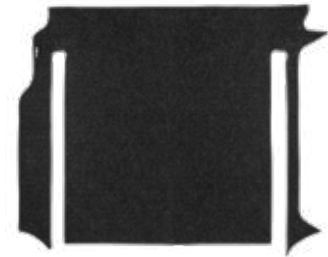

### TAPIS CA

Tappeto zona passeggeri per Citroen Campster.

Art. 0201197N	Citroen Campster 2017	€ tbc	M.O.	Master	
			1	6	-



### THERMOSKIN XT

Telo isolante Thermoskin per tetti rialzabili.



#### CARATTERISTICHE:

- Resistente all'acqua e ai raggi UV
- Impedisce perdita di calore in inverno e protegge dai calori estivi
- Protegge da umidità
- E' inclusa una sacca custodia

Art. 7130186N	Citroen Campster	€ tbc	M.O.	Master	
			1	1	24
Art. 7130185N	Toyota Crosscamp	€ tbc	1	1	24



### TAPIS BA

Resistente tappeto per bagagliaio per Citroen Campster.

Art. 0201196N	Citroen Campster 2017	€ tbc	M.O.	Master	
			1	6	-



## TAPIS DELUXE

Tappetino per cabina guida.



Art.	Modello	Prezzo	M.O.	Master	Icona
Art. 0201200N	Fiat Ducato 1991-06/1994	€ tbc	1	6	-
Art. 0201201N	Fiat Ducato 07/1994-06/2002	€ tbc	1	6	-
Art. 0201202N	Fiat Ducato 244 07/2002-06/2006	€ tbc	1	6	-
Art. 0201215N	Fiat Ducato x250 07/2006-06/2014	€ tbc	1	6	-
Art. 0201205N	Fiat Ducato x290 07/2014-->	€ tbc	1	6	-
Art. 0201192N	Fiat Ducato 2019-->	€ tbc	1	12	-
Art. 0201216N	Mercedes Benz Sprinter 07/2000-06/2006	€ tbc	1	6	-
Art. 0201204N	Mercedes Benz Sprinter 07/2006-06/2014	€ tbc	1	6	-
Art. 0201195N	Mercedes Benz Sprinter 07/2014-06/2018	€ tbc	1	6	-
Art. 0201193N	Mercedes Benz Sprinter 07/2018-->	€ tbc	1	6	-
Art. 0201218N	Ford Transit 2.6 07/2000-06/2006	€ tbc	1	6	-
Art. 0201219N	Ford Transit 2.7 07/2006-06/2014	€ tbc	1	6	-
Art. 0201206N	Ford Transit 2.8 07/2014 --> / Ford Transit Custom 10/2012 --> / Ford Transit Custom Rain Sensor 12/2017 -->	€ tbc	1	6	-
Art. 0201207N	VW T4 1990-05/2003	€ tbc	1	6	-
Art. 0201208N	VW T5 06/2003-06/2014	€ tbc	1	6	-
Art. 0201226N	VW T6 07/2014-->	€ tbc	1	6	-
Art. 0201209N	VW Crafter 07/2006-06/2012	€ tbc	1	6	-
Art. 0201227N	VW Crafter 07/2012-06/2017	€ tbc	1	6	-
Art. 0201211N	Renault Trafic 25+35 07/2001-06/2014	€ tbc	1	6	-
Art. 0201189N	Renault Trafic 07/2014-->	€ tbc	1	6	-
Art. 0201212N	Renault Master 25 1997-06/2003	€ tbc	1	6	-
Art. 0201213N	Renault Master 35 07/2003-06/2010	€ tbc	1	6	-
Art. 0201222N	Renault Master 45 07/2010-06/2014	€ tbc	1	6	-
Art. 0201194N	Renault Master 55 07/2014-->	€ tbc	1	6	-
Art. 0201220N	Iveco Daily 4S 07/2006-06/2014	€ tbc	1	6	-
Art. 0201224N	Iveco Daily 5S 07/2014-->	€ tbc	1	6	-
Art. 0201199N	Citroen Campster 2017-->	€ tbc	1	6	-



# TAPIS DELUXE

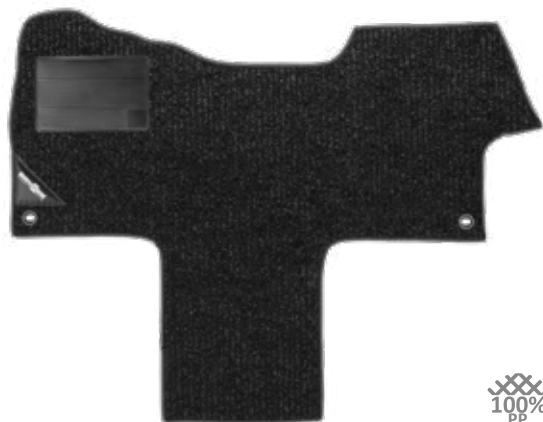

## TAPIS DELUXE SECURITY

Tappeto per cabina guida con sistema di bloccaggio.

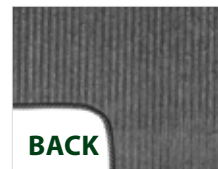
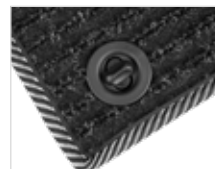
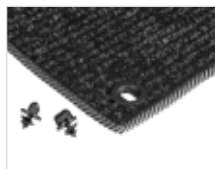

Art.	Modello	Prezzo	M.O.	Master	Icona
Art. 0201240N	Ducato 2006-14	€ tbc	1	6	-
Art. 0201239N.C03	Ducato 2015-->	€ tbc	1	6	-
Art. 0201229N.C03	Ducato 2019-->	€ tbc	1	12	-



## TAPIS RUBBERMAT

Bellissimi tappetini per cabina guida a sagoma perfetta realizzati interamente in gomma inodore di prima qualità. Ideali per proteggere il veicolo da sporco ed umidità. Ottima aderenza al pavimento del veicolo che evita fastidiosi scivolamenti sotto ai pedali. Facili da posizionare/rimuovere e da pulire. Disponibili per tutti i modelli di veicoli più diffusi.

Art.	Modello	€ tbc	M.O.	Master	
Art. 0201009N	Ducato/Citroen	€ tbc	1	1	-
Art. 0201010N	Transit Custom Automatic	€ tbc	1	1	-
Art. 0201011N	Transit Custom Manual	€ tbc	1	1	-
Art. 0201013N	VW T6.1 Transporter/Multivan 01/2020-->	€ tbc	1	1	-
Art. 0201014N	Transport VW T5 2004--> / VW T6 2015-12/2019	€ tbc	1	1	-



## RUNNER

Corsia per veicoli ricreazionali, con fondo antisdrucciolo.



Art.	Dimensioni	€ tbc	M.O.	Master	
Art. 0201003N.C06	45 x 45 cm	€ tbc	1	6	-
Art. 0201001N.C06	80 x 45 cm	€ tbc	1	6	-
Art. 0201004N.C06	150 x 45 cm	€ tbc	1	6	-
Art. 0201002N.C06	200 x 45 cm	€ tbc	1	6	-
Art. 0201006N.C06	250 x 45 cm	€ tbc	1	6	-
Art. 0201007N.C06	300 x 45 cm	€ tbc	1	4	-
Art. 0201008N.C06	350 x 45 cm	€ tbc	1	3	-

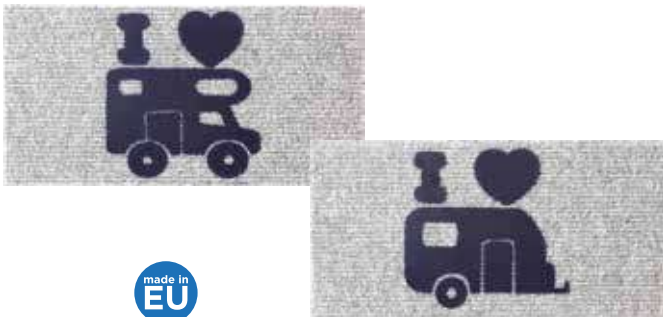

## HELLO CAMPER

Art. 0201034N.CA

€ tbc  
5 / 15 / -

25 x 50 cm

100% PP

## HELLO CARAVAN

Art. 0201034N.CV

€ tbc  
5 / 15 / -

25 x 50 cm

100% PP

Pratico zerbino con simpatici motivi legati al camper e alla caravan. Protegge gli interni del mezzo da terra, polvere e sporco. Dotato di rivestimento inferiore antisdrucciolo.



## STEPPER MICRO

Tappetino di accesso per camper. Fissaggio tramite dispositivo a strappo compreso nella confezione.

Art.	Modello	€ tbc	M.O.	Master	
Art. 0201180N	Ducato 2002-06	€ tbc	1	10	-
Art. 0201166N	Ducato 2006-14	€ tbc	1	10	60
Art. 0201188N	Ducato 2015-08/2019	€ tbc	1	10	-
Art. 0201182N	Mercedes Sprinter 2006-->	€ tbc	1	10	-
Art. 0201181N	Ford Transit 2006-->	€ tbc	1	10	-
Art. 0201170N	Ducato 09/2019-->	€ tbc	1	10	-





# BIKE COVER

## COLLECTION



### BIKE COVER 2/3 - BIKE COVER 4



Art.	Model	€ tbc	M.O.	Master	
Art. 7130219N	BIKE COVER 2/3	€ tbc	4	4	84
Art. 7130210N	BIKE COVER 4	€ tbc	4	4	72
Art. 7130200N	BIKE COVER SPECIAL 2/3	€ tbc	4	4	84
Art. 7130220N	E-BIKE COVER 2	€ tbc	4	4	84
Art. 7130212N	BIKE COVER CVN 2	€ tbc	4	4	72



Warning sign not included

Copribicicletta in resistente tessuto di poliestere con spalmatura idrorepellente. Dotato di speciale tasca per la sistemazione del cartello carichi sporgenti.



Reflector

### BIKE COVER SPECIAL 2/3



### E-BIKE COVER 2



# BIKE COVER TOW BAR COLLECTION

NEW  
2023

Art.	Descrizione	€ tbc	M.O.	Master	
Art. 7130201N	BIKE COVER TB 2	€ tbc	4	4	-
Art. 7130203N	BIKE COVER TB 4	€ tbc	4	4	-



Copribici di alta qualità per portabiciclette montati su gancio di traino. Realizzato in robusto tessuto di poliestere spalmato e impermeabile. La sicurezza è ulteriormente garantita da diverse cinghie di tensione che impediscono l'eccessivo sventolio del telo in caso di forte vento. Con tasca trasparente per cartello carichi sporgenti. Inclusa borsa custodia. Disponibile in 2 versioni, per 2 e 4 biciclette.



## ZEBRA PL

Art. 7136010N

€ tbc  
10 / 10 / -

50 x 50 cm

Cartello carichi sporgenti in materiale plastico con 4 retroriflettori. Non omologato in Italia!



## ZEBRA ALU

Art. 7136012N

€ tbc  
5 / 10 / -

50 x 50 cm

Cartello per carichi sporgenti in alluminio. Obbligatorio in Italia!

## BIKE COVER CVN 2

NEW  
2023

## BIKE HOOD NG

Art. 7130211N

€ tbc  
4 / 4 / -

Telo protettivo per biciclette adatto anche per piccoli motorini.

220 x 65 x H140 cm

Polyester PU





# BAG COLLECTION



## LEVELER BAG

Art. 7241005N

57 x 20 x 15 cm

100% Oxford Polyester

Borsa per 2 cunei livellatori.



## PRO-BAG CABLE S

Art. 7241009N

Ø 36 x 10 cm

100% Oxford Polyester

Borsa custodia e di protezione per cavi prolunga.



€ tbc  
10 / 10 / -

€ tbc  
10 / 10 / -



## PRO-BAG MIRROR

Art. 7241016N

40 x 20 x 12 cm

100% Oxford Polyester

Borsa custodia e di protezione per specchi retrovisori supplementari.

€ tbc  
10 / 10 / -



## PRO-BAG POLES

Art. 7241015N

120 x 30 x 25cm

100% Oxford Polyester

Borsa custodia e di protezione per paleria tende.

€ tbc  
10 / 10 / -







## PRO-BAG CHAIR

Art. 7241012N

€ tbc  
10 / 10 / -

 120 x 65 x 24 cm

 100% Oxford Polyester

Borsa custodia e di protezione per sedie pieghevoli.

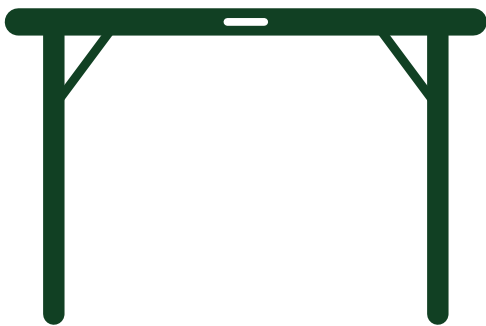



## PRO-BAG TABLE



M.O.

Master



	PRO-BAG TABLE XS	Art. 7241006N	85 x 65 x 6 cm	100% Oxford Polyester	€ tbc	10	10	-
	PRO-BAG TABLE S	Art. 7241010N	100 x 64 x 4 cm	100% Oxford Polyester	€ tbc	10	10	-
	PRO-BAG TABLE M	Art. 7241007N	105 x 75 x 6 cm	100% Oxford Polyester	€ tbc	10	10	-
	PRO-BAG TABLE L	Art. 7241011N	120 x 72 x 6 cm	100% Oxford Polyester	€ tbc	10	10	-
	PRO-BAG TABLE XL	Art. 7241008N	125 x 80 x 7 cm	100% Oxford Polyester	€ tbc	10	10	-

Borsa di protezione e trasporto per tavoli camping ed outdoor realizzata in resistente poliestere.



# KING STEP



## KING STEP

Art. 7225135N

€ tbc  
10 / 10 / 60

43 x 30 x H26/31 cm

2,25 kg

150 kg



COLORS



Gradino di entrata con stabile struttura in acciaio e superficie in gomma antiscivolo.



## KING DOUBLE STEP

Art. 7225136N

€ tbc  
6 / 6 / 18

43 x 63 x H18/38/43 cm

4,1 kg

150 kg



COLORS



Gradino di entrata doppio con stabile struttura in acciaio e superficie in gomma antiscivolo.



## KING DOUBLE STEP XL

Art. 7225137N

€ tbc  
4 / 4 / 16

55 x 62,5 x H18/38 cm

4,5 kg

150 kg



Elegante gradino doppio con ampia superficie antiscivolo. Sovrapponibile.



## STEPPER FIX

Art. 0201165N.C34

€ tbc  
10 / 30 / -

Tappeto coprigradino antiscivolo. Fissaggio semplice e rapido con cinghie nastro a contatto aperti e chiusi.



## STEPPER MOVE

Art. 0201162N

€ tbc  
10 / 30 / -

Tappeto coprigradino antiscivolo. Fissaggio mediante l'aggancio di 2 molle nei fori occhiellati. Adatto per gradini con larghezza 40 cm e profondità regolabile da 20 a 25 cm.

COLORS







## KINTA

Art. 7225153N

€ tbc  
4 / 4 / -

63 x 27,5 x H22 cm

50 x 26 x H4,5 cm

2,5 kg

150 kg

Gradino singolo facilmente trasportabile dotato di gambe pieghevoli. La superficie del gradino è realizzata in plastica antiscivolo per offrire la massima sicurezza possibile in entrata e in uscita dal veicolo. Dimensioni molto compatte quando ripiegato.



## RUCKSTEP

Art. 7225147N

€ tbc  
4 / 4 / 32

61 x 60 x H20/40 cm

81 x 61 x 6,5 cm

6,4 kg

150 kg



Gradino doppio compatto e chiudibile con telaio in metallo e coprigradino anti-slip.



## RUCKSTEP ALU

Art. 7225149N

€ tbc  
4 / 4 / 32

51,5 x 53 x H19,5/38,5 cm

51,5 x 9 x H75,5 cm

4 kg

150 kg

Gradino doppio per caravan e camper. Struttura pieghevole in alluminio, leggera e robusta. Con superficie antiscivolo. Facile da trasportare e riporre.



## GO STEP NG

Art. 7225127N

€ tbc  
1 / 6 / 72

48 x 30 x H23 cm

48 x 30 x H7 cm

2,65 kg

150 kg

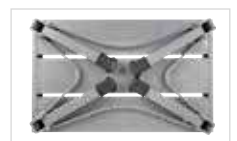

Gradino molto stabile con gambe pieghevoli. Robusta costruzione in alluminio verniciato a polveri.



## PRIMA

Art. 7225134N

€ tbc  
4 / 4 / 24

55 x 61 x H18/37,5/43 cm

67 x 7 x 51 cm

5,5 kg

150 kg



Gradino doppio smontabile realizzato in solido metallo zincato.



# BOXSTEP NG

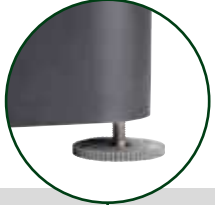
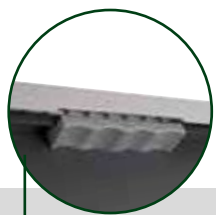

## BOXSTEP NG

Art. 7225160N

€ tbc  
1/1/-

Gradino per veicoli ricreazionali di nuova concezione con spazio interno impermeabile per accessori utili, come attrezzi, liquidi sanitari, prolunghe, ecc. Il coperchio chiudibile mediante gancio a leva è dotato di un profilo antiscivolo ed è dotato anche di una luce solare di sicurezza integrata. Costruzione in plastica di alta qualità, molto stabile, con piedini rotanti per la regolazione del livellamento.

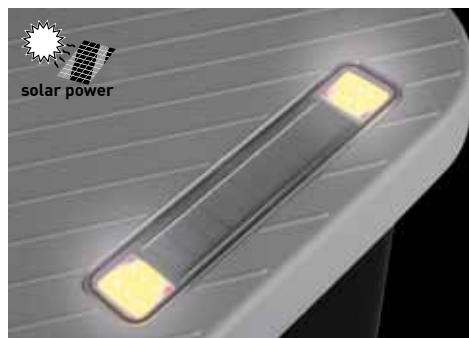





## PLYER

Art. 7225138N.C06

€ tbc  
6 / 12 / -

- 40 x 28 x H23,1 cm
- 40 x 38,2 x 5,5 cm
- 1,3 kg
- 120 kg

Pratico gradino pieghevole per Outdoor e uso casalingo in materiale plastico. Superficie antiscivolo e piedi in gomma.

## RIALTO

Art. 7225140N

€ tbc  
6 / 6 / 60

- 45 x 30 x H23 cm
- 2,3 kg
- 150 kg

Gradino pieghevole compatto per caravan, campeggio e casa. Costruzione in plastica robusta e resistente. Con rivestimento antiscivolo. Facile da piegare e riporre.

## WINK

Art. 7225148N

€ tbc  
6 / 6 / 60

- 44,5 x 26,5 x H25,2 cm
- 55 x 27,5 x 8,3 cm
- 1,45 kg
- 120 kg

Gradino pieghevole in plastica con ampia superficie calpestabile e pratiche maniglie per il trasporto. Pronto all'uso in pochi secondi. Costruzione robusta e affidabile. Molto compatto e facile da riporre quando ripiegato.



## PODIUM L

Art. 7225146N

€ tbc  
12 / 12 / 96

- 50 x 34 x H23 cm
- 1,3 kg
- 150 kg

Gradino in polietilene ad alta densità per veicoli ricreazionali. Esecuzione solida e stabile. Superficie calpestabile antiscivolo. Impilabile.

## GAMUT

Art. 7225129N

€ tbc  
10 / 10 / -

- 49,5 x 34,5 x 23,5 cm
- 1 kg
- 120 kg

Classico gradino per caravan. Completamente realizzato in resistente materiale plastico.

## HOPPER ANTISLIP

Art. 7225142N.C06

€ tbc  
10 / 10 / 80

- 40,5 x 25 x H24,5 cm
- 1,45 kg
- 150 kg

Gradino in plastica per veicoli ricreazionali, con tappetino antiscivolo.



# OUTBOX

**Box in alluminio extra robusti e di alta qualità con uno spessore delle pareti di 1,0 mm. Ideali per lo stivaggio ed il trasporto in sicurezza di attrezzatura importante e di valore grazie alla loro costruzione a tenuta stagna.**

## CARATTERISTICHE:

- Realizzati in lamiera di alluminio di alta qualità
- Spessore delle pareti di 1,0 mm
- Impermeabile, resistente alle intemperie e alle temperature
- Con bordo di rinforzo su tutto il perimetro
- Robusto coperchio di chiusura
- Con 2 maniglie laterali a molla auto ripiegabili
- 2 chiusure a leva solide e facili da usare
- Guarnizione in gomma su tutto il perimetro del coperchio



## OUTBOX ALU 47

Art. 7440011N

€ tbc  
1/1/16

58,2 x 38,5 x 26,2 cm

4,4 kg

47 l

## OUTBOX ALU 73

Art. 7440012N

€ tbc  
1/1/16

58,2 x 38,5 x 39,7 cm

5,2 kg

73 l

## OUTBOX ALU 92

Art. 7440013N

€ tbc  
1/1/9

78,2 x 38,5 x 36,7 cm

6,1 kg

92 l



## NETRAY HD SMALL

Art. 0420015N

€ tbc  
6/6/-

32,5 x 18 x 8 cm

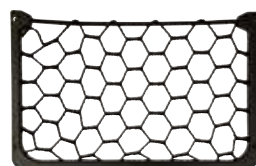

## NETRAY

Art. 0420012N

€ tbc  
10/100/-

31,5 x 21 cm

160 g

## NETRAY HD MEDIUM

Art. 0420016N

€ tbc  
6/6/-

39 x 20 x 8 cm

Rete porta oggetti con bordi in metallo e relativa copertura in materiale plastico. Fissaggio tramite viti.

## NETRAY HD LARGE

Art. 0420018N

€ tbc  
6/6/-

44 x 22,5 x 8 cm

Retina portaoggetti elegante e funzionale composta da un robusto telaio in alluminio verniciato e da una rete elastica. Installazione semplice mediante viti. Disponibile in 3 misure.



## FORT KNOX

Art. 7511005N

€ tbc  
4/16/-

20,5 x 15,5 x 8 cm

1,5 kg

Piccolo porta-valori per camper e caravan.





# LADDY



## LADDY AIR

Art. 7225118N

€ tbc  
1 / 1 / 48

- 293 x 47 x 8,4 cm
- 75 x 47 x 8,4 cm
- 7,5 kg
- 150 kg



Scala telescopica in alluminio con nuova tecnologia di chiusura morbida servoassistita che elimina il rischio di lesioni alle dita. Facile da trasportare e regolabile in altezza. Dotata di piedini in gomma antiscivolo per una maggiore sicurezza. Molto compatta quando chiusa.

## LADDY ALCOVE

Art. 7225121N

€ tbc  
1 / 1 / 40

- 210 x 36 x 6 cm
- 67 x 36 x 6 cm
- 4,5 kg
- 150 kg



Scala telescopica in alluminio per mansarde. Permette un facile accesso ai letti. Con 2 ganci di fissaggio. Facile da trasportare e regolabile in altezza. Dotata di piedini in gomma antiscivolo per una maggiore sicurezza. Molto compatta quando chiusa.

## TRANSAT ALU

Art. 7512015N

€ tbc  
1 / 1 / 50

- H122 cm
- 1,25 kg



Treppiede pieghevole ultraleggero per antenna satellitare in alluminio anodizzato, Ø 40 mm.



## GRIPPER

Art. 7110117N

€ tbc  
10 / 10 / -

74 x 22,5 cm

750 g

PACK 2X



Griglia di partenza con scheletro diagonale. Materiale: PP resistente ai raggi UV.

## TRACTOR

Art. 7110118N

€ tbc  
6 / 6 / 24

60 x 18 cm

30 x 18 cm

960 g

PACK 2X



Griglie di partenza pieghevoli in resistente materiale plastico.



**EXTRA STRONG**

## ALU JACK 2.0

Art. 7140001N

€ tbc  
4 / 4 / -

16 x 16 x H29/42 cm

2x 3,2 kg

1,5 t / Jack

Set di martinetti in alluminio con piastra di supporto a L angolata in acciaio zincato e copertura di protezione antiscivolo in plastica morbida. Costruzione molto stabile e impilabile. In set di 2.



OPTIONAL

## ALU JACK PROTECTOR

Art. 7140003N

€ tbc  
12 / 12 / -

PACK 2X

Copertura antiscivolo in plastica morbida per martinetti in alluminio con piastra di supporto angolata. Protegge la superficie di appoggio da graffi. Montaggio semplice.



**EXTRA STRONG**

## POWER JACK

Art. 7140010N

€ tbc  
6 / 6 / -

2x 2,15 kg

2x 1t

PACK 2X

Set martinetti realizzati in materiale di qualità resistente al freddo ed ai raggi UV.



## TRIANGLE

Art. 0115009C  
PACK 1X

€ tbc  
20 / 400 / -

Art. 0115009N  
PACK -

58 x 45 mm

Livella a bolla triangolare con bolle perpendicolari e fori di fissaggio.



## NIVEAU

Art. 0115011C  
PACK 1X

€ tbc  
12 / 72 / -

Art. 0115011N  
PACK -

100 x 35 x 12 mm

Livella a bolla rettangolare con bolle perpendicolari.



## LEVEL

Art. 0115005N

€ tbc  
5 / 20 / -

230 x 40 x 16 mm

Livella con doppia bolla. Struttura in plastica. Magnetico.



**CARAPAD**

Art. 7110102N

€ tbc  
6 / 12 / -

18 x 14,5 cm

PACK 4X



Piastrine di sostegno per roulotte in materiale plastico resistente.

**CARAPAD HD**

Art. 7110106N

€ tbc  
6 / 12 / -

18 x 14,5 cm

2x 2t

PACK 4X



Basi antisprofondamento per caravan con perno di fissaggio in metallo.

**BASEPAD**

Art. 7110116C.C19

€ tbc  
12 / 12 / -

Ø 16 cm

PACK 4X



Basi antisprofondamento in resistente materiale plastico.

**JACKPAD**

Art. 7110112N

€ tbc  
10 / 200 / -

Ø 23 cm

PACK 4X



Basi antisprofondamento extra-grandi per martinetti stabilizzanti. Esecuzione molto robusta con pratica maniglia. Ideale per garantire la messa in sicurezza di caravan, camper e rimorchi.



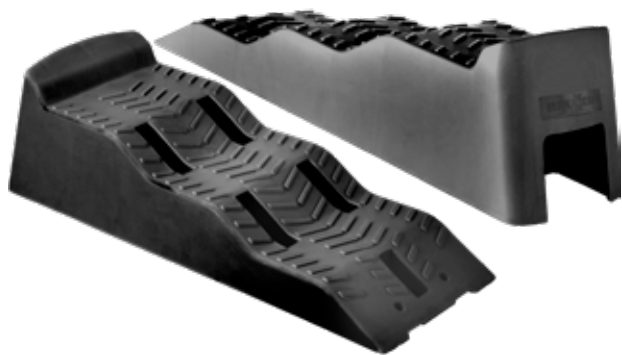

## EQUALIZER XL BLACK

Art. 7110105N.C03

€ tbc  
4 / 4 / 48

UV  
RESISTANT

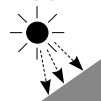

made in  
EU

 56,2 x 20,2 x H15 cm

 3,7 kg

 5t / axle

PACK 2X



Cuneo di livellamento di alta qualità a 3 livelli. Fornito con pratica sacca custodia e da trasporto.





## EQUALIZER XXL

Art. 7110101N

€ tbc  
1 / 1 / 24

NEW  
2023

 85,5 x 26,6 x 22,3 cm

 7,5 kg

 5t / axle

PACK 2X



Grande cuneo di livellamento a 3 livelli ( 6-12-18 cm) realizzato in materiale termoplastico speciale ad alta resistenza. Il design speciale della superficie garantisce un'ottima aderenza dei pneumatici nella fase di salita e livellamento. La base resistente e stabile ne permette l'utilizzo su molteplici terreni, inclusi quelli sabbiosi. Viene fornito in set da 2 pezzi. Completo di pratica borsa per il trasporto.





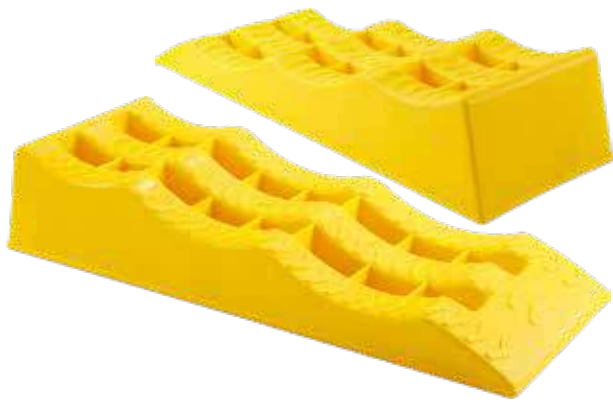



## LEVELER PARKING

Art. 7110107N

€ tbc  
6 / 6 / -
 61 x 21,5 x H12 cm

 2,25 kg

 5t / axle

PACK 2X





Cuneo livellatore a 3 livelli realizzato appositamente per le soste prolungate. Fornito con pratica sacca custodia.

## RAMP SET

Art. 7110111N

€ tbc  
3 / 3 / 39
 64 x 22 x 14 cm

 3,8 kg

 3t / axle

PACK 2X

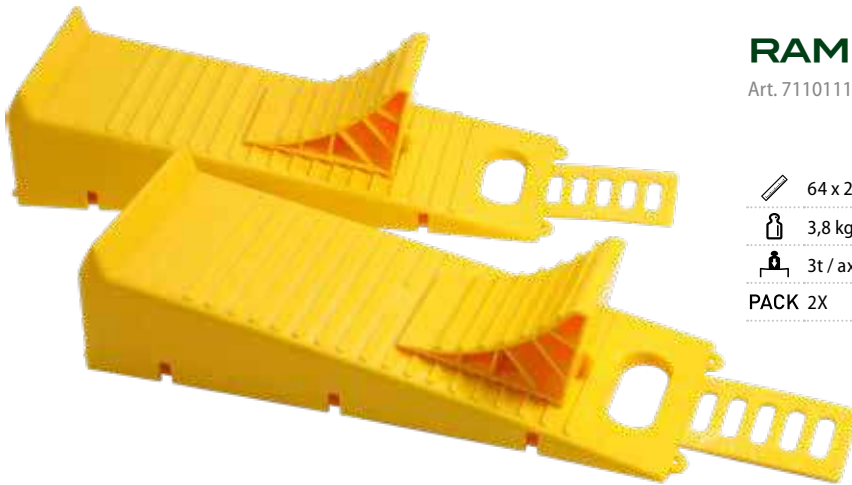



Set di livellamento composto da 2 cunei di livellamento, 2 cunei di arresto per bloccare il mezzo durante periodi di sosta prolungati e 2 piastre antiscivolo per terreni lisci.

## SKEYLA

Art. 0712092N

€ tbc  
10 / 20 / -
 H42,5 cm

 570 g

 50 - 100 kg

Bilancia pesatimone.

Ø 30 mm

Ø 36 mm

Ø 120 mm

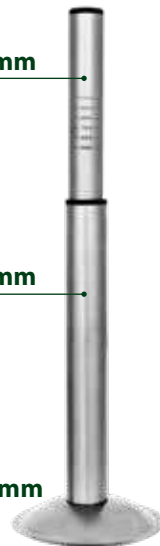

## RUBBY

Fermabauletti in gomma nera inalterabile, completi di supporto ed accessori in metallo.

			M.O.	Master	
Art. 7440008C	65 mm	€ tbc	12	12	-
Art. 7440008N	65 mm	€ tbc	12	12	-
Art. 7440009C	125 mm	€ tbc	12	12	-
Art. 7440009N	125 mm	€ tbc	12	12	-





## SIGMA



PACK

M.O.

Master

Art. 7306368N	Flat Mirror	19 x 12 cm	640 g	1X	€ tbc	6	24	-
Art. 7306369N	Convex Glass	19 x 12 cm	640 g	1X	€ tbc	6	24	-

Specchio retrovisore supplementare universale.



## ECLIPSE

Art. 7306375N

€ tbc  
6 / 24 / -

19 x 12 cm

630 g

PACK 1X

Specchio retrovisore supplementare universale applicabile su specchi originali mediante morsetti a vite. Con asta di estensione laterale in metallo.



## RIDER PRO

Art. 7306345N

€ tbc  
4 / 4 / -

22 x 16 cm

2x 620 g

PACK 2X

Specchietto retrovisore universalmente montabile su quasi tutte le autovetture. Anche indicato per specchi originali di grandi dimensioni. Coppa aerodinamica di grandi dimensioni con speciale specchietto supplementare regolabile che rende visibile l'angolo morto. Fissaggio mediante 2 morsetti di bloccaggio a vite ed una cinghia supplementare di sicurezza regolabile in gomma. Fornito in coppia. Conforme alla normativa E11.



## OROS ANG

Art. 7306328N

€ tbc  
6 / 6 / -

14 x 20 cm

550 g

PACK 1X

Specchio universale Clip-on che si adatta quasi tutti gli specchi originali con vetro regolabile.

# MIRROR COLLECTION





## DELTA ANG

Art. 7306330N



€ tbc  
6 / 6 / -

18,5 x 12,5 cm

420 g

PACK 1X

Specchio retrovisore supplementare da fissare agli specchietti laterali già di serie del mezzo. Utilizzabile sia a destra che a sinistra.



## GAMMA ANG



PACK

M.O.

Master



Art.	Dimensioni	Peso	PACK	Prezzo	M.O.	Master	Altezza
Art. 7306335N.DS	22,5 x 16 cm	560 g	1X	€ tbc	6	6	90
Art. 7306335N.PS	22,5 x 16 cm	560 g	1X	€ tbc	6	6	90

Specchio retrovisore supplementare da fissare agli specchietti laterali del mezzo.



## OPTILUS

Art. 7307103N



COLORS  
 C03

€ tbc  
10 / 90 / -

14,5 x 6 x 4,5 cm

160 g

PACK 1X

Specchio angolo morto per camper e automobili.



## RETRAL

Art. 7307104N

€ tbc  
10 / 70 / -

14,5 x 6 x 4,5 cm

146 g

Speciale specchio retrovisore realizzato per tenere sotto controllo l'abitacolo di camper e vetture.





# DISPLAY BOX



## LUMINA

Art. 0720061N  
8 / 32 / -



## NOCTILUS

Art. 0720060N  
12 / 72 / -



## CITRONELLA CANDLE S

Art. 0205055N  
12 / 48 / -



## CITRONELLA CANDLE M

Art. 0205056N  
12 / 48 / -



## ALFRESCO

Art. 0428054N  
6 / 6 / -



## SPECTRACOOOL 18

Art. 0824038N.C9N  
6 / 6 / 90



## SPECTRACOOOL 25

Art. 0824039N.C9N  
6 / 6 / 60



## FRIOBAG COMPACT

Art. 0824041N  
10 / 10 / -





## HYDROLIN STEEL 1000

Art. 0820026N  
6 / 24 / -



## SHOT

Art. 0820055N  
12 / 24 / -



## LEGEND OUTDOOR 500

Art. 0820050N  
12 / 24 / -



## LEGEND OUTDOOR 1000

Art. 0820051N  
12 / 24 / -



## COOLPAD 400

Art. 0826019N  
12 / 24 / -



## COOLPAD 200

Art. 0826018N  
12 / 24 / -



## GLUG

Art. 0830007N  
6 / 60 / -



## DRINKMASTER S

Art. 0404029N.C9N  
20 / 80 / -



## HUNGRY

Art. 0830110N.C30  
12 / 12 / -



## HUNGRY XL

Art. 0830111N.C30  
12 / 12 / -



## MINI SPOON SET

Art. 0830129N.C9N  
24 / 48 / -



## SPOON SET

Art. 0830128N.C9N  
24 / 96 / -



## MUG'N SPOON

Art. 0830061N.C9N  
12 / 48 / -



## ICE CREAM SCOOPER

Art. 0830038N.C9N  
12 / 48 / -



## SPICE BOX

Art. 0830010N.C9N  
24 / 96 / -



## OLIAC

Art. 0830000N.C9N  
12 / 12 / -



## MELANGE

Art. 0830006N  
12 / 24 / -





## DISPLAY CAMPER SPECTRUM 54Pcs

Art. 0830142N.C9N  
1 / 1 / -

- 6x9 
- art. 0830051N.C19
  - art. 0830051N.C11
  - art. 0830051N.C8A
  - art. 0830051N.C34
  - art. 0830051N.C10
  - art. 0830051N.C30



## DISPLAY CAMPER WINTER 54Pcs

Art. 0830142N.C6N  
1 / 1 / -

- 6x9 
- art. 0830051N.C48
  - art. 0830051N.C1M
  - art. 0830051N.C06
  - art. 0830051N.C1C
  - art. 0830051N.C22
  - art. 0830051N.C9C



## DISPLAY CAMPER AQUARIUS 54Pcs

Art. 0830142N.C1A  
1 / 1 / -

- 6x9 
- art. 0830051N.C08
  - art. 0830051N.C06
  - art. 0830051N.C48
  - art. 0830051N.C30
  - art. 0830051N.C1M
  - art. 0830051N.C22



## DISPLAY CAMPER SUMMER 54Pcs

Art. 0830142N.C4H  
1 / 1 / -

- 6x9 
- art. 0830051N.C34
  - art. 0830051N.C19
  - art. 0830051N.C08
  - art. 0830051N.C06
  - art. 0830051N.C22
  - art. 0830051N.C48



## BBGRILL DINNER PLATE

Art. 0830045N.C5R  
12 / 24 / -



## BBGRILL BOWL

Art. 0830047N.C5R  
12 / 24 / -



## BBGRILL SALAD BOWL

Art. 0830046N.C5R  
6 / 12 / -





## DISPLAY BOX GRANADA 182Pcs

Art. 0830141N.C3S  
1/1/-



24x		art. 0830025N.C3S
24x		art. 0830026N.C3S
24x		art. 0830027N.C3S
24x		art. 0830043N.C3S
12x		art. 0830032N.C3S
24x		art. 0830051N.C1M
8x		art. 0830030N.C3S
9x		art. 0830165N.C71
12x		art. 0832005N.C06
12x		art. 0832015N.C06

## DISPLAY BOX TUSCANY 186Pcs

Art. 0830141N.C5T  
1/1/-



24x		art. 0830027N.C5T
9x		art. 0830165N.C71
8x		art. 0830030N.C5T
24x		art. 0830026N.C5T
24x		art. 0830043N.C5T
24x		art. 0830025N.C5T
12x		art. 0830032N.C5T
6x		art. 0830039N.C06
24x		art. 0830051N.C5T
4x		art. 0830042N.C4S
6x		art. 0832016N.C06
12x		art. 0832005N.C06

## DISPLAY BOX SPECTRUM 200Pcs

Art. 0830141N.C9N  
1/1/-





















24x		art. 0830027N.C1P
24x		art. 0830025N.C1P
12x		art. 0830032N.C1P
8x		art. 0830058N.C1P
8x		art. 0830059N.C1P
9x		art. 0830185N.C1P
9x		art. 0830057N.C1P
6x		art. 0830030N.C1P
4x		art. 0830042N.C9N
		art. 0830039N.C10
2x3		art. 0830039N.C34
		art. 0830039N.C30
2x3		art. 0832016N.C34
		art. 0832016N.C11
		art. 0830055N.C34
3x4		art. 0830055N.C10
		art. 0830055N.C30
		art. 0830055N.C11
		art. 0830022N.C30
2x3		art. 0830022N.C10
		art. 0830022N.C11
		art. 0830026N.C30
6x4		art. 0830026N.C10
		art. 0830026N.C34
		art. 0830026N.C11
		art. 0830043N.C30
6x4		art. 0830043N.C10
		art. 0830043N.C34
		art. 0830043N.C11
		art. 0830051N.C34
3x4		art. 0830051N.C10
		art. 0830051N.C30
		art. 0830051N.C11
		art. 0830040N.C34
2x3		art. 0830040N.C30
		art. 0830040N.C10



## DISPLAY BOX SPACE 210Pcs

Art. 0830141N.C7B

1 / 1 / -

- 24x  art. 0830027N.C7B
- 9x  art. 0830185N.C7B
- 4x  art. 0830030N.C7B
- 9x  art. 0830023N.C7B
- 8x  art. 0830187S.C7B
- 24x  art. 0830026N.C7B
- 12x  art. 0830043N.C7B
- 8x  art. 0830021N.C7B
- 24x  art. 0830025N.C7B
- 3x  art. 0830039N.C34
- 8x  art. 0830058N.C7B
- 9x  art. 0830055N.C34
- 12x  art. 0830032N.C7B
- 12x  art. 0830051N.C34
- 8x  art. 0830059N.C7B
- 6x  art. 0832016N.C34
- 12x  art. 0832005N.C06
- 12x  art. 0832005N.C43
- 6x  art. 0832016N.C06



## DISPLAY BOX BLUE OCEAN 210Pcs

Art. 0830141N.C8C

1 / 1 / -







- 24x  art. 0830027N.C8C
- 9x  art. 0830185N.C8C
- 4x  art. 0830030N.C8C
- 9x  art. 0830022N.C8C
- 8x  art. 0830187S.C8C
- 24x  art. 0830026N.C8C
- 12x  art. 0830043N.C8C
- 8x  art. 0830021N.C8C
- 24x  art. 0830025N.C8C
- 3x  art. 0830039N.C8C
- 8x  art. 0830058N.C8C
- 9x  art. 0830055N.C8C
- 12x  art. 0830032N.C8C
- 12x  art. 0830051N.C22
- 8x  art. 0830059N.C8C
- 6x  art. 0832015N.C30
- 6x  art. 0830040N.C8C
- 12x  art. 0832005N.C06
- 12x  art. 0832005N.C30



## DISPLAY BOX SPACE 225Pcs

Art. 0830130N.C7B

1 / 1 / -







- 48x  art. 0830025N.C7B
- 48x  art. 0830027N.C7B
- 21x  art. 0830185N.C7B
- 48x  art. 0830026N.C7B
- 24x  art. 0830043N.C7B
- 12x  art. 0830030N.C7B
- 24x  art. 0830051N.C34



## DISPLAY BOX BLUE OCEAN 225Pcs

Art. 0830130N.C8C

1 / 1 / -

- 48x  art. 0830025N.C8C
- 48x  art. 0830027N.C8C
- 21x  art. 0830185N.C8C
- 48x  art. 0830026N.C8C
- 24x  art. 0830043N.C8C
- 12x  art. 0830030N.C8C
- 24x  art. 0830051N.C8C



## DISPLAY BOX NAUTICAL 200PCS

Art. 0830141N.C8S

1/1/-



















24x		art. 0830027N.C8S
9x		art. 0830185N.C8S
6x		art. 0830030N.C8S
24x		art. 0830026N.C8S
12x		art. 0830043N.C8S
8x		art. 0830021N.C8S
24x		art. 0830025N.C8S
4x		art. 0830039N.C8C
8x		art. 0830058N.C22
9x		art. 0830055N.C22
12x		art. 0830032N.C8S
12x		art. 0830051N.C22
8x		art. 0830059N.C8S
6x		art. 0832015N.C30
24x		art. 0832005N.C30
4x		art. 0830042N.C8C
6x		art. 0830040N.C8C



## DISPLAY BOX SANDHYA 200PCS

Art. 0830141N.C2E

1/1/-

24x		art. 0830027N.C2E
9x		art. 0830185N.C2E
8x		art. 0830030N.C2E
24x		art. 0830026N.C2E
12x		art. 0830043N.C2E
10x		art. 0830021N.C2E
24x		art. 0830025N.C2E
6x		art. 0830039N.C06
8x		art. 0830058N.C22
9x		art. 0830055N.C34
6x		art. 0830022N.C34
12x		art. 0830032N.C2E
12x		art. 0830051N.C06
8x		art. 0830059N.C2E
4x		art. 0832016N.C06
4x		art. 0832016N.C34
4x		art. 0832016N.C30
18x		art. 0832005N.C43
6x		art. 0830040N.C34



## DISPLAY BOX CUVÉE - RISERVA 82PCS

Art. 0830138N

1/1/-

### WATER

6x	CUVÉE'	art. 0830200N.C71
6x	RISERVA	art. 0830216N.C71

### WHITE

3x	CUVÉE'	art. 0830171N.C71
3x	RISERVA	art. 0830219N.C71

### PROSECCO

4x	CUVÉE'	art. 0830205N.C71
4x	RISERVA	art. 0830217N.C71

### RED

4x	CUVÉE'	art. 0830184N.C71
3x	RISERVA	art. 0830220N.C71

### BEER

4x	MUNICH	art. 0830196N.C71
4x	SPECIAL	art. 0830173N.C71



## DISPLAY BOX FANTASY 60PCS

Art. 0830135N

1/1/-

6x	WATER CUVÉE'	art. 0830200N.C71
3x	WHITE WINE CUVÉE'	art. 0830171N.C71
3x	PROSECCO CUVÉE'	art. 0830205N.C71
3x	RED WINE CUVÉE'	art. 0830184N.C71
4x	BEER PINT	art. 0830210N.C71
4x	BEER SPECIAL	art. 0830173N.C71
4x	OXIGEN	art. 0830208N.C9N
4x	OCTOGLASS	art. 0830207N.C9N
3x	VIAL	art. 0830203N.C71
4x	CARAFFE 0,5L	art. 0830193N.C00
4x	CARAFFE 1L	art. 0830172N.C00
10x	COOL CUBES	art. 0826005N
4x	VINTAGE	art. 0830195N
4x	DIAMOND	art. 0830204N























## DISPLAY BOX COSMIC 195Pcs







Art. 0830141N.C8A  
1/1/-

- 24x  art. 0830027N.C8A
- 8x  art. 0830030N.C8A
- 12x  art. 0830035N.C8A
- 24x  art. 0830026N.C8A
- 12x  art. 0830043N.C8A
- 24x  art. 0830025N.C8A
- 9x  art. 0830185N.C8A
- 6x  art. 0830039N.C8A
- 12x  art. 0830051N.C8A
- 8x  art. 0830058N.C8A
- 12x  art. 0830055N.C8A
- 12x  art. 0830032N.C8A
- 6x  art. 0832016N.C8A
- 12x  art. 0830021N.C8A
- 6x  art. 0830080N.C8A
- 8x  art. 0830059N.C8A



## DISPLAY BOX PRALIN 225Pcs

Art. 0830130N.C6X  
1/1/-

- 48x  art. 0830025N.C6X
- 48x  art. 0830027N.C6X
- 21x  art. 0830185N.C6X
- 48x  art. 0830026N.C6X
- 24x  art. 0830043N.C6X
- 12x  art. 0830030N.C03
- 24x  art. 0830051N.C03



### ENIGMA DINNER PLATE

Art. 0830320N.C5L  
24/24/-



### PANAREA DINNER PLATE

Art. 0830320N.C2X  
24/24/-



### ENIGMA DEEP PLATE

Art. 0830310N.C5L  
24/24/-



### PANAREA DEEP PLATE

Art. 0830310N.C2X  
24/24/-



### ENIGMA SIDE PLATE

Art. 0830330N.C5L  
24/24/-



### PANAREA SIDE PLATE

Art. 0830330N.C2X  
24/24/-



### ENIGMA BOWL

Art. 0830350N.C5L  
24/24/-



### PANAREA BOWL

Art. 0830350N.C2X  
24/24/-



### ENIGMA MUG

Art. 0830140N.C5L  
24/24/-





















### PANAREA MUG

Art. 0830140N.C2X  
24/24/-



## DISPLAY BOX SERENADE 200Pcs

Art. 0830141N.C6A  
1/1/-

- 24x  art. 0830027N.C6A
- 6x  art. 0830030N.C03
- 9x  art. 0830022N.C03
- 24x  art. 0830026N.C6A
- 12x  art. 0830043N.C03
- 24x  art. 0830025N.C6A
- 8x  art. 0830187S.C6A
- 4x  art. 0830039N.C03
- 9x  art. 0830051N.C03
- 6x  art. 0830040N.C03
- 8x  art. 0830058N.C03
- 9x  art. 0830055N.C03
- 12x  art. 0830032N.C6A
- 6x  art. 0832016N.C03
- 6x  art. 0832016N.C06
- 12x  art. 0832005N.C03
- 12x  art. 0832005N.C06
- 9x  art. 0830035N.C6A



**VINIS FOLD-AWAY**

Art. 0203062C.C9N  
1 / 1 / -

**CLEO FOLD-AWAY**

Art. 0203064C.C9N  
12 / 12 / 216

**STAY MAT S**

Art. 0201030N  
24 / 24 / -

**BIKE COVER 2/3**

Art. 7130219N  
4 / 4 / 84

**STAY MAT M**

Art. 0201031N  
24 / 24 / -

**BIKE COVER 4**

Art. 7130210N  
4 / 4 / 72

**BIKE COVER SPECIAL 2/3**

Art. 7130200N  
4 / 4 / 84

**TIDY**

Art. 0203020N  
24 / 24 / -

**BIKE COVER CVN 2**

Art. 7130212N  
4 / 4 / 72

**WC-MASK**

Art. 0402031N  
20 / 160 / -

**E-BIKE COVER 2**

Art. 7130220N  
4 / 4 / 84



# INDICE

## A

Accendino USB	324
Accessori elettrici 12V	354-371
Accessori gas	326,327
Accessori per amache	162
Accessori per gazebo	101
Accessori viaggio	164-169
Adattatori 13 poli	374
Alimentatore elettrico	348
Allarme fughe gas	357
Amache	161-163
Angolari di protezione	388
Appendiabiti a gancio	338
Armadietto pensile	231
Articoli in silicone/TPE	333,313
Aspirapolvere 12V	365,365
Aspirapolvere ricaricabile 230V	364
Aste bloccastoviglie	341
Avvolgicavo	373
Avvolgitubo	382

## B

Bacinelle	330,331
Basi antisfondamento	417
Basi per gazebo	101
Bauli per trasporto	414
Bicchieri	286-295
Bilancia pesabombole	165,356
Bilancia pesatimone	419
Bocca erogazione automatica	379
Boccali inox	352,353
Boccali termici	352
Bollitore elettrico	313,314
Bollitori	314
Bombolette gas	322
Borse Com-Pack	349,350,351
Borse da viaggio	165,166
Borse termiche	349,350,351
Borse trasporto	166,408,409
Bottiglie inox	352,353
Bottiglie termiche	352,353
Bottoni a pressione	122
Brandine	179,198,199

## C

Candele citronella	169
Caffettiera	315
Caraffe	290,291
Carrelli portatutto	205
Carretto portatutto	202,204
Cartelli carichi sporgenti	407
Cassaforte	414
Cassetta portaoggetti	412
Cavi e adattatori	373-375
Cestini pensili	336,337
Cestino portarifiuti	334-337

Cesto multiuso	328
Cinghie di fissaggio	115
Ciotola cani	282
Colapasta	313
Compressore 12V	359
Conchiglie paravento/sole	92-95
Contenitore per zampironi	169
Contenitori portavivande	353
Contenitori termici	315,353
Controllore tensione	375
Coperchi pentole	297
Coperchio per Vinis	330
Coperta di emergenza	166
Coperta in pile	150
Coperte pic-nic	159
Copertura camper	388,389,392
Copertura caravan	390,391,393
Coperture di protezione	398,399 406,407

Copribombola gas	398
Coprioblò	396
Copriredili igienici	168,381
Coprivolante	398
Corde di tensione	113,338
Corde elastiche	115,338
Cubetti ghiaccio	292
Cunei d'arresto	418,419
Cunei di stazionamento	418,419
Cuscini poggiatesta	153,157
Custodie impermeabili	167

## D

Distanziatori coperture	388
Divani	190,191
Detergenti	384,385
Doccia da viaggio	380
Doccia solare	380

## E

Elastici per tende	114
--------------------	-----

## F

Fermateloni/Fermastuoie	123
Fermabauletti	419
Fornelli a gas	320-325
Frigobox elettrici 12/230V	344-348

## G

Ganci	112,118
Gazebi	96-101
Gazebi per Outdoor	88-91
Gazebi pieghevoli	96-101
Ghirbe e taniche	378
Gonfiatore 12V	153,359
Gradini	410,413
Graffe fermateloni	123
Grembiule paravento	399
Griglia di partenza	416
Grill da tavolo	322,323,363
Grill portatili	322,323,363

## I

Imbuto	377
Impermeabilizzanti	384
Insalatiera con posate	278
Inserito per paniere	330
Inverter	355

## K

Kit collegamento tende minibus	119
--------------------------------	-----

## L

Lampada veranda	143,370
Lampade da campeggio	139-141,142
Lampade frontali	143
Lavatrice da viaggio	365
Lavello pieghevole	332
Lettoni da campo	160,196
lettoni da sole	179,198,199
Livelle a bolla	416
Luce armadio	369
Luce entrata	367,368

## M

Martelli da campeggio	116
Martinetti	416
Materassini autogonfianti	152,154
Materassini isolanti	152,153,158
Materassini pneumatici	152,153,155
Materassini ultraleggeri 6 tubi	153
Materassino da spiaggia	152,153,158
Mattonelle ghiaccio	350
Mensole	341
Mepo Box	299,309
Mobiletti cucina	226-235
Mobiletti per tende	226-235
Mobili armadi	226-231
Morsetto di stabilizzazione	79
Morsetti bloccapali	118
Morsetti bloccatiloni	123

## N

Necessaire da viaggio	168
-----------------------	-----

## O

Occhielli	122
Oliera/acetiera	262
Ombrelloni parasole	102-105
Omni-Box	313
Oscuranti termici	394,395 396,397

## P

Pale/zappe	116
Pali supplementari tende	74,117 120,121
Palo antibufera	120
Palo telescopico alluminio	75,119
Paniere multiuso	330
Paravento	94,95
Paravento fornelli	317
Pareti laterali per gazebi	88-91,101
Pareti laterali per tendalini	52,53,61
Pedane	134
Pentolame alluminio	296,309



Pentolame inox	310,312
Phon da viaggio	358
Piastra di cottura	362,317
Piastra di cottura elettrica	362
Piastra grill	323
Picchetti in metallo	108-111
Picchetti in plastica	108,11
Picchetti porta-ombrelloni	105,110,
Pinza prendipentola	310,317
Plafoniere	366
Poggiapiedi	172-185
Poltrone pieghevoli	173,179
Pompe acqua ad immersione	379
Pompe di gonfiaggio	78,156
Poncho impermeabile	166
Portabicchieri	333,341
Portapiatti	341
Portasacchetto rifiuti	334
Portaspezie	262
Portavivande	179,221
Portoggetti	230,231,333
Posacenere	264,268 269,272
Posate	282,284,285
Posate cucina	262,263 268,309
Prodotti chimici	384,385
Profilo di collegamento	78,119
Profilo di scorrimento	78,119
Profilo in alluminio	119
Prolunghe	373
Puntale palo	118
<b>R</b>	
Rete per tavoli	222
Rete portaoggetti	414
<b>S</b>	
Sacche compressione	16
Sacche custodia	325
Sacche impermeabili	167
Sacchetti portarifiuti	335,337,381
Sacchi lenzuolo	150
Sacchiletto	144-151
Sacchetto ultraleggero	151
Saliera/Pepiera	266
Scale pieghevoli	415
Scolapiatti	333
Scopa per tende e verande	340
Secchiello pieghevole	330-332
Secchio multiuso	328,329
Sedie Action	186,188,189
Sedie pieghevoli	172-195
Sedie regista	187
Sedie Relax	173,179
Seggiolone per baby	189
Serbatoi mobili	377
Set paletta/scopetta	340
Sfera bloccatloni	123

Sgabelli	196,197,215
Spazzola lavaggio telescopica	383
Spazzolini WC	383
Specchi retrovisori	420,421
Spiaggine	200,201
Spilloni per tende/verande	110,111,131
Spine e prese 12V	372
Spine e prese 13P	372
Spine e prese 220V	374,375
Staccabatteria	372
Stendibiancheria	338,339
Stoviglie in melamina	238-281
Stufetta a gas	320,321
Stufetta ad aria	360,361
Stufette elettriche	360,361
Stuoia antiscivolo	341
Stuoia spiaggia	158
Stuoie per verande	124-133
Stuoie protezione	124-133
Supporti portapalo	118
<b>T</b>	
Taglieri	271,272,279
Tappeti	402-405
Tappeti cabina	402,-405
Tappetini antiscivolo	402,410
Tappo adattatore con rac- cordo	382
Tavoli da campeggio	206-225
Tavolo sgabello	194,195,197
Tazza inox	282
Telaio portarifiuti	334
Telaio portafrigo	346
Teloni	122,123
Tendalino camper	74,75
Tendalini caravan	76-77
Tende	8-71
Tende cucina	80-85
Tende Family	20-37
Tende Minibus	56-59,63-65
Tende multifunzionali	85,86,87
Tende per porte	136,137
Tende pneumatiche	26-27,30- 33,44-51
Tende portellone posteriore	68-71
Tenditori	112
Tettuccio parasole	147
Tostapane per fornelli	317
Treppiede antenna	415
<b>V</b>	
Ventilatore frigo	355
Ventilatori	358
Ventose per tende minibus	79,112
Ventose per oscuranti termici	394
Veranda gonfiabile	50,51,58,60,
Verande ultraleggere	52,53
<b>W</b>	
WC portatile	381

<b>Z</b>	
Zaini termici	349
Zampironi antizanzare	169
Zanzariera coprivivande	333
Zanzariere	169,333,387
Zanzarikiller	371
Zerbini	135,405
Zampironi antizanzare	163
Zanzariera coprivivande	304
Zanzariere	162,347
Zanzarikiller	331
Zerbini	116,363





## GARANZIA

I prodotti originali Brunner sono realizzati con materiali di ottima qualità, tenendo conto dell'utilizzo al quale verranno normalmente sottoposti. Severi controlli di qualità hanno lo scopo di fornire prodotti privi di difetti di materiale e/o di produzione. In caso si riscontrasse comunque uno dei difetti sopracitati, entra in azione la garanzia del prodotto che ha una durata di 24 mesi dalla data di acquisto.

## ATTENZIONE:

La garanzia non copre difetti dovuti ad un utilizzo improprio o scorretto del prodotto stesso. Sono esclusi dalla garanzia anche difetti causati da un uso particolarmente prolungato del prodotto e dalla normale usura dei componenti che ne consegue.

L'articolo che presentasse i difetti sopra citati, dovrà essere consegnato al punto vendita in cui è stato effettuato l'acquisto, unitamente allo scontrino fiscale comprovante la data di tale transazione.

Il rivenditore provvederà ad effettuare tutte le operazioni necessarie per far pervenire il prodotto difettato alla Brunner srl o al distributore.

- Colori, misure e materiali dei prodotti e degli imballi sono indicativi e non impegnativi. Ci riserviamo di apportare modifiche tecniche ai prodotti illustrati.

Attenzione: i colori dei prodotti possono differire dall'originale per motivi tipografici. Non rispondiamo per eventuali errori di stampa.

- E' vietata la riproduzione, anche parziale, di testi, schemi, grafiche ed immagini contenuti nel presente catalogo.
- L'oggettistica decorativa non è compresa nel prezzo indicato.
- Diritti riservati. Questo catalogo o ogni sua parte non può essere riprodotto senza l'autorizzazione della ditta Brunner s.r.l.





**Benelux**

GIMEG  
Strijkviertel 27  
NL - 3454 PH De Meern  
T: +31(0) 30 662 9500  
F: +31(0) 30 666 5397  
sales@gimeg.nl  
www.gimeg.nl

**Finland**

Keha Caravan Tukku Oy  
Koskelontie 15  
FIN-2920 Espoo  
T: +358 40 7794595  
palaute@caravantukku.fi  
www.carvantukku.fi

**Iceland**

VIKURVERK EHF  
Vikurhvarf, 6  
203 Kópavogur  
T: +354 557 7720  
F: +354 567 4357  
www.vikurverk.is

**Poland**

GoMarket.pl  
Ul. Wybrzeze Gdynskie 2  
PL-01-531 Warszawa  
T: +48 (0)22 8392024  
F: +48 (0)22 7744745  
biuro@gomarket.pl  
www.gomarket.pl

**Sweden**

DCT Vejle A/S  
Knud Højgaards Vej 2  
DK-7100 Vejle Denmark  
T: +45 7582 4800  
F: +45 7582 2400  
dct@dct-vejle.dk  
www.dct-vejle.dk

Kama Fritid AB  
Momarken 3  
SE-556 50 Jönköping  
T: +46.36.353723  
info@kamafritid.se  
www.kamafritid.com

**Croatia**

Meridian Nautika d.o.o.  
Camping-Nautic-Outdoor  
Mate Vlašića 24/A  
HR - 52440 POREČ  
T: +385(0) 52 453 096  
F: +385(0) 52 428 546  
info@meridian.hr  
www.meridian.hr

**France**

Brunner srl/GmbH  
Via B. Buozzi, 8  
I - 39100 Bolzano  
T: +39 0471 542900  
F: +39 0471 542905  
info@brunner.it

**Israel**

LAOFEK CARAVAN & CAMPING  
6 Hayetzira Street  
IL - 4951232 Petah-Tikva  
T: +972-3-744-3344  
F: +972-73-729-4444  
info@laofek.co.il  
www.laofek.co.il

**Slovenja**

TECA D.o.o  
Cesta Ljubljanske Brigade, 9  
SI - 1000 Ljubljana  
T: +386 1 5838030  
F: +386 1 5185375  
info@teca.si  
www.caravan.si

**United Kingdom**

Brunner UK  
c/o Simon Cornall Associates Limited  
95 Birmingham Road  
Allesley Village  
Coventry  
CV5 9GT  
M: +44(0) 7931 248748  
simonbrunneruk@gmail.com

Miriad Products  
Dove Valley Park  
GB-Foston-South Derbyshire DE65 5BG  
T: +44(0) 1283 586060  
F: +44(0) 1283 586061  
info@miriad-products.com  
www.miriad-products.com

**Czech Republic**

Brunner srl/GmbH  
Via B. Buozzi, 8  
I - 39100 Bolzano  
T: +39 0471 542900  
F: +39 0471 542905  
info@brunner.it

**Germany Austria Switzerland**

Brunner srl/GmbH  
Buozzistrasse 8  
I - 39100 Bozen  
T: +39 0471 542900  
F: +39 0471 542905  
info@brunner.it

**New Zealand**

Burnsco  
PO Box 54 035  
Bucklands Beach 2144  
Auckland  
New Zealand  
T: 0800 10 20 40  
www.burnsco.co.nz

**Denmark**

DCT Vejle A/S  
Knud Højgaards Vej 2  
DK-7100 Vejle Denmark  
T: +45 7582 4800  
F: +45 7582 2400  
dct@dct-vejle.dk  
www.dct-vejle.dk

**Greece**

ZAMPETAS  
18 KLM Thessalonikis – Perea  
570 19 Perea  
T: 0030 23920 71760  
F: 0030 23920 71761  
www.zampetas.gr

**Norway**

CARAVAN SUPPLY AS  
Teglverksveien 100  
N – 3057 Solbergelva  
T: +47 32885533  
post@casu.no  
www.casu.no

**Spain and Portugal**

Casmat Sport, S.L  
Poligono Industrial Can Roses  
Ctra. Molins a Sabadell, km 13, nave 21  
08191 Rubi (Espana)  
T: +34 93 588 75 39  
F: +34 93 588 34 98  
info@casmatsport.com  
www.casmatsport.com

**Turkey**

Akkale Dekorasyon  
San. Ve Tic. Limited Sirketi  
Gürpınar Mah. 7237 sokak No:27/A  
Bornova/ Izmir  
T: +90 232 437 31 05  
Info@akkale.com.tr

**Brunner International  
Head Office • Italy**

Brunner srl/GmbH  
Via B. Buozzi, 8 • Buozzistrasse 8  
I - 39100 Bolzano • Bozen  
T: +39 0471 542900  
F: +39 0471 542905  
info@brunner.it

**Brunner International  
Hong Kong**

CampNow International LTD.  
Room 1402, 14/Floor,  
Yu Song Boon Building  
107-111 Des Voeux Road Central,  
Hong Kong  
brunnerasia@brunnerinternational.com



A company from  
**südtirol**