

CATALOGO 2023



Enjoy
THE
EXPERIENCE

Plastic free Packaging
Il nostro impegno

Equiframe
La sicurezza innanzitutto

Perfect for vans
Il più compatto possibile

2023

UNA NUOVA STAGIONE. UN NUOVO CAPITOLO. IL NUOVO NOI.

Siamo convinti che i momenti trascorsi insieme all'aria aperta siano quelli che durano tutta la vita. Che si tratti di prendere il sole in spiaggia, di trascorrere un bel pomeriggio in bicicletta o di fare un barbecue con gli amici camperisti la sera, le ore e i giorni trascorsi all'aria aperta rappresentano alcuni dei ricordi più preziosi.

Ecco perché, anno dopo anno, il nostro team sviluppa nuovi prodotti outdoor che catturano questi momenti di felicità. Con una mentalità mirata e una passione per le soluzioni funzionali e pratiche, il nostro obiettivo è quello di creare accessori fantastici che migliorino la vostra esperienza all'aria aperta.

Combinando il design italiano con il know-how produttivo in diversi Paesi del mondo, siamo in grado di sviluppare, presentare e produrre nuovi prodotti outdoor in modo continuo. Prodotti che apprezzerete fin da subito e per molto tempo.

Con passione dall'Alto Adige al resto del mondo e viceversa,

Il vostro team Brunner Outdoor

















Team Brunner



CATALOGUE

CONTENT

LIFESTYLE

1		INTRO	2
2		TENTS	8
3		GAZEBOS & BEACH PARASOLS	76
4		CAMPING ACCESSORIES	86
5		FLOOR & DOOR	104
6		LAMPS & LANTERNS	118
7		SLEEP & RELAX	124
8		TRAVEL ACCESSORIES	144
9		OUTDOOR FURNITURE	150
10		TABLE & KITCHEN	214
11		GAS ITEMS	296
12		HOUSEHOLD	306
13		COOLING	320
14		ELETRICAL PRODUCTS	332
15		WATER & SANITATION	354
16		TECHNIQUE	364



MIX & MATCH

Coordina per forma e colore.

Arreda in modo accogliente il tuo ambiente Outdoor e donagli un tocco di lusso. La vastità di colori e forme dei prodotti presenti nel catalogo Brunner rendono possibile un allestimento del tutto individuale senza rinunciare però alla fantastica armonizzazione di prodotti di diverse categorie merceologiche.

Createvi il vostro ambiente personale - come a casa vostra!



ARAVEL 3D
p. 156



MERCURY CROSS
COOKER HWT SQUARE
p. 209



CAMPERKING
p. 198



POLARYS
TRAVEL
p. 326



ENJOY THE EXPERIENCE



Tre parole speciali che hanno un significato differente per ogni persona che le legge. Ispirati dal bisogno delle persone a muoversi, abbiamo speso decenni a inventare, re-inventare e ottimizzare equipaggiamenti utili per tutti coloro che amano spendere il loro tempo libero in qualsiasi tipo di attività outdoor. Questo ci ha portati a realizzare una gamma di prodotti di alta qualità adatti per adeguarsi ai vostri bisogni e assicurare soddisfazione indipendentemente dai luoghi, dal clima e dalle condizioni meteorologiche. Combinando design e funzionalità realizziamo prodotti che rendono la vita outdoor un'esperienza emozionante senza fine.



INNOVATIONS



NUOVO O INNOVATIVO?

L'INNOVAZIONE ISPIRA E STIMOLA LA RICERCA DEL NUOVO.

Il nuovo, che aiuta l'uomo a rendere la propria vita più semplice, più confortevole e più sicura. L'innovazione è l'impulso che incita e ispira la ricerca, che la colma di capacità e saggezza.

L'acquisto di una nuova attrezzatura è un'importante decisione fatta sulla base di vari fattori come funzionalità, design, qualità, lavorazione ed il rapporto qualità/prezzo. Anche quest'anno il catalogo Brunner Outdoor 2023 propone una varietà di novità nei vari settori. Una varietà che aspetta di essere scoperta, provata e combinata per forme e colori. Sfogliate comodamente il catalogo oppure visitate il catalogo online, per trovare prodotto e prezzo più adatti alle vostre esigenze.

QUADRA COMPACT 2023 ORIGINAL DESIGN & ENGINEERING



originaldesign



PLASTIC FREE

Brunner Outdoor vuole essere in prima linea nell'impegno verso un mondo più pulito. È per questo che siamo orgogliosi di aver dato inizio ad un processo che nell'arco di 3-5 anni porterà ad un azzeramento del packaging commerciale realizzato in materiale plastico. Questa processo che, oltre a portare benefici concreti, si pone l'obiettivo di ulteriormente sensibilizzare la cultura del rispetto per il nostro pianeta di tutti gli amanti Outdoor, peraltro già particolarmente sensibili a questa tematica.



OUR PATENTS

I NOSTRI BREVETTI

I brevetti sono rappresentativi dell'inventiva e della voglia di innovazione di un'azienda e indubbiamente utilissimi per migliorare la prestazione dei prodotti.

Alcuni dei nostri articoli, come ad esempio le popote con sistema Magnetogrip, che definiscono un nuovo standard funzionale e offrono ai camperisti il massimo comfort in termini di utilizzo, sono stati brevettati in vari paesi con lo scopo di proteggere la nostra esperienza e conoscenza.



MAGNETO GRIP

IMPROVEMENTS



Il continuo sviluppo
e l'ottimizzazione
dei nostri prodotti rende
**L'ESPERIENZA
OUTDOOR
SICURA E
CONFORTEVOLE**



UTILIZZO SICURO

La sicurezza del consumatore finale è un elemento fondamentale della politica prodotti Brunner.

ALCUNI ESEMPI:

- Il rispetto della normativa Reach
- Il rispetto della certificazione CE
- Tessuti ignifughi
- L'utilizzo di meccaniche antiinfortunistiche
- Collaudi TÜV/GS



⟨M⟩
mountless

OUR SYSTEMS

Goditi l'installazione rapida e senza problemi della tua attrezzatura Outdoor grazie ai nostri eccezionali sistemi MOUNTLESS.

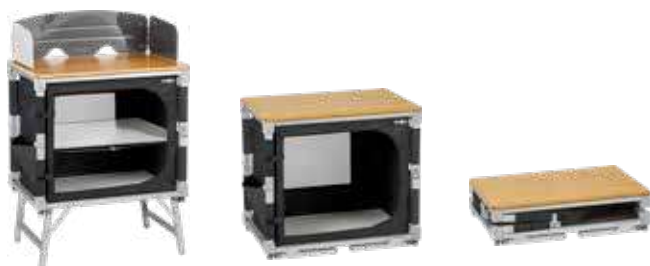

⟨O⟩
oneflate

OUR SYSTEMS

Le tende e i gazebo A.I.R.Tech con tecnologia ONEFLATE dispongono di camere d'aria interconnesse, gonfiabili tramite una sola valvola di ingresso dell'aria.





USED ICONS

Misure aperto	Misure chiuso	Misure	Peso
Portata	Tessuto	Sopratelo	Abitacolo
			Δt
Catino	Misure abitacolo	Struttura	Differenziale termico
Paleria interna	Paleria esterna	Colonna d'acqua	Cuciture sigillate
l/min			
Litri al minuto	Uso alimentare	Temperatura	Strati
Imbottitura	Custodia	Tessuto interno	Tessuto esterno
P	V		alu
Potenza	Volume	Funzionamento	Alluminio
steel	alu hybrid	p	
Acciaio	Alluminio / Acciaio	Pressione	Tempo / durata
Attacco gas	LED	Lumen	Autonomia batteria



USED EXPLICATIVE LOGOS



WEB SUPPORT



**SCOPRI IL NUOVO SITO BRUNNER
E IMPARA A CONOSCERE LE IDEE
CHE STANNO DIETRO AI NOSTRI PRODOTTI**

Un sacco di idee ed innovazioni che rivoluzionano l'avventura Outdoor ed un sacco di informazioni sulla gamma di prodotti Brunner.

Lasciati ispirare e metti insieme la tua attrezzatura in modo tale che soddisfi le tue esigenze e le tue aspettative. Resterai sorpreso dalla moltitudine di nuovi prodotti, dalle ottimizzazioni e dalle tante piccole migliorie, perché sono sempre i dettagli che fanno la differenza.

Web Site
QR code



brunneroutdoor.com

FOLLOW US

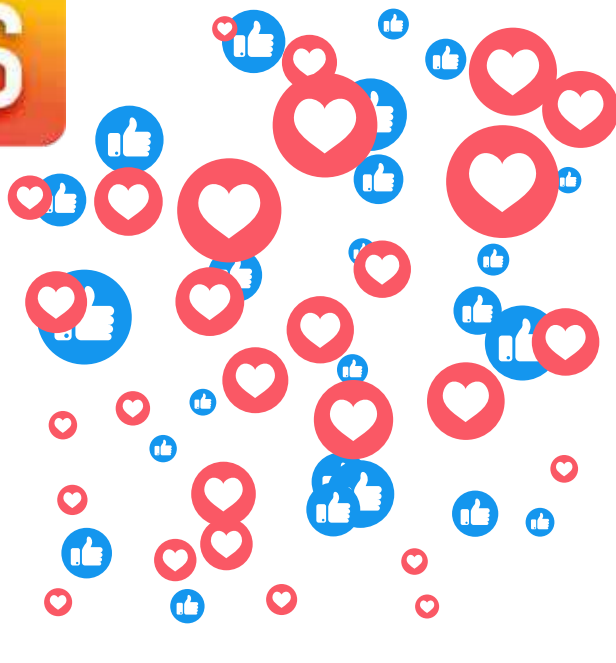

fb.me/brunneroutdoor



instagram.com/brunneroutdoorofficial/



youtube.com/@BrunnerOutdoor



TENTS

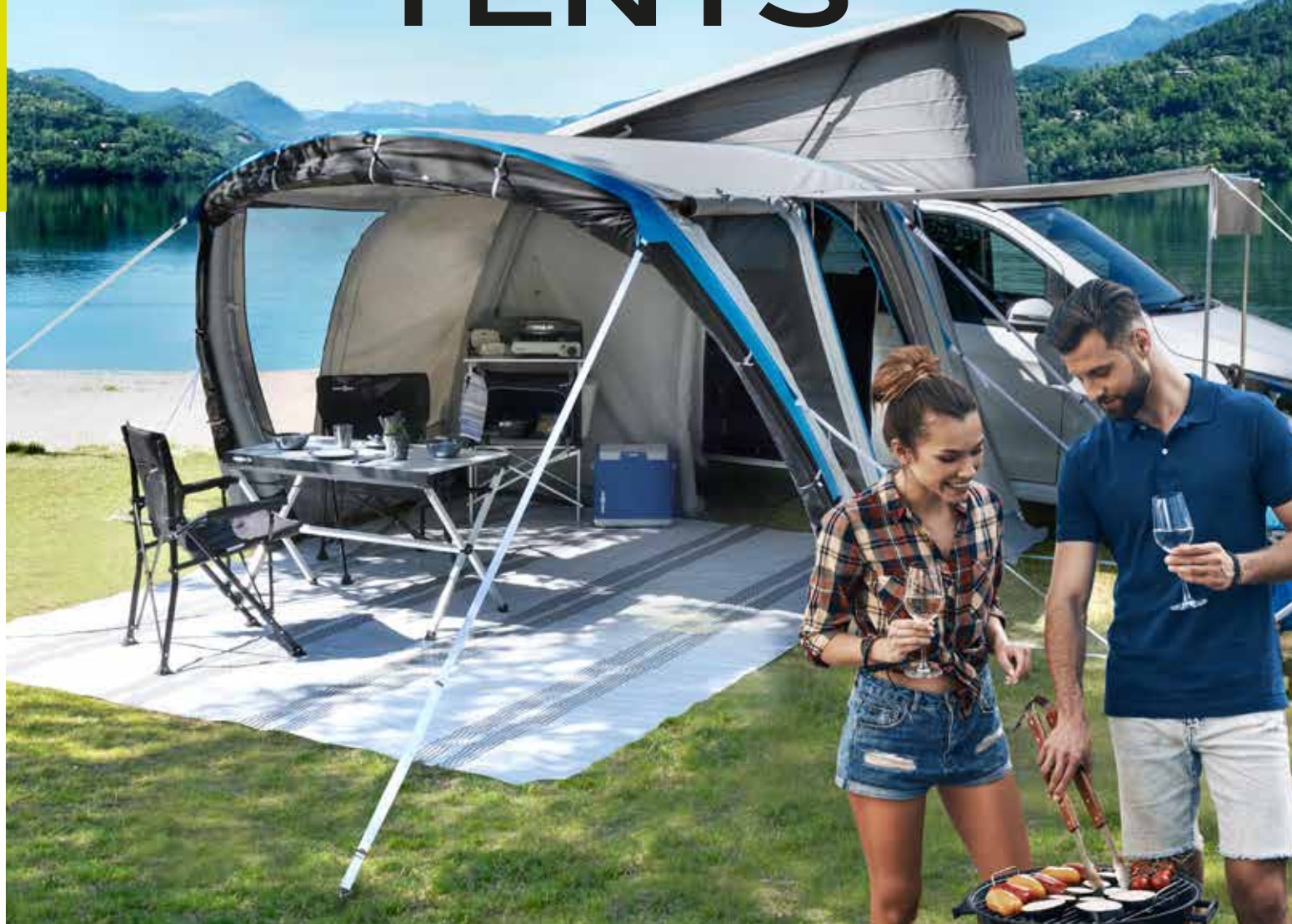

LA TENDA MODERNA IN TUTTE LE SUE VARIANTI

La tenda rappresenta un'importante interfaccia dell'uomo con l'ambiente circostante, essa gioca un ruolo decisivo sullo stato del benessere degli occupanti durante il periodo del suo utilizzo. Già un modello Family medio garantisce un livello di comfort impensabile fino a pochi anni fa. Comfort che è diventato un elemento decisivo per l'apprezzamento ed il successo stesso del prodotto e che si caratterizza per:

- Materiali utilizzati
- Spazio interno, utilizzabile anche in caso di cattivo tempo
- Spazio per cucinare
- Velocità di montaggio
- Dotazioni comfort di serie (catino incernierato, entrate cavi elettrici, nastri fissacavi, tetti parapioggia, ecc.)
- Peso



PANORAMICA MODELLI TENDE

- P. 22-23 Tende Family A.I.R.Tech in policotone
- P. 24-25 Tende Family A.I.R.Tech in poliestere
- P. 26-27 Tende Family classiche in poliestere
- P. 28-29 Tende Touring in poliestere
- P. 30-31 Tende Automatic in poliestere
- P. 32-37 Tende Minibus A.I.R.Tech in policotone
- P. 38-39 Tettucci Parasole A.I.R.Tech in policotone
- P. 40-43 Tende Minibus A.I.R.Tech in poliestere
- P. 44 Verande Caravan A.I.R.Tech in poliestere
- P. 45 Tettucci parasole A.I.R.Tech in poliestere
- P. 46-49 Tende Minibus classiche in poliestere
- P. 50-53 Tende posteriori in poliestere
- P. 54-56 Tettucci parasole in poliestere / politene
- P. 57 Tettucci parasole Caravan in poliestere
- P. 60-67 Cucinotti e tende storage
- P. 68-71 Gazebi Outdoor
- P. 72-73 Conchiglie parasole
- P. 74-75 Paravento





PURE 4
P. 23



PARAISO 5/6
P. 25

TIPO MONTAGGIO

PRIMA SOPRATELO

Numero persone	4	5/6
Altezza cm	210	215
Tessuto sopratelo	Polycotton	Oxford Polyester
Colonna d'acqua mm	-	3000
Spalmatura	-	PU
Nastratura sopratelo	-	•
Apertura aerazione	•	•
Balza perimetrale	•	-
Tessuto abitacolo	Polycotton traspirante	Poliestere traspirante
Abitacolo Creanox	•	•
Divisorio abitacolo	•	•
Paleria	Airtube	Airtube
Paleria precollegata	-	-
Paleria con segnalini colorati	-	-
Fissaggio paleria Ring-Pin	•	-
Regolazione punti di ancoraggio	•	•
Pali verticali veranda	•	•
Numero entrate	2	2
Finestre Airama	•	-
Finestre Panorama	•	•
Stuoia veranda	-	-
Catino cucito a chiusura totale	•	•
Zanzariera entrata abitacolo	•	•
Zanzariera ingressi	•	•
Ingresso cavo sopratelo	•	•
Ingresso cavo abitacolo	•	•
Rinforzi punti max. sollecitazione	•	•
Tasche interne	•	•
Gancio appendilampada	•	•
Corde tensione prefissate	•	•
Corde tensione riflettenti	•	•
Accessori di montaggio	•	•
Sacca custodia	•	•



KALYNDIA 5
P. 26



ARQUS 5
P. 27

TIPO MONTAGGIO

PRIMA SOPRATELO

Numero persone	5	5
Altezza cm	205	205
Tessuto sopratelo	150D Oxford Polyester	Polyester
Colonna d'acqua mm	3000	3000
Spalmatura	PU	PU
Nastratura sopratelo	•	•
Apertura aerazione	•	-
Balza perimetrale	-	-
Tessuto abitacolo	Poliestere traspirante	Poliestere traspirante
Abitacolo Creanox	•	•
Divisorio abitacolo	•	•
Paleria	Fiberglass	Fiberglass
Paleria precollegata	•	•
Paleria con segnalini colorati	•	•
Fissaggio paleria Ring-Pin	•	•
Regolazione punti di ancoraggio	•	•
Pali verticali veranda	•	•
Numero entrate	1	2
Finestre Airama	•	•
Finestre Panorama	•	-
Stuoia veranda	-	-
Catino cucito a chiusura totale	•	•
Zanzariera entrata abitacolo	•	•
Zanzariera ingressi	•	•
Ingresso cavo sopratelo	•	•
Ingresso cavo abitacolo	•	•
Rinforzi punti max. sollecitazione	•	•
Tasche interne	•	•
Gancio appendilampada	•	•
Corde tensione prefissate	•	•
Corde tensione riflettenti	•	•
Accessori di montaggio	•	•
Sacca custodia	•	•



STRATO 2
P. 28



GLOBO 3
P. 29



STRATO 2 AUTOMATIC
P. 30



BLITZ 3 AUTOMATIC
P. 31

TIPO MONTAGGIO	MONO TELO		PRIMA SOPRATELO	
Numero persone	2	3	2	3
Altezza cm	105	130	105	120
Tessuto sopratelo	Polyester	68D Polyester	Polyester	Polyester
Colonna d'acqua mm	1000	2000	1500	1200
Spalmatura	PU	PU	PU	PU
Nastratura sopratelo	•	•	•	•
Apertura aerazione	•	•	•	•
Balza perimetrale	-	•	-	-
Tessuto abitacolo	-	Poliestere traspirante	Poliestere traspirante	Poliestere traspirante
Divisorio abitacolo	-	-	-	-
Paleria	Fiberglass	Fiberglass	Fiberglass	Fiberglass
Paleria precollegata	•	•	•	•
Paleria con segnalini colorati	-	•	AUTOMATIC	AUTOMATIC
Fissaggio paleria Ring-Pin	•	•	-	-
Regolazione punti di ancoraggio	-	-	-	-
Pali verticali veranda	•	-	-	-
Numero entrate	1	1	1	1
Finestre Airama	-	-	-	-
Finestre Panorama	-	•	-	-
Stuoia veranda	-	•	-	-
Catino cucito a chiusura totale	-	-	•	•
Zanzariera entrata abitacolo	•	-	•	•
Zanzariera ingressi	-	•	-	-
Ingresso cavo sopratelo	-	-	-	-
Ingresso cavo abitacolo	-	-	-	-
Rinforzi punti max. sollecitazione	-	•	-	-
Tasche interne	•	•	•	•
Gancio appendilampada	•	•	•	•
Corde tensione prefissate	-	•	-	-
Corde tensione riflettenti	-	•	-	-
Accessori di montaggio	•	•	•	•
Sacca custodia	•	•	•	•



AIR TRAVEL II
P. 34



ADVANTOURER
P. 36

TIPO MONTAGGIO

PRIMA SOPRATELO

Numero persone	-	-
Altezza cm	210	230
Tessuto sopratelo	Polycotton	Polycotton
Colonna d'acqua mm	-	-
Spalmatura	-	-
Nastratura sopratelo	•	•
Apertura aerazione	-	•
Balza perimetrale	•	•
Tessuto abitacolo	-	-
Divisorio abitacolo	-	-
Paleria	Airtube	Airtube
Paleria precollegata	-	-
Paleria con segnalini colorati	-	-
Fissaggio paleria Ring-Pin	-	-
Regolazione punti di ancoraggio	•	•
Pali verticali veranda	-	-
Numero entrate	2	2
Finestre Airama	-	-
Finestre Panorama	•	•
Stuoia veranda	•	-
Catino cucito a chiusura totale	-	•
Zanzariera entrata abitacolo	-	-
Zanzariera ingressi	•	-
Ingresso cavo sopratelo	-	-
Ingresso cavo abitacolo	-	-
Rinforzi punti max. sollecitazione	•	-
Tasche interne	-	-
Gancio appendilampada	•	-
Corde tensione prefissate	•	-
Corde tensione riflettenti	-	-
Accessori di montaggio	•	•
Sacca custodia	•	•



TRAILS LC/HC
P. 40



TROUPER 2.0
P. 42



TROUPER XL
P. 43



ALICE
P. 44

TIPO MONTAGGIO

PRIMA SOPRATELO

Altezza cm	215	230	230	250
Tessuto sopratelo	Oxford Polyester	150D Oxford Polyester	150D Oxford Polyester	300D Polyester Oxford
Colonna d'acqua mm	3000	3000	3000	3000
Spalmatura	PU	PU	PU	PU
Nastratura sopratelo	•	•	•	•
Apertura aerazione	•	•	•	•
Balza perimetrale	-	•	•	•
Paleria	Airtube	Airtube	Airtube	Airtube
Regolazione punti di ancoraggio	•	•	•	-
Numero entrate	2	2	2	3
Finestre Panorama	•	•	•	-
Catino cucito a chiusura totale	•	•	•	-
Ingresso cavo sopratelo	-	-	-	-
Accessori di montaggio	•	•	•	•
Sacca custodia	•	•	•	•





BEYOND
P. 46



RAMBLER
P. 47



ENTRADA
P. 48



ALBATROS
P. 49

TIPO MONTAGGIO

PRIMA SOPRATELO

Altezza cm	210	220	210	210
Tessuto sopratelo	68D Polyester	68D Polyester	68D Polyester	Pigment Polyester
Colonna d'acqua mm	3000	3000	3000	3000
Spalmatura	PU	PU	PU	PU
Nastratura sopratelo	•	•	•	•
Apertura aerazione	•	•	•	•
Balza perimetrale	•	-	•	•
Paleria	Fiberglass	Fiberglass	Fiberglass	Fiberglass
Paleria precollegata	•	•	•	•
Fissaggio paleria Ring-Pin	•	•	-	•
Regolazione punti di ancoraggio	•	•	•	•
Numero entrate	2	2	2	2
Finestre Panorama	•	•	•	•
Catino incernierato	•	-	-	-
Catino cucito a chiusura totale	-	•	-	•
Ingresso cavo sopratelo	-	-	-	-
Accessori di montaggio	•	•	•	•
Sacca custodia	•	•	•	•





PILOTE
P. 50



PILOTE 5
P. 51



COMET
P. 52



ESCAPE
P. 53

TIPO MONTAGGIO

Altezza cm	170	170	205	195
Tessuto sopratelo	150D Oxford Polyester	150D Oxford Polyester	150D Oxford Polyester	150D Oxford Polyester
Colonna d'acqua mm	3000	3000	3000	3000
Spalmatura	PU	PU	PU	PU
Nastratura sopratelo	•	•	•	•
Apertura aerazione	-	-	•	•
Balza perimetrale	•	•	•	•
Paleria	-	-	-	-
Paleria precollegata	-	-	-	-
Fissaggio paleria Ring-Pin	-	-	-	-
Regolazione punti di ancoraggio	•	•	•	•
Numero entrate	1	1	2	1
Finestre Panorama	•	•	•	•
Catino incernierato	-	-	-	-
Catino cucito a chiusura totale	-	-	-	-
Ingresso cavo sopratelo	-	-	-	-
Accessori di montaggio	•	•	•	•
Sacca custodia	•	•	•	•





CHEF 2

P. 61



DINERY

P. 61

VIDA 1 NG
VIDA 2 NG

P. 62

GUSTO 1 NG
GUSTO 2 NG
GUSTO 3 NG

P. 63

Misure cm	200x200	240x240	200x150 200x200	150x150 200x150 200x200
Altezza cm	190/230	190/230	195/215	195/215
Tetto	100% Polyester	100% Polyester	100% PVC	100% PVC
Pareti laterali	100% Polyester	100% Polyester	100% Polyester	100% Polyester
Spalmatura	PU	PU	PU	PU
Finestre Panorama	-	•	•	•
Finestre con zanzariera	•	•	•	•
Finestre oscurabili	•	•	•	•
Paleria	Fiberglass / Acciaio	Fiberglass / Acciaio	Acciaio	Acciaio
Ventilazione permanente	•	•	•	•
Numero entrate	1	1	1	1
Catino cucito	-	-	-	-
Catino incernierato	-	-	-	-
Balza perimetrale	•	•	•	•
Tasche interne	-	-	-	-
Accessori di montaggio	•	•	•	•
Sacca custodia	•	•	•	•





CAMP INN

P. 64



CORIANDER 1
CORIANDER 2

P. 65

Misure cm	220x160	200x150 200x200
Altezza cm	195/220	195 210
Tetto	100% PVC	100% PVC
Pareti laterali	100% PVC	100% PVC
Spalmatura	-	-
Finestre Panorama	•	•
Finestre con zanzariera	•	•
Finestre oscurabili	•	•
Palaria	Acciaio	Acciaio
Ventilazione permanente	•	•
Numero entrate	1	1
Catino cucito	-	-
Catino incernierato	-	-
Balza perimetrale	•	•
Tasche interne	-	-
Accessori di montaggio	•	•
Sacca custodia	•	•





CABINA 2 NG

P. 66



CABINA MAXI

P. 66



SANITY

P. 67



STORAGE PLUS

P. 67

	CABINA 2 NG P. 66	CABINA MAXI P. 66	SANITY P. 67	STORAGE PLUS P. 67
Misure cm	140x140	180x160	140x160	225x160
Altezza cm	205	205	213	175/195
Tetto	100% Polyester	100% Polyester	100% Polyester	100% PVC
Pareti laterali	100% Polyester	100% Polyester	100% Polyester	100% Polyester
Spalmatura	PU	PU	PU	PU
Finestre Panorama	-	-	-	-
Finestre con zanzariera	•	•	•	-
Finestre oscurabili	•	•	•	•
Paleria	Fiberglass	Fiberglass	Acciaio	Acciaio
Ventilazione permanente	•	•	•	-
Numero entrate	1	1	1	1
Catino cucito	-	-	-	•
Catino incernierato	-	-	-	-
Balza perimetrale	•	•	•	•
Tasche interne	•	•	-	•
Accessori di montaggio	•	•	•	•
Sacca custodia	•	•	•	•



LA CLASSICA TENDA FAMILY

Una tenda si trasforma nella casa di famiglia durante le vacanze in campeggio. Quindi non c'è dubbio che debba essere adatta anche alla famiglia stessa. Mentre le coppie con un figlio non hanno bisogno di troppo spazio, le famiglie con tre figli o quelle che viaggiano con i nonni, hanno bisogno di spazio sufficiente per dormire comodamente, spazio per riporre attrezzature e bagagli, una saletta per giocare in caso di maltempo e spazio per un tavolo da pranzo con sedie. Le tende Family sono generalmente più grandi, progettate per tempi di permanenza più lunghi, per un maggior numero di persone ed offrono più comfort di una pura "tenda per il pernottamento".

Gli ingressi con altezza e le grandi finestre panoramiche sono una chiara caratterizzazione. L'interno delle tende Family è diviso in una zona notte e una zona giorno. Quest'ultima è di norma così spaziosa che è possibile sedersi insieme intorno al tavolo da campeggio mentre si prepara il cibo e i bambini si riposano nelle cabine letto. C'è molto spazio per tutti gli accessori che rivestono un ruolo importante per il successo di una piacevole vacanza.

Nelle pagine seguenti presentiamo una varietà di modelli che soddisfano le diverse esigenze; come il numero di persone, il peso, le dimensioni, l'altezza, le dimensioni dell'imballaggio, la ventilazione, ecc.

Ci dovrebbe essere qualcosa di adatto ad ogni esigenza.

Quindi: leggetele attentamente, ordinate dal vostro rivenditore e la divertente vacanza in campeggio può iniziare!





POLYCOTTON TENTS



INNOVAZIONE PER UN FUTURO PIÙ CONFORTEVOLE

La sfida principale degli ultimi anni si è concentrata sulla ricerca di materiali che ci permettessero la costruzione di telai pneumatici ad alta pressione rivoluzionari in grado di sostituire i tradizionali pali metallici o in fibra di vetro. L'idea dominante era quella di togliere la complessità dalle operazioni di montaggio delle tende e di offrire all'utilizzatore un elevato livello di semplicità e comfort.



I VANTAGGI DELLE TENDE IN POLICOTONE



**Breathable
Fabric**



**Prevents
Condensation**



Longevity



UV protection

Uno dei principali vantaggi delle tende in policotone è la maggiore traspirabilità e la capacità di adattarsi alle diverse condizioni dell'ambiente circostante.

Questo significa semplicemente che quando fa caldo, l'interno della tenda rimarrà più fresco rispetto alle tende in poliestere. Al contrario, con temperature più basse, la vostra tenda sarà più calda.

Traspirabilità significa anche che il policotone previene e riduce la formazione di condensa permettendo all'umidità di passare attraverso il tessuto, eliminando la sgradevole sensazione di umidità e garantendo benessere e comfort.

L'utilizzo del tessuto di policotone è altresì un investimento nella longevità della tenda. Il policotone offre una resistenza ai raggi UV molto più elevata rispetto al poliestere e il deterioramento dovuto agli effetti dell'invecchiamento è fortemente ridotto.

Nel complesso i tessuti in policotone garantiscono ottima funzionalità, traspirabilità e longevità, un mix interamente tecnologico per un prodotto che vi regalerà piacere nel tempo.











PURE 4



PURE 4

Art. 0102972N

€ 1578,50

-  Polycotton
-  Breathable Polycotton
-  210 x 280 x H195 cm
-  PE
-  630 x 310 x H210 cm
-  AIRTUBE
-  37,6 kg
-  85 x Ø 44 cm

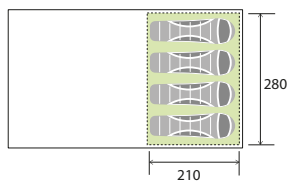
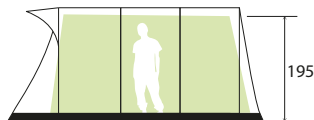
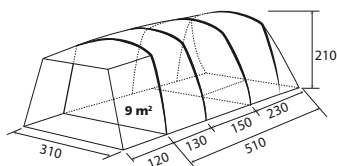

 4x **<M>**
mountless

a.i.r.
tech
air inflation raising

CREAΠOX Info p. 25

Pure 4 A.I.R. Tech Authentic è un eccezionale modello di tenda per famiglie in cerca di molto spazio abitativo. Il tessuto traspirante in policotone mantiene l'interno notevolmente più fresco nelle calde giornate estive, soprattutto quando si trascorrono le vacanze nei climi più caldi. L'ampio verandino frontale garantisce un grande spazio per l'arredamento. Pali verticali inclusi.





POLYESTER TENTS



INNOVAZIONE PER UN FUTURO PIÙ CONFORTEVOLE



I VANTAGGI DELLE TENDE IN POLIESTERE



Premesso che esiste una quantità elevatissima di tessuti in poliestere e che per la realizzazione di materiali di alta qualità impiegati nell'Outdoor vengono utilizzate altre qualità che per semplici magliette o camicie, il poliestere si è rivelato un ottimo materiale per le seguenti ragioni: leggerezza, alta resistenza a strappi ed usura, buona resistenza UV, bassa dilatazione anche in condizioni di umidità.

a.i.r.
tech
air inflation raising



100%
Polyester
Oxford

PARAISO 5/6

Art. 0102981N

€ 1099,00

PARAISO

▲ Polyester Oxford PU 100% Polyester

▲ Breathable Polyester

▲ (140+210) x 215 x H195 cm

▲ PE

▲ 540 x 380 x H215 cm

▲ AIRTUBE

▲ 24,8 kg

▲ 80 x Ø 35 cm

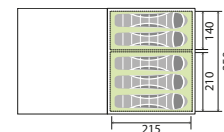
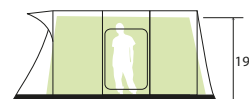
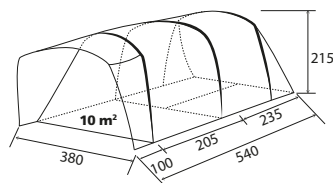

3000mm
5/6x
CREANOX

La tenda Family pneumatica A.I.R. Tech Paraiso unisce in modo perfetto elementi di design moderno, tecnica di costruzione e funzionalità a 360 gradi. Grazie alle grandi aperture di aerazione ed alle ampie finestre panoramiche che sfiorano il catino, viene sempre garantito un ottimo livello di ventilazione interna. Numerosi ed utili dettagli funzionali fanno sì che la Paraiso si monti con sorprendente velocità e facilità e che rappresenti, anche per questa ragione, il compagno perfetto per delle vacanze spensierate e divertenti.

CARATTERISTICHE:

- Struttura pneumatica molto stabile
- 3 tubi aria indipendenti sistema A.I.R. Tech
- Catino a cucitura perimetrale
- Parete frontale rimovibile
- Grandi finestre Airama
- Tetto abitacolo con sistema Creanox
- Porta laterale dotata di zanzariera
- Ventilazione interna efficace
- Ampia veranda anteriore
- Con pompa a mano di alta qualità
- Sono inclusi picchetti in materiale plastico, corde tensione e borsa per il trasporto



INFO

CREANOX



Brunner Creanox è un nuovo sistema per tutti coloro il cui sonno è influenzato dalla luce del giorno. Creanox filtra gran parte della luce diurna e consente un sonno più lungo e riposante - in qualsiasi momento della giornata. Tutte le tende della collezione Brunner Family dotate del sistema Creanox sono contrassegnate in questo catalogo con un logo speciale.



100% Polyester
Oxford

KALYNDA

KALYNDA 5

Art. 0102999N

€ 599,00

Tenda Family con struttura classica a 3 archi e catino integrato in resistente tessuto PE.

150D Oxford Polyester PU (100% Polyester)

Breathable Polyester

(200+140) x 220 x H195 cm

PE

Fiberglass / Steel

External Poles

18 kg

80 x Ø 27 cm

3000 mm
 5x

CARATTERISTICHE:

- Ideale per famiglie
- Catino integrato
- 1 entrata
- 2 abitacoli indipendenti
- Finestre Panorama
- Ottima ventilazione
- Porta anteriore alzabile a veranda
- Ottimo rapporto spazio/superficie
- Pali verticali inclusi

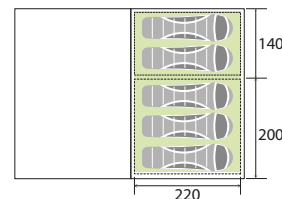
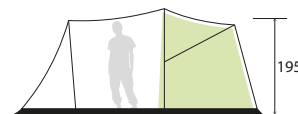
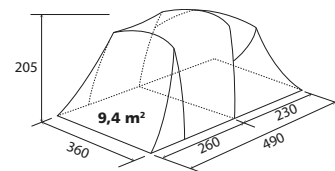



ARQUS

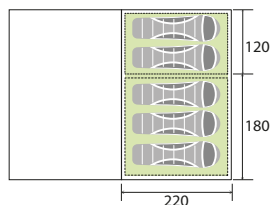
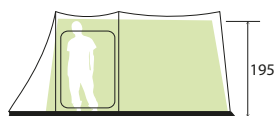
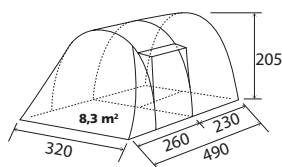

Tenda a tunnel che con il suo ampio allestimento offre tanta sicurezza e comfort al campeggiatore Outdoor.

CARATTERISTICHE:

- Montaggio veloce
- Leggera
- 2 Ingressi
- Catino cucito a chiusura totale
- Finestre Crystal tinte
- Palaria codificata a colori
- Cuciture nastrate
- Gancio per lampade
- Parete divisoria della cabina interna chiudibile mediante cerniera
- Sono inclusi picchetti in plastica, tiranti, sacca custodia e pali verticali

ARQUS OUTDOOR 5

Art. 0103057N

€ 574,90

Polyester PU 100% Polyester

Breathable Polyester

300 x 220 x H195 cm

PE

Fiberglass

External Poles

16,5 kg

78 x Ø 26 cm

3000 mm/s
 5x





STRATO 2

Art. 0103088N.C70

€ 64,90

STRATO



 Polyester PU 100% Polyester

 205 x 150 x H105 cm

 PE

 Fiberglass

 External Poles

 2,1 kg

 64 x Ø 14 cm



Tenda monotelo con apertura di ventilazione in sommità di cupola. Completa di accessori di montaggio e sacca custodia.

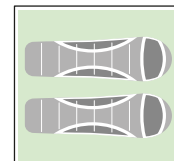
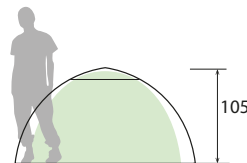
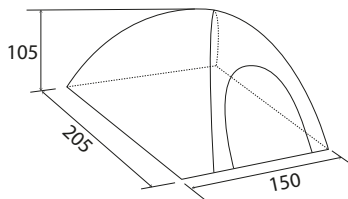

INFO

CONSIGLI PER L'UTILIZZO CORRETTO DELLA TENDA

Prima di partire per le vacanze in tenda effettuate sempre un montaggio di prova. In tal modo potrete arrivare a destinazione conoscendo già la procedura di montaggio e contemporaneamente verificare che tutto sia a posto. Applicate sempre le corde di controventatura badando a non esagerare con la tensione. In caso di forte vento sostituite i picchetti in dotazione con picchetti antibufera. Su terreni particolarmente duri o rocciosi è consigliato l'uso di appositi spilloni. Alcune condizioni meteorologiche favoriscono la formazione di condensa all'interno della tenda. Per minimizzare questo processo naturale evitate di appendere biancheria o abbigliamento bagnato nella tenda, aumentate il livello di ventilazione interna e utilizzate un telo di protezione salvacatino. Prima di riporre la tenda provvedete a togliere possibili residui di sporco mediante una morbida spugnetta bagnata con semplice acqua. Evitate di lavare la tenda con la lavatrice o mediante l'utilizzo di prodotti chimici. Controllate che la tenda sia completamente asciutta prima di ripiegarla per evitare formazione di muffa o cattivi odori. Infine è consigliabile portare sempre con sé un kit riparazione che includa pali ed elastici di ricambio, toppe adesive per la riparazione di eventuali strappi, cordini antibufera e qualche picchetto di riserva.











GLOBO 3

Art. 0103083N

€ 239,90

GLOBO



-  68D Polyester PU/Alu 100% Polyester
-  Breathable Polyester
-  210 x 205 x H125 cm
-  PE
-  Fiberglass
-  External Poles
-  5 kg
-  56 x Ø 21 cm

2000
 3x

La tenda a cupola è l'ideale compagno di viaggio grazie al peso leggero, al montaggio facile e veloce ed allo spazio sufficiente per il bagaglio. Sono inclusi picchetti in plastica, tiranti, sacca custodia.

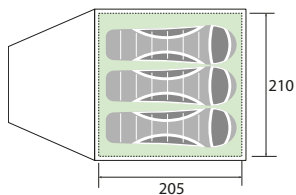
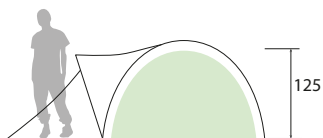
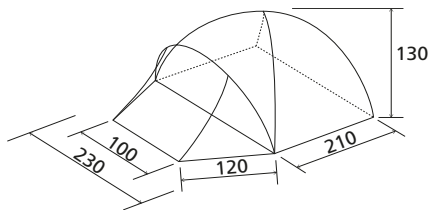



STRATO 2 AUTOMATIC

Tenda a cupola automatica per 2 persone. Montata e pronta all'uso in pochissimi secondi grazie allo speciale sistema di tensionamento a cavi integrati. Monotelo con grande porta chiudibile a cerniera. Completa di sacca custodia ed accessori di montaggio.

CARATTERISTICHE:

- Costruzione monotelo
- 2 aperture di ventilazione laterali
- Abitacolo con zanzariera
- Tasca interna
- Aste automatiche in fibra di vetro Ø 8,5 mm con trazione a fune
- Catino in materiale PE impermeabile

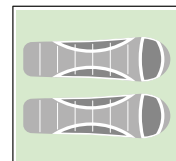
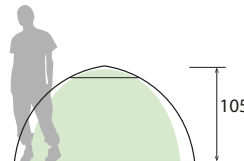
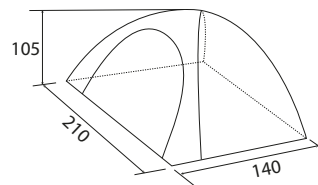

STRATO 2 AUTOMATIC

Art. 0102978N

€ 114,90

100% Polyester

Fiberglass / Automatic

210 x 140 x H105 cm

2,3 kg

62 x Ø 15 cm

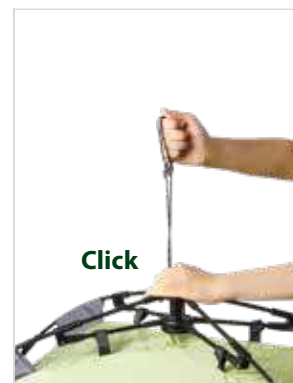



BLITZ 3 AUTOMATIC

Tenda automatica a cupola con doppio tetto e comoda abside. Grazie alla moderna struttura con tecnologia di trazione a fune integrata, può essere montata e pronta all'uso in pochi secondi. Corde premontate. Dimensioni compatte e peso ridotto. Con borsa per il trasporto.

CARATTERISTICHE:

- Costruzione a doppio tetto con abside
- Ingresso anteriore protetto dalle intemperie
- 1 ventilazione nella zona del tetto con copertura
- 2 aperture di ventilazione laterali
- Abitacolo con zanzariera e copertura
- Tasca interna
- Aste automatiche in fibra di vetro Ø 8,5 mm con trazione a fune
- Catino in materiale PE impermeabile

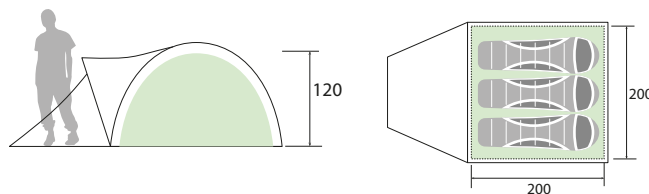
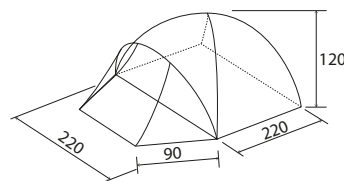

BLITZ 3 AUTOMATIC

Art. 0102980N

€ 169,90

 100% Polyester

 200 x 200 x 120 cm

 Fiberglass / Automatic

 310 x 220 x 120 cm

 3,8 kg

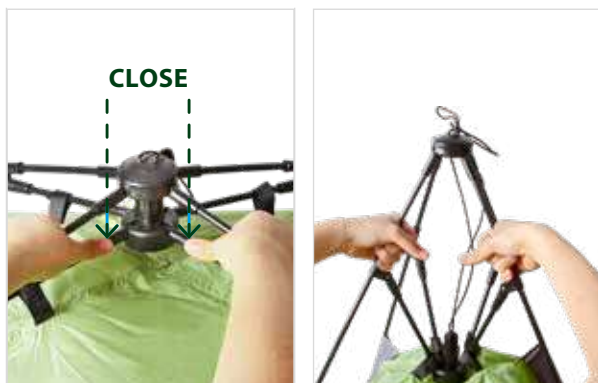
 76 x Ø 16 cm



DRIVE-AWAY AWNINGS

60/40
Polycotton

100%
Polyester



INNOVAZIONE PER UN FUTURO PIÙ CONFORTEVOLE

Viaggiare in minibus significa libertà e flessibilità, ma richiede una certa autosufficienza e la possibilità di allestire rapidamente un accampamento mobile. Sia che preferiate fare un breve week-end con gli amici o coccolare la vostra famiglia con una settimana di vacanza rilassante, la nostra collezione di verande minibus con telaio ad aria è la soluzione ideale se desiderate un po' più comfort, spazio e un montaggio semplice e senza problemi. Godetevi una vacanza da sogno senza stress ed arrabbiature. La collezione di verande minibus Brunner continuerà a crescere e sarà ampliata da numerosi e interessanti nuovi modelli. Gli sforzi per un funzionamento ottimale, l'alta qualità e l'ulteriore sviluppo del livello di comfort rimangono invariati:

- La creazione di spazio aggiuntivo per vivere, dormire e ripostiglio
- Utilizzo alternativo come zona cottura per mantenere i fastidiosi odori fuori dall'abitacolo del veicolo
- La possibilità di prenotare la tua piazzola preferita anche in caso di assenza

Le tende ad aria Brunner A.I.R.Tech sono disponibili per diverse altezze di montaggio.

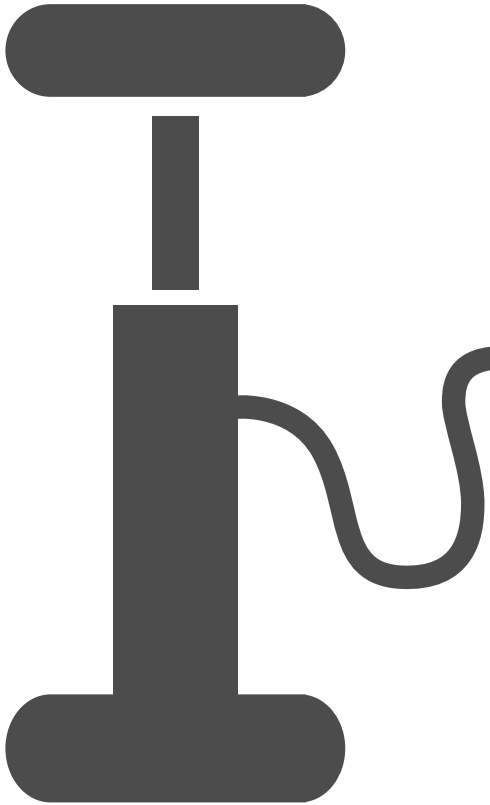

QUICK MOUNTING



INFO

Tutti i modelli di tende e verande Brunner con la denominazione Polycotton sono realizzate con uno speciale tessuto dalle eccellenti proprietà outdoor. Si tratta di un materiale non spalmato che si sigilla naturalmente con un contenuto di cotone del 40%, ma senza rinunciare alle proprietà positive del tessuto in poliestere (contenuto 60%).

CIÒ COMPORTA I SEGUENTI VANTAGGI:

- Traspirante, quindi sensibile miglioramento del clima interno della tenda/veranda
- Significativa riduzione della formazione di acqua di condensazione
- Significativamente più resistente ai raggi UV rispetto alle tende in poliestere comparabili
- Maggiore longevità operativa





AIR TRAVEL II

La Air Travel II, di nuova concezione, è dotata di una struttura ad aria A.I.R. Tech di alta qualità con sistema di gonfiaggio Oneflate. Tutti gli elementi in tessuto sono realizzati in robusto policotone Pure Pro, che conferisce alla tenda un clima interno molto piacevole e una scarsa formazione di condensa. L'elevata resistenza ai raggi UV garantisce una durata estremamente lunga della tenda.

CARATTERISTICHE:

- Struttura pneumatica A.I.R. Tech altamente stabile e indipendente
- Sistema di gonfiaggio ad una sola camera (struttura ad aria monocamera)
- Ampio ingresso anteriore, che può essere allestito come tettoia parasole (2 pali inclusi), completamente rimovibile, finestre colorate con oscuramento
- Ingresso laterale a destra, configurabile come tettuccio parasole
- Portellone con porta separata a destra
- Parete posteriore completamente rimovibile, apribile a metà, utilizzabile come veranda (frangivento)
- Grandi finestre laterali oscurate con zanzariera e oscuranti
- Piccole finestre oscurate nel soggiorno, con oscuranti
- Stuoia veranda
- Balza perimetrale esterna
- Tensionamento della tenda mediante robuste cinghie
- La tenda può essere montata con elastici a scaletta in PVC sostituibili
- Accesso ai cavi con serratura nella parete posteriore
- Ganci ed elementi in velcro per il fissaggio delle lampade
- Include una pompa d'aria di alta qualità con valvola di sicurezza
- Borsa extra large con cinghie di compressione
- Cabina interna ordinabile come optional
- Per veicoli con altezza grondaia di 170 - 210 cm

OPZIONI DI COLLEGAMENTO AL VEICOLO:

- Con profilo keder 5/7 mm
- Con palo di collegamento
- Cinghie di fissaggio con clip per le barre del tetto
- Corde per il fissaggio passando sul tetto





Enjoy
THE
EXPERIENCE

AIR TRAVEL II

Art. 0102956N

€ 1199,90

 Polycotton

 PE

 370 x 320 x H210 cm

 AIRTUBE

 28,5 kg

 80 x Ø 30 cm

<M>
mountless



Double
Connection
5/7

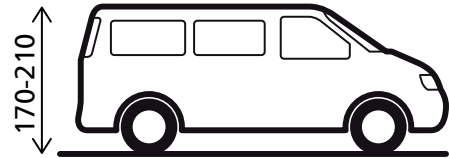
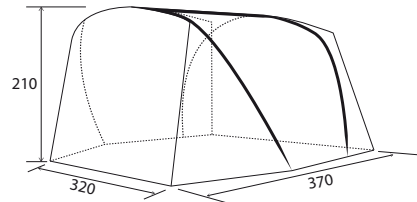

a.i.r.
tech
air inflation raising





a.i.r.
tech
air inflation raising

60/40
Polycotton

ADVANTOURER

L'Advantourer è la tenda ideale per il vostro van. Grazie al suo telo esterno in polycotone le sue prestazioni in termini di traspirabilità e resistenza ai raggi UV sono di gran lunga superiori rispetto alle tradizionali tende in poliestere.

CARATTERISTICHE:

- Struttura A.I.R. Tech, indipendente
- Catino cucito
- Tunnel di collegamento con porta d'accesso laterale
- Verandino frontale con laterali per la protezione dal sole e dalla pioggia
- Soggiorno con finestre con zanzariera (con oscuranti)
- Porta d'ingresso ampia e con zanzariera, con un'apertura variabile - parziale o completa
- Grande ingresso laterale
- Pali verticali inclusi

Adatta per veicoli con altezza grondaia da: 180 - 240 cm

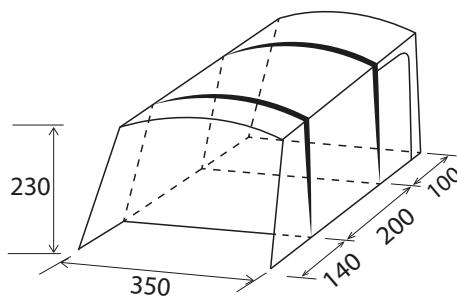









ADVANTOURER

Art. 0102970N

€ 1199,00

-  Polycotton
-  Breathable Polycotton
-  PE
-  (140+200+100) x 350 x H230 cm
-  AIRTUBE
-  32,1 kg
-  80 x Ø 41 cm



Attenzione!
Non adatta per campeggio
stanziale/stagionale

<M>
mountless





RHOMBUS VAN

Bellissimo tendalino parasole per minibus e van. Pronto all'utilizzo in pochissimi minuti grazie alla sua solida struttura pneumatica. Realizzato interamente in tessuto Pure Pro ad alta resistenza UV. Utilizzando le pareti laterali (disponibili come optional), è possibile ottenere un ampio spazio di soggiorno protetto dal vento, dalle intemperie e dagli sguardi indiscreti.

CARATTERISTICHE:

- Struttura pneumatica A.I.R.Tech altamente stabile
- Sistema di gonfiaggio mono-camera ad aria Oneflate
- Numerosi punti di ancoraggio
- Montaggio semplice e veloce

Una pompa d'aria di alta qualità con valvola di sicurezza é inclusa.

Fornita con: picchetti, corde di ancoraggio e grande borsa per il trasporto

OPZIONI DI COLLEGAMENTO AL VEICOLO:

- Con doppio profilo di collegamento

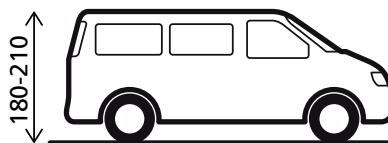

RHOMBUS VAN

Art. 0102957N

€ 639,90

Polycotton

AIRTUBE

260 x 200 x H210 cm

66 x Ø 24 cm

11,2 kg



a.i.r.
tech
air inflation raising

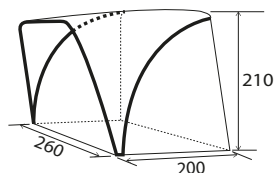

OPTIONAL

RHOMBUS VAN SIDEWALL SET

Art. 0102943N

€ 179,90

Polycotton

Set 3 pareti per tendalino parasole Rhombus Van.
Montaggio semplice e veloce.



SKIA 300/400



I tendalini parasole SKIA rappresentano il naturale sviluppo della tecnologia A.I.R.Tech e consentono di completarne l'inserimento, il gonfiaggio e l'ancoraggio in pochissimi minuti ed in assoluta comodità. Decade contemporaneamente la necessità di utilizzare i tradizionali pali in metallo o in fibra di vetro. Utilizzando le pareti laterali (disponibili come optional), è inoltre possibile ottenere un ampio spazio di soggiorno protetto dal vento, dalle intemperie e dagli sguardi indiscreti.

Lo SKIA è semplicissimo da montare grazie alla sua struttura pneumatica composta da un palo di sostegno anteriore ed ad un palo di stabilizzazione del tetto. Il collegamento al mezzo avviene mediante un profilo di scorrimento precucito. Dal design moderno ed accattivante, questo tendalino parasole è prodotto utilizzando il speciale tessuto Pure Pro, un policotone con spalmatura PU che garantisce un'ottima resistenza ai raggi UV, un'ottima traspirabilità ed una lunga durata di utilizzo. Tutte le cuciture sono nastrate per garantire l'impermeabilità dell'ambiente interno. La fornitura comprende una pompa per il gonfiaggio della struttura, gli accessori di montaggio (picchetti e corde tensione) ed una pratica borsa per il trasporto. Disponibile in varie misure ed altezze di collegamento.

CARATTERISTICHE:

- Montaggio facile e veloce
- Con palo tetto pneumatico
- Connessione mediante profilo di scorrimento
- Include la pompa d'aria, la borsa ed il materiale di montaggio

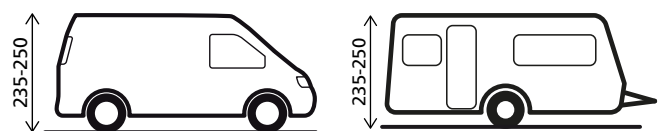

SKIA 300

Art. 0102931N

€ 541,90

▲ Polycotton

✘ AIRTUBE

✎ 300 x 250 x H250 cm

📏 70 x Ø 28 cm

📦 13,5 kg

SKIA 400

Art. 0102932N

€ 602,90

▲ Polycotton

✘ AIRTUBE

✎ 400 x 250 x H250 cm

📏 70 x Ø 30 cm

📦 15,5 kg

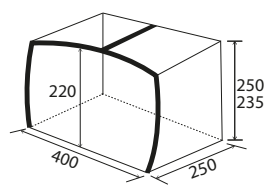
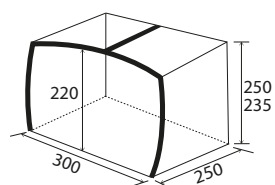

OPTIONAL

SKIA SIDEWALL SET

Art. 0102933N

€ 137,90

✘ Polycotton

Set 2 pareti laterali per tendalino parasole Skia (adatto per entrambe le misure del tendalino). Montaggio semplice e veloce.



TRAILS LC/HC

Tenda indipendente per Minibus con struttura pneumatica A.I.R. Tech a 2 archi. Accesso diretto al mezzo mediante entrata aggiuntiva nel tunnel di collegamento.

CARATTERISTICHE:

- Tutte le finestre sono oscurabili
- 2 entrate (1 anteriore - 1 laterale) con zanzariera
- Tettuccio frontale di protezione
- Ampio tunnel di collegamento
- 1 porta d'accesso attraverso il tunnel di collegamento
- Parete posteriore apribile completamente
- 2 aperture di ventilazione permanente
- Porta ingresso cavi elettrici con sistema portacavo
- Catino cucito a copertura totale
- Numerosi ancoraggi antibufera
- Ottima stabilità
- Con accessori di montaggio e sacca custodia
- Pali verticali inclusi

COLLEGAMENTO AL VEICOLO MEDIANTE:

- Profilo di scorrimento
- Asta di collegamento
- Nastri per corrimano con chiusura a contatto

Adatta per veicoli con altezza grondaia da 180 a 220 cm (TRAILS LC) / 245 a 280 cm (TRAILS HC).

Accessori di serie: palo di collegamento, corde tensione, picchetti, sacca custodia, pompa doppia azione.

<M>
mountless

a.i.r.
tech
air inflation raising





TRAILS LC

Art. 0102984N

€ 766,50

Polyester Oxford PU 100% Polyester

PE

AIRTUBE

320 x (220+100) x H180/220 cm

18 kg

80 x Ø 33 cm

Double Connection 5/7

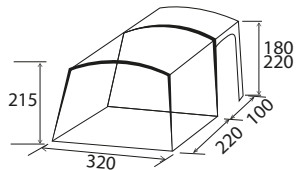

TRAILS HC

Art. 0102975N

€ 818,50

Polyester Oxford PU 100% Polyester

PE

AIRTUBE

320 x (220+100) x H215 cm

18 kg

80 x Ø 33 cm

Double Connection 5/7

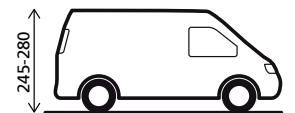
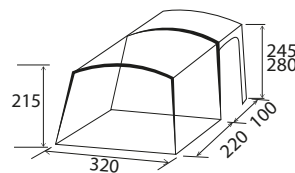



a.i.r. tech
air inflation raising

TROUPER 2.0

100% Polyester
Oxford

La nuova versione 2.0 della prestigiosa veranda per minibus Troupier, si presenta con una nuova struttura pneumatica, che ottimizza lo sfruttamento dello spazio a parità di superficie occupata. Tutte le altre caratteristiche esclusive della collezione di tende per minibus A.I.R. Tech rimangono invariate. Con un tunnel di collegamento che copre un'altezza da 180 a 230 cm, la Troupier 2.0 è adatta anche per l'uso su minibus di medie dimensioni.

CARATTERISTICHE:

- Spaziosa tenda per minivan
- Costruzione indipendente
- Costruita con tecnologia Crossbeam
- Porte d'ingresso con zanzariera
- Pompa a doppia azione inclusa
- Catino cucito perimetralmente
- Grandi finestre Panorama
- Ventilazione supplementare nel tetto
- Numerosi punti di controventatura

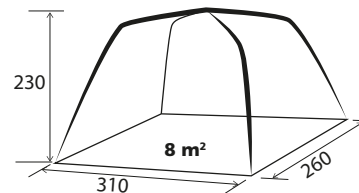

COLLEGAMENTO AL VEICOLO MEDIANTE:

- Profilo di scorrimento
- Asta di collegamento
- Nastri per corrimano con chiusura a contatto

Adatta per veicoli con altezza grondaia da 180 a 230 cm

Accessori di serie: telo tenda con catino, paleria, palo di collegamento, corde tensione, picchetti, sacca custodia



Attenzione!
Non adatta per campeggio stanziale/stagionale

OPTIONAL



TROUPER CABIN

Art. 0102989N

€ 64,50

140 x 220 x H155 cm

100% Polyester

Camera interna per tenda Troupier 2.0/XL, fornibile come optional.

TROUPER 2.0

Art. 0102995N

€ 879,00

150D Oxford Polyester PU (100% Polyester)

AIRTUBE

310 x 260 x H230 cm

20,5 kg

80 x Ø 35 cm





a.i.r.
tech
air inflation raising

TROUPER XL

100% Polyester
Oxford

Tenda pneumatica per minibus sviluppata sulla base del modello A.I.R. Tech Trouper.

CARATTERISTICHE:

- Spaziosa tenda per minibus con grande abside anteriore
- Struttura pneumatica A.I.R. Tech con sistema di gonfiaggio Oneflate
- Costruzione indipendente
- Tecnologia Crossbeam
- Con pompa a mano con valvola di sovrappressione
- Catino cucito a copertura totale
- Porte d'ingresso con zanzariera
- Ampie finestre panoramiche
- Ventilazione aggiuntiva sul tetto
- Sopratelo con ingresso cavi
- Numerosi punti di controventatura
- Pali verticali inclusi
- Abitacolo opzionale

POSSIBILITÀ DI COLLEGAMENTO AL VEICOLO:

- Mediante profilo di scorrimento
- Mediante palo di collegamento
- Al corrimano mediante nastri con chiusura a contatto

Altezza di collegamento (grondaia del veicolo): 180-230 cm

Fornitura: telo esterno con catino, palo di collegamento, corde tensione, picchetti, sacca custodia

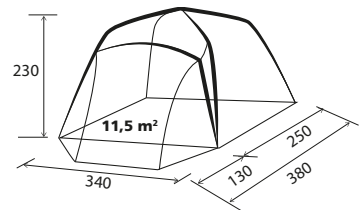

Attenzione!
Non adatta per campeggio
stanziale/stagionale

TROUPER XL

Art. 0102977N

€ 959,90



▲ 150D Oxford Polyester PU (100% Polyester)

▲ AIRTUBE / Fiberglass

▲ (130+250) x 340 x H230 cm

▲ 23,4 kg

▲ 82 x Ø 38 cm

3000 mm
▲ oneflate



a.i.r
tech
air inflation raising

100%
Polyester
Oxford

ALICE

Alice è una veranda altamente innovativa dotata di struttura pneumatica A.I.R. Tech a valvola singola. Offre la massima comodità a tutti coloro che necessitano di spazio supplementare per la loro caravan.

CARATTERISTICHE:

- Struttura pneumatica A.I.R. Tech
- Montaggio e smontaggio semplici e veloci
- Tubi pneumatici a 3 strati
- Con tendalino parasole
- Grandi entrate laterali con pannelli di ventilazione
- Con pompa doppia azione
- Una pratica borsa per il trasporto e gli accessori di montaggio sono inclusi nella fornitura

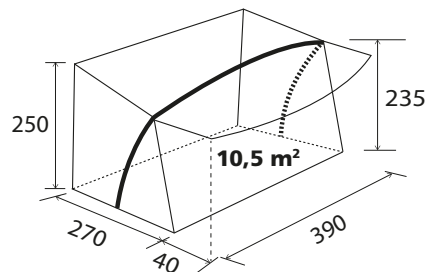

ALICE

Art. 0102991N

€ 999,00

300D Polyester Oxford 100% Polyester

AIRTUBE

390 x 270 x H235/250 cm

22 kg

85 x Ø 35 cm



Double
Connection
5/7

<M>
mountless



Attenzione!
Non adatta per campeggio
stanziale/stagionale





a.i.r.
tech
air inflation raising

100%
Polyester
Oxford

SKIA CAMPERVAN

Tendalino parasole con telaio gonfiabile (tecnologia A.I.R. Tech) per minibus e furgoni. Pronto all'uso in pochi secondi. Montaggio semplice grazie alla pompa dell'aria fornita di serie. I tubi pneumatici flessibili prevengono possibili danni al veicolo anche in caso di forte vento. Con predisposizione per il fissaggio di pareti laterali opzionali. Sono inclusi gli accessori di montaggio.

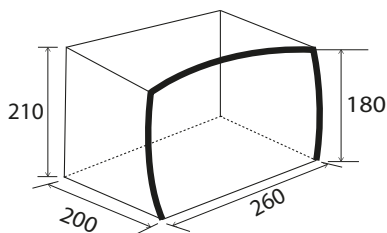

SKIA CAMPERVAN

Art. 0103005N

€ 344,50

 AIRTUBE

 260 x 200 x H180/210 cm

 150D Oxford Polyester PU (100% Polyester)

 65 x Ø 20 cm

 11 kg

 Double Connection 5/7

<M>
mountless



Attenzione!
Non adatta per campeggio
stanziale/stagionale



OPTIONAL

SKIA CAMPERVAN SIDEWALLS

Art. 0102964N

€ 89,90

 150D Polyester

Set di due pareti laterali.



BEYOND



Veranda indipendente con un eccellente rapporto qualità/prezzo.

POSSIBILITÀ DI COLLEGAMENTO AL VEICOLO:

- Mediante profilo di scorrimento
- Mediante palo di collegamento
- Al corrimano mediante nastri con chiusura a contatto
- Mediante adattatore speciale per profilo (optional)

Altezza di collegamento (grondaia del veicolo): 180-220 cm

Accessori di serie: telo esterno, paleria, asta aprichiusa, corde di tensione, picchetti, sacca custodia

Fornibile come optional: stuoia Trip 250x350 cm - 0201243N.C20

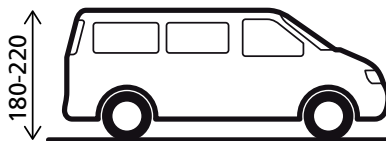
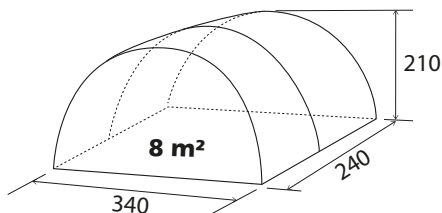

BEYOND

Art. 0103029N

€ 429,90

68D Polyester PU 100% Polyester

Durawrap Fiberglass 12,7 mm

External Poles

240 x 340 x H210 cm

12 kg

75 x Ø 25 cm



Attenzione!
Non adatta per campeggio
stanziale/stagionale

OPTIONAL

BEYOND CABIN

Art. 0103071N

€ 63,50

140 x 220 x H175 cm

Camera interna (abitacolo) per tenda Beyond.





RAMBLER



Spaziosa tenda per van e minibus di concezione moderna. Ottima ventilazione. Struttura collaudata e indipendente che permette di usufruire del mezzo per eventuali escursioni senza smontare la tenda.

CARATTERISTICHE:

- 4 grandi finestre oscurabili
- 1 finestra con zanzariera di ventilazione
- 2 entrate
- Parete posteriore apribile completamente
- 2 aperture di ventilazione permanente
- Porta ingresso cavi elettrici con sistema portacavo
- Porta laterale alzabile a tendalino
- Catino cucito a copertura totale
- Numerosi ancoraggi antibufera
- Asola portalamпада centrale

COLLEGAMENTO AL VEICOLO MEDIANTE:

- Profilo di scorrimento
- Asta di collegamento
- Nastri per corrimano con chiusura a contatto

Adatta per veicoli con altezza grondaia: 180-220 cm

Accessori di serie: telo tenda con catino, paleria, pali verticali, palo di collegamento, corde tensione, picchetti, sacca custodia.

RAMBLER

Art. 0103019N

€ 565,50



100% Polyester



Fiberglass



External Poles



350 x 260 x H220 cm



12,8 kg



74 x Ø 24 cm

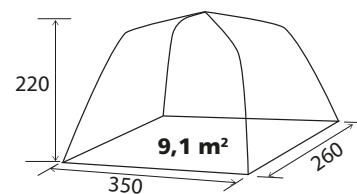

Attenzione!
Non adatta per campeggio
stanziale/stagionale





**BEST
SELLER**



**100%
Polyester**

ENTRADA

ENTRADA

Art. 0103006N

€ 396,90

 Polyester PU 100% Polyester

 Fiberglass

 External Poles

 310 x 270 x H210 cm

 10,5 kg

 74 x Ø 24 cm

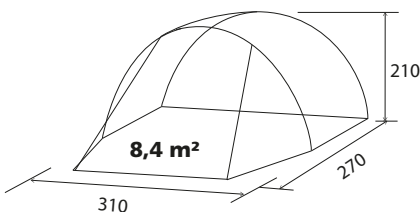

Tenda per van indipendente di dimensioni compatte, adatta per il collegamento a veicoli con un'altezza grondaia di 180-220 cm.

CARATTERISTICHE:

- Montaggio semplice e veloce mediante classici pali in fibra di vetro
- Rapporto ottimale tra spazio e superficie grazie alla forma a tunnel
- Balza perimetrale
- Porte frontali e laterali alzabili a tettuccio parasole (con pali opzionali)
- Ottimo sistema di controventatura
- Ampia finestra trasparente
- Pratico ingresso laterale
- Aperture di ventilazione integrate

Collegamento al veicolo mediante:

- Profilo di scorrimento
- Asta di collegamento
- Nastri per corrimano con chiusura a contatto

La dotazione comprende: telo esterno, asta aprichiusa, corde di tensione, picchetti, sacca custodia.



Attenzione!
Non adatta per campeggio
stanziale/stagionale

**MIX &
MATCH**



BULA
P. 180



SPECTRACOOL 25
P. 328



ALBATROS

ALBATROS

Art. 0103052N

€ 584,90

 Pigment Polyester PU (100 % Polyester)

 Fiberglass

 External Poles

 340 x (100+240) x H210 cm

 15,1 kg

 70 x 25 x 25 cm

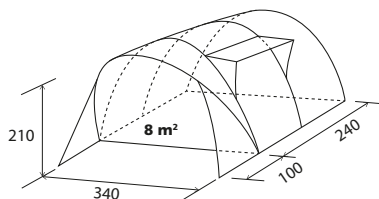

Attenzione!
Non adatta per campeggio
stanziale/stagionale

Tenda per Minibus moderna e indipendente.

CARATTERISTICHE:

- Parete anteriore removibile
- Entrata laterale con tettuccio
- Completa di balza perimetrale
- Con catino
- Ottima aerazione interna
- Tutte le finestre con copertura
- Parete posteriore chiudibile

POSSIBILITÀ DI FISSAGGIO AL MEZZO:

- Mediante profilo di scorrimento
 - Mediante palo di collegamento
 - Al corrimano mediante nastri con chiusura a contatto
 - Mediante adattatore speciale per profilo (optional)
- Altezza fissaggio (grondaia del veicolo):** 180-220 cm
Accessori di serie: telo, catino, paleria, palo di fissaggio, tiranti, picchetti, sacca custodia.



OPTIONAL

ALBATROS CABIN

Art. 0103053N

€ 69,90

 140 x 220 x H175 cm

Camera interna (abitacolo) per tenda Albatros.



OPTIONAL

MAGNETIC ADAPTER SET

Art. 7401016N

€ 50,90

 3 m

L'adattatore magnetico rappresenta un sistema semplice e pratico per collegarsi a veicoli sprovvisti di canalina. Aderisce perfettamente ai tetti piatti in lamiera di acciaio.



100%
Polyester
Oxford

PILOTE CADDY 4

PILOTE CADDY 4

Art. 0102967N

€ 149,50

 150D Oxford Polyester

 135 x 135 x H170/200 cm

 2,5 kg

 50 x Ø 12 cm



Attenzione!
Non adatta per campeggio
stanziale/stagionale

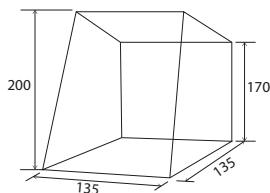

NEW
2023

PILOTE CADDY 5

Nuova tenda posteriore, senza telaio, ulteriormente sviluppata, applicabile al portellone posteriore del VW Caddy 5. Con questa tenda, molto ben accessoriata, l'abitacolo del Caddy si arricchisce di un comodo spazio per pranzare o per riporre i propri oggetti. La tenda viene fissata al portellone posteriore del veicolo con robuste cinghie. Le parti laterali sono fissate al veicolo con strisce magnetiche per renderle impermeabili alla pioggia. Nella zona inferiore, la Pilote Caddy 5 è legata saldamente al veicolo. La balza perimetrale esterna consente il deflusso di grandi quantità d'acqua. La parete anteriore può essere arrotolata o eretta come tettuccio parasole. Le due grandi finestre in zanzariera sul lato destro della tenda e sulla parete anteriore consentono un ottimo flusso d'aria. Le corde e i numerosi tiranti conferiscono alla tenda un elevato grado di stabilità.

CARATTERISTICHE:

- Tenda senza telaio con elevata stabilità al vento
- Robuste cinghie per il fissaggio al portellone posteriore
- Le pareti laterali possono essere fissate al veicolo, ben tese nella parte inferiore
- Parete anteriore completamente arrotolabile, con ampia finestra a rete (richiudibile con pellicola Crystal colorata, oscuramento interno)
- La parete anteriore può essere alzata a tettuccio parasole, con 2 pali inclusi
- Parete laterale destra con grande finestra in zanzariera, dotazione come nella parete anteriore
- Parete laterale sinistra con finestra fumé, oscuramento interno
- Balza perimetrale con occhielli
- Elastici a scaletta intercambiabili
- Picchetti in plastica da 30 cm
- Incl. borsa per il trasporto

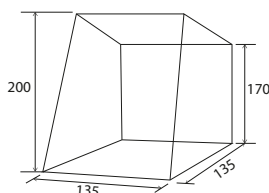

PILOTE CADDY 5

Art. 0102944N

€ 149,90

150D Oxford Polyester

135 x 135 x H200 cm

2,5 kg

50 x Ø 12 cm



Attenzione!
Non adatta per campeggio
stanziale/stagionale



100%
Polyester
Oxford

COMET

COMET

Art. 0102968N

€ 214,90

 150D Oxford Polyester PU

 200 x 200 x H205 cm

 5,1 kg

 63 x 18 cm



BRUNNER 

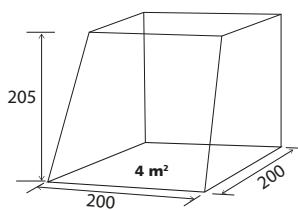

Attenzione!
Non adatta per campeggio
stanziale/stagionale





ESCAPE

La tenda per portellone posteriore Escape, di nuova concezione, si adatta a diversi modelli di veicoli con struttura identica: Peugeot Traveller, Citroën Spacetourer e Toyota Proace. L'installazione è un gioco da ragazzi. Il tetto della tenda viene semplicemente posizionato sul portellone posteriore e poi fissato con strisce magnetiche e cinghie. Le pareti laterali sono fissate con strisce magnetiche incorporate. Nella zona inferiore, il sopratelo della tenda è teso con numerosi elastici a scaletta sostituibili. Questa tecnica consente il montaggio senza attrezzi in pochi minuti. L'ampia parete anteriore può essere completamente arrotolata o essere alzata come tettuccio parasole. Una grande finestra in zanzariera è cucita su questa parete e può essere chiusa con una pellicola Crystal colorata, con oscuramento all'interno. Entrambe le finestre laterali sono realizzate con pellicola Crystal oscurante. La balza perimetrale esterna protegge dall'acqua piovana. Le stabili corde di ancoraggio e i numerosi tiranti rendono la tenda molto stabile al vento.

CARATTERISTICHE:

- Tenda senza telaio con elevata stabilità al vento
- Lunga durata grazie al poliestere Oxford 150D
- Robuste cinghie per il fissaggio al portellone posteriore
- Le pareti laterali possono essere fissate al veicolo, ben tese nella parte inferiore
- Parete anteriore completamente arrotolabile, con ampia finestra in zanzariera (richiudibile con pellicola Crystal colorata, oscuramento interno)
- La parete anteriore può essere alzata a tettuccio parasole, con 2 pali di sostegno inclusi
- Pareti laterali destra e sinistra con finestra oscurata, oscuramento interno
- Balza perimetrale con occhielli
- Elastici a scaletta sostituibili
- Picchetti in plastica da 30 cm
- Ampia borsa di trasporto con cinghie di compressione
- Il portabiciclette può rimanere montato sul portellone posteriore

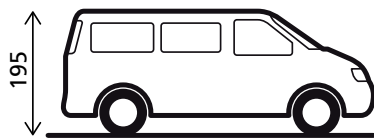
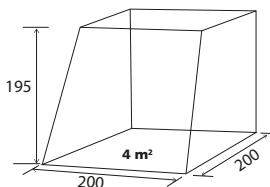

Attenzione!
Non adatta per campeggio
stanziale/stagionale

ESCAPE

Art. 0102945N

€ 216,50

	150D Oxford Polyester
	200 x 200 x H195 cm
	4,5 kg
	63 x 18 cm



DEFLECTOR

Comodi tendalini parasole realizzati in materiale sintetico resistente ai raggi UV. Lati bordati e occhiellati. Facili da montare sui profili di scorrimento di caravan, camper, furgonati o minibus. Adatto alle verande Fiamma, Thule e Omnistor.

DEFLECTOR QDR

Art. 0113065N

€ 119,90

360 x 360 cm

100% PE

2,5 kg

DEFLECTOR TRG

Art. 0113063N

€ 82,90

360 x 360 x 360 cm

100% PE

1 kg

FIXING KIT SYSTEM INCLUDED

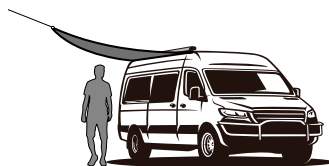
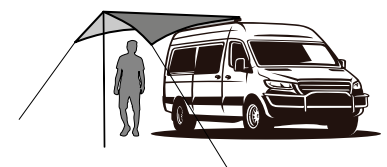
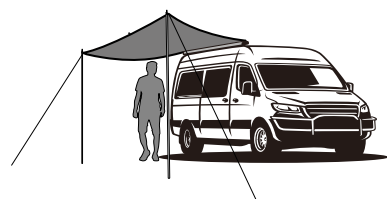

OPTIONAL

VERTICAL POLES

Art. 0103004N

€ 18,50

195 x Ø 1,6 cm

PCS. 2X

Pali verticali per tende.



PTHALATE free





SUNNY VIEW



Comodi tendalini parasole realizzati in materiale sintetico resistente ai raggi UV. Lati bordati e occhiellati. Facili da montare sui profili di scorrimento di caravan, camper, furgonati o minibus. Adatto alle verande Fiamma, Thule e Omnistor. Picchetti e cordini sono inclusi nella fornitura.



Art. 0106040N	290 x H190 cm	1,2 kg	€ 72,50
Art. 0106041N	340 x H190 cm	1,4 kg	€ 88,50
Art. 0106042N	390 x H190 cm	1,53 kg	€ 99,50
Art. 0106039N	240 x H190 cm	1 kg	€ 67,50
Art. 0106043N	440 x H190 cm	1,7 kg	€ 103,50



Double Connection 5/7

FIXING KIT SYSTEM INCLUDED



100-230 cm



SET TELEPOLE

Art. 0305036N

€ 67,90

100 - 230 cm

PACK 2X

Pali verticali telescopici in alluminio anodizzato a tre elementi Ø 31/26/21 mm. Con puntale e base.



OPTIONAL

VERTICAL POLES

Art. 0103004N

€ 18,50

195 x Ø 1,6 cm

PCS. 2X

Pali verticali per tende.





VANSHELL

VANSHELL 260

Art. 0106036N

€ 178,90

 260 x 240 cm

 Fiberglass

 68D 190T PU / Silver 2000 mm

 6 kg

VANSHELL 300

Art. 0106037N

€ 197,90

 300 x 240 cm

 Fiberglass

 68D 190T PU / Silver 2000 mm

 6,5 kg

Tendalino parasole per minibus e furgoni con telaio in fibra di vetro, piastra stabilizzatrice centrale e Keder di collegamento per il collegamento al profilo di scorrimento del veicolo. Costruzione molto stabile con leggera curvatura per un ottimale deflusso dell'acqua. Sono compresi 2 pali verticali. Come optional è disponibile un set di pareti laterali adatto ad entrambe le misure.





OPTIONAL

VANSHELL SIDEWALL SET

Art. 0106038N

€ 96,50

 240 cm

 68D 190T PU

Set pareti laterali (2 pz.) per tendalino parasole Vanshell. Il set è adatto per entrambe le misure del tendalino. Montaggio semplice e veloce.

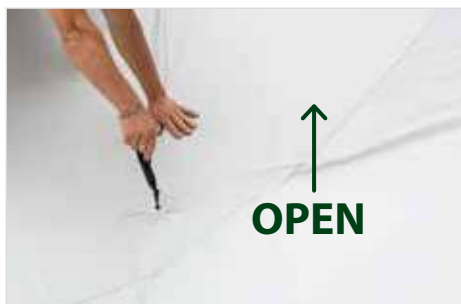





CARASHADE



CARASHADE

 300D Polyester PU

 Steel Ø 22/19 mm

 280 x 200 cm

Classico telo ombra per caravan con profilo di scorrimento. Completo di pali.

Art. 7130237N	280 x 200 cm	€ 141,50
Art. 7130238N	340 x 200 cm	€ 154,90
Art. 7130239N	400 x 200 cm	€ 165,90
Art. 7130189N	200 x 240 cm	€ 127,50
Art. 7130190N	250 x 240 cm	€ 139,90
Art. 7130191N	300 x 240 cm	€ 152,50
Art. 7130192N	350 x 240 cm	€ 163,90
Art. 7130193N	400 x 240 cm	€ 178,50
Art. 7130194N	450 x 240 cm	€ 191,50
Art. 7130246N	260 x 250 cm	€ 152,50
Art. 7130240N	380 x 260 cm	€ 181,90
Art. 7130241N	420 x 260 cm	€ 195,50





COMPLEMENTS



QEDER ADAPTER SET



Art. 7401019N	Ø 5 mm x 3 m	€ 51,50
Art. 7401020N	Ø 7 mm x 3 m	€ 49,50



Kit per collegare la tenda minibus al veicolo.



MAGNETIC ADAPTER SET

Art. 7401016N

€ 50,90



3 m

L'adattatore magnetico rappresenta un sistema semplice e pratico per collegarsi a veicoli sprovvisti di canalina. Aderisce perfettamente ai tetti piatti in lamiera di acciaio.



WHISPER ALU

Art. 0436002N

€ 42,90

- 1x 3000 CC
- 10 x 22 x 54 cm
- 1,2 kg

Pompa aria con pistone in alluminio e set adattatori.



CAPTURE

Art. 0102988N

€ 41,50

Ø 5,4 cm
120 g

Ventosa per tenda per minibus con corpo in metallo. Set 2 pz.

ATACO

Art. 0102985N

€ 24,90

Ø 11,5 cm
2x 238 g

Set di ventose con anello a D per il fissaggio senza viti di tendalini parasole, tende per minibus, teloni e molto altro ancora su superfici lisce. Possono essere caricate fino a max 12 kg. Set 2 pz.

FLAPLOCK

Art. 0301314N

€ 20,90

120 x 45 mm
95 g

Morsetto stabilizzante per tende e verande. Riduce fortemente l'eventualità di danni al tessuto in caso di forte vento. Corpo in materiale plastico. Set 2 pz.

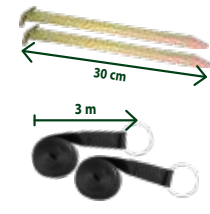

STABILIZER KIT

Art. 0301311N

€ 25,50

1,2 kg

Cinghia stabilizzante per verande camper e caravan in caso di vento. Il kit comprende: 1 nastro stabilizzatore (13 m) con molla di tensione e grandi picchetti di ancoraggio.

STABILIZER KIT UNIVERSAL

Art. 0301315N

€ 27,90

1,2 kg

Kit cinghie stabilizzanti per verande caravan. Adatto per la maggior parte delle verande di produzione europea con fibbie premontate. Il set comprende 2 robusti picchetti di ancoraggio, 2 molle di scarico tensione e 2 cinghie di sicurezza.

PROP

Art. 0301312N

€ 39,90

1,2 kg

Sistema stabilizzante per verande e tendalini parasole. Il set è dotato di 2 fibbie (2x 50cm+3m) e 2 picchetti robusti (2x 30cm). Pratica sacca custodia inclusa.



UN CUCINOTTO PER TUTTE LE OCCASIONI



I cucinotti hanno principalmente la funzione di una cucina mobile. Offrono anche numerosi vantaggi aggiuntivi che rendono il campeggio più facile e sono particolarmente apprezzati dalle famiglie:





- Più spazio e libertà di movimento nella veranda
- Nessun odore di cucina sgradevole nella veranda
- Ottima ventilazione
- Confortevole altezza interna
- Può essere usato anche come tenda Storage (si consiglia con catino)
- Perfetto per riporre in sicurezza biciclette, moto, grill o giocattoli per bambini
- Alcuni modelli sono disponibili con catino integrato o integrabile (vedi descrizione del prodotto)

Per coloro che apprezzano l'ordine e l'organizzazione consigliamo sempre l'utilizzo di un cucinetto o di una tenda Storage. La nostra gamma comprende una varietà di modelli e dimensioni progettati per diverse applicazioni. Leggere attentamente le descrizioni dei prodotti corrispondenti per selezionare il modello più adatto alle proprie esigenze.

**CHEF II OUTDOOR**

Art. 0426041N

€ 319,90

-  Polyester UV resistant 100% Polyester
-  200 x 200 x H190/230 cm
-  Fiberglass / Steel
-  11,6 kg
-  76 x Ø 23 cm

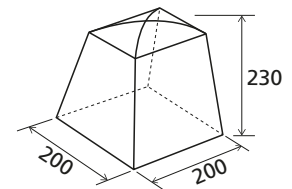



**Cucinotto moderno realizzato con materiali leggeri.****CARATTERISTICHE:**

- 3 finestre a zanzariera con copertura
- Entrata apribile a veranda
- Aerazione in sommità di cupola
- Balza perimetrale
- Completo di sacca custodia, pali verticali e accessori di montaggio

**DINERY**

Art. 0425994N

€ 391,50

-  Polyester PU 100% Polyester
-  240 x 240 x H190/230 cm
-  Fiberglass / Steel
-  16,7 kg
-  80 x Ø 28 cm

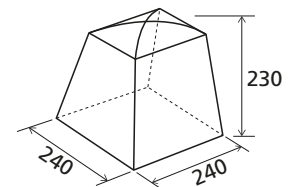

Tenda multiuso per cucina ed attrezzatura con un robusto telaio in acciaio/fibra di vetro, grandi finestre e una porta d'ingresso ad avvolgimento. Con balza perimetrale. Sono inclusi il materiale di montaggio e la sacca custodia.



TITANIUM AXIA
P. 190



CRUISER
P. 173



MERCURY CROSS
COOKER
P. 209

**MIX &
MATCH**



VIDA

Cucinotto con classico tetto a falde.

CARATTERISTICHE:

- Porta d'entrata arrotolabile lateralmente
- 3 grandi finestre a zanzariera con copertura
- Apertura di aerazione
- Con balza rialzata
- Completo di sacca custodia e accessori di montaggio



VIDA I NG

Art. 0425998N.C30

€ 259,90

PVC / Polyester / Oxford

200 x 150 x H195/215 cm

Steel Ø 19 mm

13,5 kg

100 x 21 x 26 cm

VIDA II NG

Art. 0425999N.C30

€ 289,90

PVC / Polyester / Oxford

200 x 200 x H195/215 cm

Steel Ø 19 mm

16,5 kg

100 x 21 x 26 cm

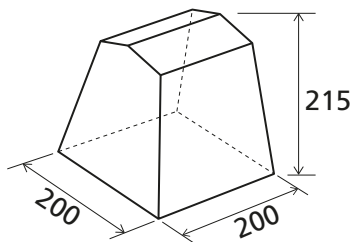
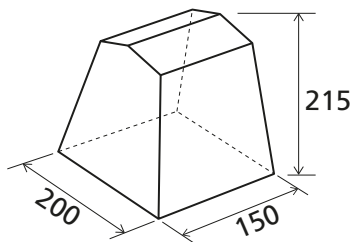



GUSTO

Cucinotto con classico tetto a falde.

CARATTERISTICHE:

- Finestre a zanzariera con copertura
- Balza perimetrale
- Con porta ingrandita e finestre supplementari entrata luce
- Completo di sacca custodia e accessori di montaggio



GUSTO I NG

Art. 0425995N

€ 286,90

PVC / Polyester / Oxford PVC

150 x 150 x H195/215 cm

Steel Ø 19 mm

11,7 kg

100 x 21 x 25 cm

COLORS

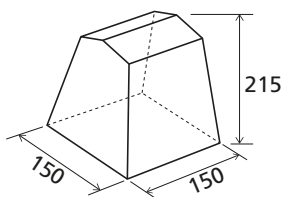

GUSTO II NG

Art. 0425996N

€ 299,90

PVC / Polyester / Oxford PVC

200 x 150 x H195/215 cm

Steel Ø 19 mm

13,5 kg

100 x 21 x 26 cm

COLORS

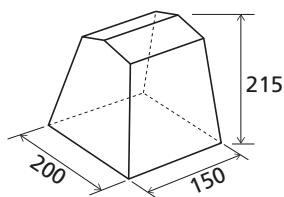

GUSTO III NG

Art. 0425997N

€ 345,50

PVC / Polyester / Oxford PVC

200 x 200 x H195/215 cm

Steel Ø 19 mm

16,5 kg

100 x 21 x 26 cm

COLORS

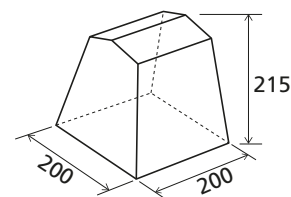



CAMP INN

Moderno cucinotto multiuso. Design innovativo con tetto arcuato in poliesteresalmato su entrambi i lati (PVC).

CARATTERISTICHE:

- Pareti laterali e posteriori con grandi finestre di ventilazione in zanzariera con telo di copertura
- Parete anteriore con porta arrotolabile lateralmente
- Apertura di ventilazione permanente
- Con balza perimetrale
- Completo di sacca custodia e accessori di montaggio

CAMP INN

Art. 0426013N

€ 479,90

PVC / Polyester / Oxford PVC

220 x 160 x H195/220 cm

Steel Ø 22 mm

19,5 kg

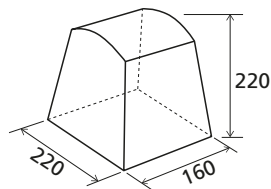

MIX & MATCH



SPECTRACOOOL 25
P. 328



VINIS FOLD-AWAY
p. 308



SKIPPER
p. 284



MIDDAY DEEP SEA
p. 246



CORIANDER

Tenda multifunzione di nuova concezione. Funge perfettamente da tenda cucina e da ripostiglio per la protezione di tutte le attrezzature che non possono essere lasciate all'aperto. L'intera tenda è realizzata in PVC ed è sostenuta da un robusto telaio in acciaio. Tre grandi finestre con zanzariera e un'efficiente ventilazione del tetto garantiscono un'ottima aerazione. Con ampia porta d'ingresso arrotolabile lateralmente. Con balza perimetrale. Incl. accessori e sacca custodia.

CORIANDER I

Art. 0425991N.C06

€ 439,90



PVC



200 x 150 x H195/210 cm



Steel Ø 22 mm



20,5 kg

CORIANDER II

Art. 0425992N.C06

€ 471,50



PVC



200 x 200 x H195/210 cm



Steel Ø 22 mm



23 kg

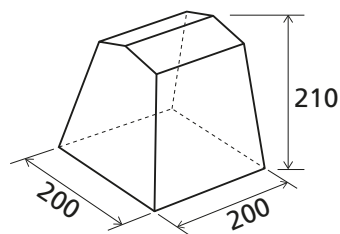
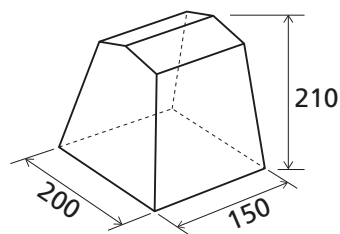



CABINA

Pratica tenda cabina per campeggio e spiaggia. Ideale per la doccia e cambiarsi, ma anche come tenda cucina.

CARATTERISTICHE:

- Porta con cerniera
- Grande finestra posteriore
- Balza perimetrale
- Con sacca custodia ed accessori di montaggio

CABINA II NG

Art. 0102028N

€ 112,50

 Polyester UV resistant 100% Polyester

 140 x 140 x H205 cm

 Fiberglass

 2,65 kg

 67 x Ø 23 cm

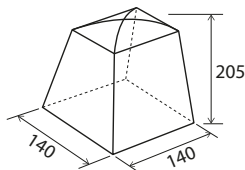

CABINA MAXI NG

Art. 0102029N

€ 131,90

 Polyester UV resistant 100% Polyester

 180 x 160 x H205 cm

 Fiberglass

 4 kg

 70 x Ø 27 cm

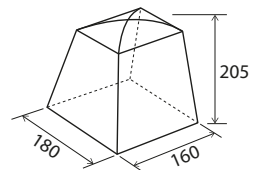



SANITY

Tenda sanitaria versatile e polivalente con pali stabili in acciaio, pavimento rimovibile e finestra di zanzariera richiudibile. Sono comprese varie soluzioni funzionali ed una pratica borsa da trasporto.

SANITY

Art. 0102025N

€ 144,90

 68D Polyester PU (100% Polyester)

 140 x 140 x H205 cm

 Steel Ø 16 mm

 6 kg

 80 x 41 cm

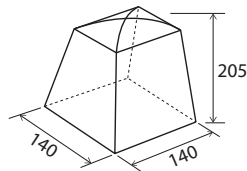

STORAGE PLUS

Pratica tenda per attrezzi con tetto a 2 falde, ideale per il campeggiatore ben accessoriato. Robusta, con catino saldamente cucito. L'ampia porta d'ingresso sul lato anteriore può essere comodamente aperta tramite due cerniere e, se necessario, essere aperta come tettuccio parasole. La parete posteriore è dotata di un'ampia finestra a zanzariera che può essere chiusa mediante una pellicola in Crystal. 3 aperture di ventilazione sulla parete anteriore e laterali garantiscono una sufficiente circolazione dell'aria all'interno della tenda. Materiale di montaggio incluso.

STORAGE PLUS

Art. 0426044N.C06

€ 339,90

 PVC / Oxford Polyester

 225 x 160 x H175/195 cm

 Steel Ø 19 mm

 13,9 kg

 94,5 x 22 x 28 cm

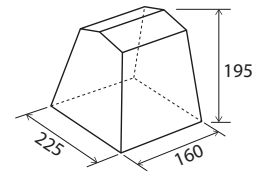

Info p. 346

ON-OFF DIMMER
0-100%



Energy class
in process of approval



220V



12V



Energy class
in process of approval









12V



220V

OPTIONAL

								
AMBEL COMPACT	Art. 7530026N	50 x 2 x 1,5 cm	125 g	12V DC - 220V AC	500 lumen	30	7W	€ 52,90
AMBELL	Art. 7530027N	120,5 x 2,8 x 2,4 cm	468 g	12V DC - 220V AC	1100 lumen	180	12W	€ 78,50

La versione compatta della lampada Ambel L.

Lampada tubolare LED per verande e gazebo. Montaggio ai pali della struttura mediante clips in plastica Ø 22-26 mm.



a.i.r.
tech
air inflation raising

100%
Polyester
190T

AQUAMAR

Gazebo outdoor gonfiabile realizzato con tecnologia Crossbeam.

CARATTERISTICHE:

- Semplice e rapido da montare e smontare
- Aste di stabilizzazione sui 4 lati
- Altezza interna 2 metri
- Pompa a doppia azione inclusa
- Sacca custodia inclusa
- Accessori di montaggio inclusi
- Set pareti laterali (2 pz.) disponibile come optional

AQUAMAR

Art. 0102004N.C70

€ 494,50

 190T Polyester 75D Polyester PU

 AIRTUBE

 300 x 300 x H190/220 cm

 13,6 kg

 75 x Ø 29 cm



OPTIONAL

AQUAMAR SIDEWALL SET

Art. 0102015N.C70

€ 46,50

 100% Polyester

Set di due pareti laterali per gazebo Aquamar.



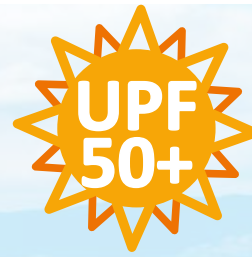





PROTEZIONE DAL SOLE

È arrivata l'ora del divertimento al sole ed all'aria aperta. Divertimento da affrontare sempre in sicurezza e ben protetti dai potenzialmente pericolosi raggi UV. Sia che vi stiate godendo una giornata di sole in giardino o a bordo piscina o sulla spiaggia, i prodotti per la protezione dal sole Brunner sono gli accessori giusti da usare. Progettati per essere leggeri e facilmente trasportabili, quasi tutti vantano un fattore di protezione UV 50+ ideale per mantenere la pelle fresca e ben protetta. Brunner è da sempre sinonimo di design funzionale ed innovazione creativa. Tutti i prodotti vengono sviluppati e realizzati con la passione per una vita da trascorrere all'aria aperta. Il nostro obiettivo è sempre quello di offrire attrezzatura di elevata qualità che combini il meglio della convenienza, della funzionalità e del design, per fornire una protezione efficace dal sole, dal vento o dalla pioggia.



BRUNNER



-  Polyester PU 100% Polyester
-  Steel Ø 19 mm
-  320 x 320 x H180/215 cm
-  12,1 kg
-  105 x Ø 17 cm

DIADEM

Art. 0102005N.C06 € 287,50

Gazebo Outdoor con struttura in acciaio. Ottima protezione dal sole.



OPTIONAL





DIADEM SIDEWALL SET

Art. 0102001N.C06 € 59,90

-  100% Polyester

Set di due pareti laterali per gazebo Diadem.



-  190T 68D PU / Silver PU2000 mm
-  Fiberglass
-  300 x 300 x H220 cm
-  9,2 kg
-  78 x Ø 18 cm

OCEANA

Art. 0102013N € 258,90

L'Oceana è un gazebo outdoor di nuova concezione, di grande impatto visivo e di ottima stabilità. È ideale per qualsiasi incontro di gruppo, dal minibus camping, al soggiorno in spiaggia, al barbecue in giardino. La speciale forma del tetto protegge dal sole e dalla pioggia anche tutta l'attrezzatura. L'Oceana viene fornito con tutto il necessario per il suo utilizzo: pali in fibra di vetro, picchetti, corde tensione ed una sacca custodia. Sono incluse 2 pareti laterali. La stuoia per il pavimento è opzionale.



OPTIONAL

OCEANA SIDEWALL SET

Art. 0102014N € 46,50

-  300 x 300 cm

Set di pareti laterali (2 pz.) per gazebo outdoor Oceana. Con borsa per il trasporto.



MEDUSA II

INFO

IL FATTORE DI PROTEZIONE UV

Il fattore di protezione indica il livello di protezione UV dei vari tessuti. Esistono numerose similitudini con il sistema SPF che indica il livello di protezione di creme solari. Tessuti con un fattore di protezione UV 50+ permettono il passaggio di appena 1/50 della radiazione. Ciò significa che il 98% dei raggi UV viene bloccato.

MEDUSA II 3X3

Art. 0102034N

€ 269,90

 68D Polyester PU 100% Polyester

 Fiberglass / Steel

 300 x 300 x H190/230 cm

 10 kg

 62 x Ø 23 cm

COLORS



Gazebo per outdoor con paleria esterna in acciaio e fibra di vetro. Completo di due pareti laterali staccabili.



OPTIONAL

MEDUSA SIDEWALL SET 300

Art. 0102057N

€ 49,50

 100% Polyester

 300 x H178 cm

Set di due pareti laterali per gazebo Medusa.



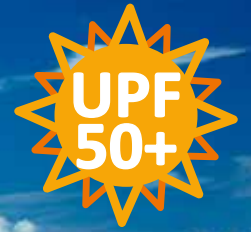

100% Polyester
68D Polyester PU

MEDUSA II 4X4

Art. 0102030N

€ 374,50

 68D Polyester PU 100% Polyester

 Fiberglass / Steel

 400 x 400 x H190/230 cm

 12,2 kg

 69 x Ø 25 cm

COLORS



Gazebo Outdoor con paleria esterna in acciaio e fibra di vetro. Completo di due pareti laterali staccabili.





OPTIONAL

MEDUSA SIDEWALL SET 400

Art. 0102055N

€ 61,50

 100% Polyester

 400 x H178 cm

Set di due pareti laterali per gazebo Medusa.



3 SIDES WITH MESH

BAYOU

Art. 0113039N

€ 83,50



100% Polyester

PE

Fiberglass

245 x 150 x H100 cm

1,2 kg

2 x Ø 75 cm



Conchiglia parasole con sistema Pop Up. Offre spazio sufficiente per 2 persone. Gli accessori di montaggio sono inclusi.



UMBRA

Art. 0113040N

€ 67,50

100% Polyester

PE

Fiberglass

200 x 150 x H130 cm

1,9 kg

59 x Ø 12 cm



Moderna conchiglia parasole con spazio per 2-3 persone. Con accessori di montaggio e sacca custodia.



TONGA

TONGA

Art. 0113016N

€ 37,50

100% Polyester

PE

Fiberglass

240 x 110 x H155 cm

1,35 kg

53 x Ø 9 cm



Conchiglia parasole che protegge da vento, sabbia e sguardi indiscreti. Catino fissato mediante cucitura. Sacca custodia inclusa.



PAGODA

Art. 0102023N.C30 € 195,90

- 68D Polyester PU/Alu 100% Polyester
- Fiberglass
- 300 x 300 x H195 cm
- 4,3 kg
- 61 x Ø 15 cm

Stabile gazebo parasole con paleria in fibra di vetro. Protegge da sole, pioggia e vento. Sono incluse due pareti laterali.



OPTIONAL

PAGODA SIDEWALL SET

Art. 0102024N € 41,50

- 100% Polyester

Set di due pareti laterali per il gazebo parasole Pagoda. Fissaggio delle pareti tramite velcro.

SUNTOP

Art. 0113049N € 69,90

- 100% Polyester
- Fiberglass
- 250/150 x 190 x H150 cm
- 1,68 kg
- 63 x Ø 12 cm



Conchiglia parasole di grandi dimensioni.

CARATTERISTICHE:

- Unisce i vantaggi di una conchiglia parasole con quelli di un ombrellone
- Le pareti laterali rialzate garantiscono una buona ventilazione
- Montaggio e smontaggio semplici e rapidi
- Con pratica borsa per il trasporto

SUNNY UV



Art. 0113055N	100% Polyester	Steel Ø 19 mm	2 x 3 m	1,84 kg	€ 65,90
Art. 0113056N	100% Polyester	Steel Ø 19 mm	3 x 3 m	2,02 kg	€ 81,50
Art. 0113057N	100% Polyester	Steel Ø 19 mm	3 x 4 m	2,30 kg	€ 96,50

Utilissima vela parasole con numerose varianti di montaggio. La fornitura comprende 2 pali verticali in acciaio.



BARRIER

Paravento ideale per l'uso in campeggio o in giardino. Stabile e di alta qualità, con quattro pali verticali e tre aste orizzontali di stabilizzazione in acciaio Ø 22 mm.

BARRIER 400

Art. 0113001N

€ 139,90

 H140 x 400 cm

 81 x 16 x 16 cm

 5,52 kg

 100% Polyester

BARRIER 600

Art. 0113002N

€ 158,50

 H140 x 600 cm

 81 x 16 x 16 cm

 6,6 kg

 100% Polyester



LAOLA

Paravento da spiaggia. Sono compresi picchetti, corde tensione ed una sacca custodia.

LAOLA

Art. 0113047N

€ 68,90

 H115 x 400/520 cm

 64 x Ø 11 cm

 1,6 kg

 100% Polyester





PANAMA

Telo paravento con finestrella panoramica in plastica trasparente.

PANAMA SKY 400

Art. 0113058N.C30

€ 72,50

	H140 x 400 cm
	84 x 20 cm
	2,5 kg
	100% PE

PANAMA SKY 600

Art. 0113059N.C30

€ 88,50

	H140 x 600 cm
	84 x 25 cm
	3,3 kg
	100% PE



BAHAMAMA

Paravento da spiaggia dai colori vivaci. Viene fornito con materiale di montaggio ed una pratica sacca custodia.

BAHAMAMA TNT

Art. 0113048N

€ 37,50

	H110 x 480 cm
	H118 x 18 cm
	1,1 kg
	TNT

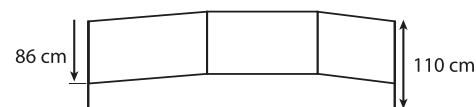



GAZEBOS & BEACH PARASOLS

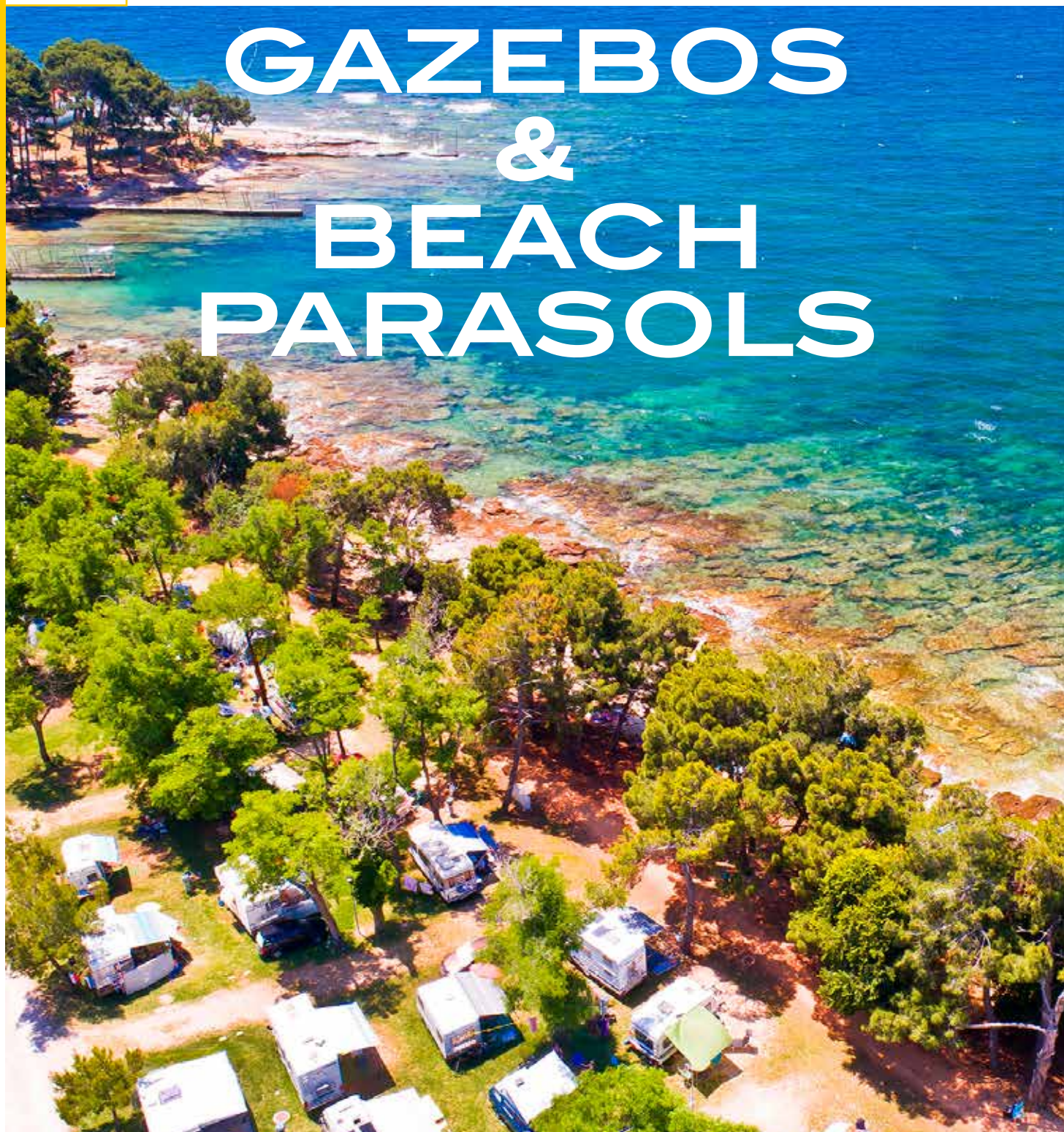

**GAZEBI AUTOMATICI
OMBRELLONI**

ZEBÒ COLLECTION

Gazebo pieghevoli Zebò per il tempo libero, per il camping, per gli eventi e per la vendita.

Da oltre 20 anni la nostra gamma di prodotti comprende gazebo pieghevoli di alta qualità per le più svariate attività. In questo lasso di tempo, il nostro team di sviluppo prodotto ha sempre cercato di migliorare i materiali e la relativa produzione. Tutti i materiali sono accuratamente selezionati e testati in condizioni reali per soddisfare le aspettative del cliente e garantire l'affidabilità e la durata desiderata.

I gazebo pieghevoli Zebò sono particolarmente apprezzati nel settore del tempo libero e del campeggio, ma sono anche ideali per eventi, presentazioni o feste. Sono facili e veloci da montare e smontare e possono essere riposti in modo

compatto e comodamente trasportati.

Importante: tutti i componenti sono avvitati insieme per facilitarne la manutenzione e possono quindi essere facilmente sostituiti.

La collezione di gazebo pieghevoli Zebò comprende i seguenti modelli:

- Zebò Enjoy 2.0 - Robusti gazebo pieghevoli con telaio in acciaio verniciato a polvere (profilo rettangolare 40x40 mm). Disponibile in 3 misure.

- Zebò Enjoy PRO - Gazebo PRO pieghevole in alluminio di alta qualità, con struttura a profilo esagonale da 50 mm. Disponibile in 3 misure.



COLLECTION	ZEBÒ ENJOY	ZEBÒ ENJOY	ZEBÒ ENJOY	ZEBÒ ENJOY	ZEBÒ ENJOY	ZEBÒ ENJOY
	2.0 3x3	2.0 3x4,5	2.0 3x6	PRO 3x3	PRO 3x4,5	PRO 3x6
Struttura pieghevole automatica	•	•	•	•	•	•
Struttura ad innesto	-	-	-	-	-	-
Struttura in acciaio	•	•	•	-	-	-
Struttura in alluminio	-	-	-	•	•	•
Palo tetto centrale	•	•	•	•	•	•
Struttura regolabile in altezza	•	•	•	•	•	•
Componenti struttura avvitati	•	•	•	•	•	•
Snodi rinforzati	•	•	•	•	•	•
Tessuto tetto in poliesteri	•	•	•	•	•	•
Tessuto tetto in PE	-	-	-	-	-	-
Cuciture nastrate	•	•	•	•	•	•
Punti di contatto tetto/struttura rinforzati	•	•	•	•	•	•
Spalmatura tetto in PVC	•	•	•	•	•	•
Varianti colore	1	1	1	1	1	1
Pareti laterali optional	•	•	•	•	•	•
Accessori di montaggio inclusi	•	•	•	•	•	•



ZEBÒ ENJOY 2.0



Snodi di alta qualità



Cinghia di fissaggio



Nastro premi e chiudi per fissaggio pareti



Gambe regolabili in altezza

Pratico gazebo automatico con palo centrale per una massima inclinazione del tetto che favorisce il deflusso dell'acqua. Stabile struttura in profili di acciaio verniciato a polvere con gambe regolabili in altezza. Tetto realizzato in 100% poliestere a spalmatura impermeabile. Cuciture nastrate. La fornitura comprende una pratica borsa per il trasporto munita di ruote. Sono inclusi tiranti e picchetti.

Montaggio e smontaggio semplice e rapido. Campi d'utilizzo: Camping, feste ed eventi, fiere.

CARATTERISTICHE:

- Tipo struttura: automatica-pieghevole
- Gambe: in acciaio verniciato a polvere 40x40 mm, regolabili in altezza
- Tutti i componenti sono avvitati e sostituibili

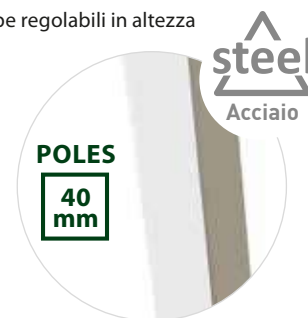





ZEBÒ ENJOY 2.0 3X3

Art. 0102211N.C00

€ 310,50

 3 x 3 x 2,10/3,35 m

 155 x 24 x 24 cm

 100% Polyester / PVC 290 g/m2

 40x40/35x35/15x30 mm

 25,5 kg





ZEBÒ ENJOY 2.0 3X4,5

Art. 0102212N.C00

€ 399,90

 3 x 4,5 x 2,10/3,35 m

 155 x 32 x 22 cm

 100% Polyester / PVC 290 g/m2

 40x40/35x35/15x30 mm

 32,2 kg





ZEBÒ ENJOY 2.0 3X6

Art. 0102213N.C00

€ 545,90

 3 x 6 x 2,10/3,35 m

 155 x 42 x 22 cm

 100% Polyester / PVC 290 g/m2

 40x40/35x35/15x30 mm

 43,7 kg





ZEBÒ ENJOY PRO



Snodi di alta qualità



Cinghia di fissaggio



Nastro premi e chiudi per fissaggio pareti



Gambe regolabili in altezza

Gazebo automatico semiprofessionale con struttura esagonale di alta qualità. Dotato di palo centrale per una massima inclinazione del tetto che favorisce il deflusso dell'acqua. Struttura molto stabile in alluminio con gambe regolabili in altezza. Tetto realizzato in 100% poliestere a spalmatura impermeabile. Cuciture nastrate. La fornitura comprende una pratica borsa per il trasporto munita di ruote. Sono inclusi tiranti e picchetti. Montaggio e smontaggio semplice e rapido. Campi d'utilizzo: Feste ed eventi, mercatini, fiere.

CARATTERISTICHE:

- Tipo struttura: automatica-pieghevole
- Gambe: in alluminio 50 mm, regolabili in altezza
- Spessore profili: gambe 2,0 mm - tetto 2,0 mm
- Tutti i componenti sono avvitati e sostituibili





ZEBÒ ENJOY PRO 3X3

Art. 0102221N.C00

€ 594,50

3 x 3 x 2,10/3,35 m

158 x 25 x 25 cm

100% Polyester / PVC 290 g/m2

50/45/32x16 mm

22,5 kg



ZEBÒ ENJOY PRO 3X4,5

Art. 0102222N.C00

€ 814,50

3 x 4,5 x 2,10/3,35 m

158 x 32 x 24 cm

100% Polyester / PVC 290 g/m2

50/45/32x16 mm

28,7 kg



ZEBÒ ENJOY PRO 3X6

Art. 0102223N.C00

€ 1026,50

3 x 6 x 2,10/3,35 m

158 x 42 x 24 cm

100% Polyester / PVC 290 g/m2

50/45/32x16 mm

38,2 kg



OPTIONAL

SIDEWALL SET ZEBÒ ENJOY 2.0 / PRO

Utilissimo set di pareti laterali per gazebo pieghevoli ZEBÒ ENJOY 2.0 e ENJOY PRO.

Le pareti laterali completano ogni gazebo pieghevole e lo rendono resistente alle intemperie e al vento. Tutte le pareti laterali vengono semplicemente fissate all'interno del bordo del gazebo tramite nastro premi e strappa già predisposto e collegabili mediante l'ausilio di cerniere. Nella fornitura è compresa una borsa custodia.

Art. 0102215N.C00

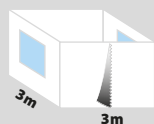

Art. 0102216N.C00

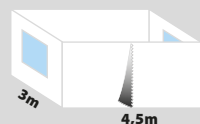

Art. 0102217N.C00

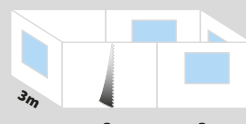

Art. 0102215N.C00 3 x 3 m 210 PU Polyester 8,5 kg € 182,90

Art. 0102216N.C00 3 x 4,5 m 210 PU Polyester 10,6 kg € 201,90

Art. 0102217N.C00 3 x 6 m 210 PU Polyester 12,8 kg € 251,50



BASE

Art. 0303064N

€ 34,50

Ø 25 cm

1,3 kg

COLORS



Base stabilizzante in materiale plastico. Per gazebo con gambe da Ø 25 a 32 mm. Viene fornita in coppia.



BALLAST NG

Art. 0303078N

€ 62,90

10 kg

Zavorra in ghisa per la stabilizzazione delle singole gambe dei gazebo. Con cinghia di fissaggio. Adatto per profili fino a 40x40 mm.



SOLADO

SOLADO

Art. 0113013N

€ 87,50

Moderno ombrellone da sole e da spiaggia di dimensioni compatte. Dotato di stelo in alluminio e di un robusto telo resistente ai raggi UV. I passanti aggiuntivi alle estremità dei raggi dell'ombrellone permettono l'ancoraggio contro il forte vento. Nella parte inferiore dell'ombrellone ci sono 2 ganci e una pratica rete per gli utensili. Grazie all'inclinazione laterale regolabile, questo ombrellone offre la migliore protezione solare in qualsiasi momento della giornata. Borsa per il trasporto inclusa.

 Ø 200 x H220 cm

 120 x 12 cm

 100% Polyester

 2,52 kg

 Aluminium

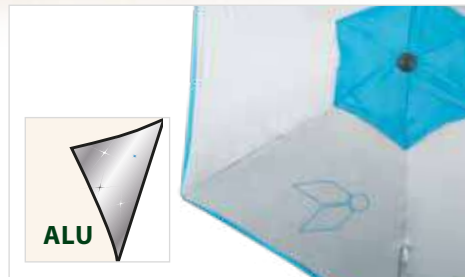

ALU



included

INFO

PROTEZIONE DAL SOLE

È arrivata l'ora del divertimento al sole ed all'aria aperta. Divertimento da affrontare sempre in sicurezza e ben protetti dai potenzialmente pericolosi raggi UV. Sia che vi stiate godendo una giornata di sole in giardino o a bordo piscina o sulla spiaggia, i prodotti per la protezione dal sole Brunner sono gli accessori giusti da usare. Progettati per essere leggeri e facilmente trasportabili, quasi tutti vantano un fattore di protezione UV 50+ ideale per mantenere la pelle fresca e ben protetta. Brunner è da

sempre sinonimo di design funzionale ed innovazione creativa. Tutti i prodotti vengono sviluppati e realizzati con la passione per una vita da trascorrere all'aria aperta. Il nostro obiettivo è sempre quello di offrire attrezzatura di elevata qualità che combini il meglio della convenienza, della funzionalità e del design, per fornire una protezione efficace dal sole, dal vento o dalla pioggia.

ONDA PARSOL

ONDA PARSOL

Art. 0113017N

€ 68,50

 205/200 x H220 cm

 123 x 13 cm

 Polyester 180g

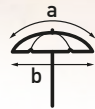
 2 kg

a: 205 cm
b: 200 cm



Moderno ombrellone realizzato in resistente tessuto sintetico e struttura molto stabile a 6 raggi. Stelo molto robusto in acciaio verniciato a polvere Ø 32 mm con snodo in alluminio e puntale a vite per terreni sabbiosi. Ottima resistenza al vento grazie al soffietto di scarico integrato. Con borsa per il trasporto.

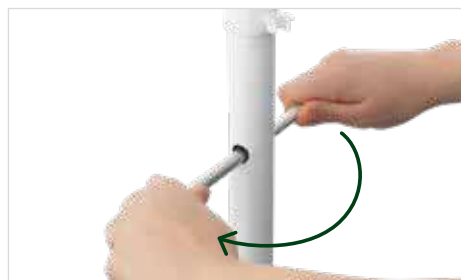

IL FATTORE DI PROTEZIONE UV

Il fattore di protezione indica il livello di protezione UV dei vari tessuti. Esistono numerose similitudini con il sistema SPF che indica il livello di protezione di creme solari. Tessuti con un fattore di protezione UV 50+ permettono il passaggio di appena 1/50 della radiazione. Ciò significa che il 98% dei raggi UV viene bloccato.



BEACH PARASOL

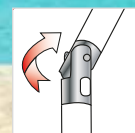

DOUBLE USE

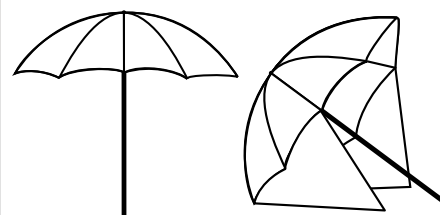

BEACH PARASOL

Art. 0113009N.C08

€ 47,90

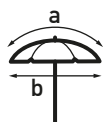

a: 155 cm
b: 140 cm

- Ø 140 x H140 cm
- 100% Polyester
- Alu / Fiberglass

BEACH PARASOL XL

Art. 0113010N.C08

€ 54,90

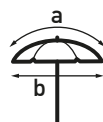

a: 195 cm
b: 175 cm

- Ø 175 x H160 cm
- 100% Polyester
- Alu / Fiberglass



Ombrellone predisposto per l'applicazione di pareti laterali che lo trasformano in una praticissima conchiglia parasole.

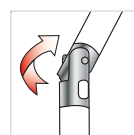

SUN PARASOL 180

Art. 0113025N

€ 51,50

- Ø 180/160 x H198 cm
- Ø 9 x H107 cm
- 100% PES
- 1,6 kg

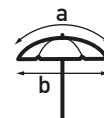

a: 180 cm
b: 160 cm

SUN PARASOL 200

Art. 0113026N

€ 59,50

- Ø 200/190 x H198 cm
- Ø 9 x H107 cm
- 100% PES
- 1,8 kg

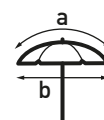

a: 200 cm
b: 180 cm



Ombrellone di alta qualità da giardino e spiaggia.









PARSOL RIDE2SEA 180

Art. 0113028N.C9N

€ 43,50

-  Ø 180/160 x H190 cm
-  64 x 20 x 7 cm
-  Polyester / Alu
-  1,48 kg
-  Steel Ø 25 mm

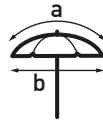

a: 180 cm
b: 160 cm

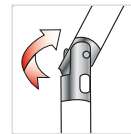

Ombrellone parasole supercompatto. Grazie al suo speciale sistema di montaggio non supera i 64 cm di lunghezza quando smontato.



RIO

Art. 0303043N

€ 4,90

 39 cm x Ø 13/33 mm

Picchetto portaombrelloni realizzato in robusto materiale plastico. Con adattatore per steli da 13 a 33 mm.



DRILLER

Art. 0303044N

€ 9,90

 32,5 cm x Ø 13/33 mm

Picchetto portaombrelloni avvitabile per terreni sabbiosi. Con manico e vite di fissaggio per l'ombrellone. Realizzato in resistente materiale plastico.



WAIKIKI BASIC

Art. 0303046N

€ 9,50

 45 cm Ø tube 36 mm

Picchetto portaombrelloni in acciaio zincato.



CAMPING ACCESSORIES



**PALERIA ED ACCESSORI TENDE
TELONI ED ACCESSORI**



PICCHETTI

La maggior parte delle tende in commercio viene offerta con picchetti standard. In modo che la vostra tenda si possa fissare adeguatamente su ogni tipo di suolo e con ogni condizione meteorologica è sempre consigliato adattare l'assortimento di picchetti.



PER TERRENI MISTI

TEMPEST



PACK

Art. 0303010C	20 cm	6X	€ 9,90
Art. 0303011C	25 cm	6X	€ 11,50
Art. 0303012C	30 cm	6X	€ 12,50

Picchetto in acciaio zincato.

THOR



PACK

Art. 0303028C	18 cm	5X	€ 11,50
Art. 0303029C	23 cm	5X	€ 14,50
Art. 0303030C	27 cm	5X	€ 13,50

Picchetto in acciaio zincato.

DRAGON



PACK

Art. 0303035C	20 cm	6X	€ 5,90
Art. 0303036C	25 cm	6X	€ 6,50
Art. 0303037C	30 cm	6X	€ 6,90

Picchetto speciale in ABS.



STAKE SET

Art. 0303033N

€ 23,50



Pratico set picchetti per camping e veicoli ricreazionali. Confezionato in contenitore di plastica.

IL SET CONTIENE:

- 20 robusti picchetti in plastica da 23 cm per terreni erbosi e sabbiosi
- 10 picchetti per stuoia da 8 cm
- Attrezzo levapicchetti con manico rivestito



PER TERRENI DURI



SQUARE

			PACK	
Art. 0302010C	22 cm x Ø 8 mm	4X	€ 7,90	
Art. 0302012C	30 cm x Ø 8 mm	4X	€ 8,90	

Picchetto speciale quadrato per terreni duri. Acciaio zincato.



STICK

			PACK	
Art. 0302017C	20 cm x Ø 6 mm	4X	€ 7,50	
Art. 0302018C	25 cm x Ø 6 mm	4X	€ 8,50	

Spillone chiodo, in acciaio zincato.



SQUARE TWISTED

			PACK	
Art. 0302014C	22 cm	4X	€ 9,90	
Art. 0302015C	30 cm	4X	€ 14,50	



I picchetti Twisted sono realizzati in alluminio e garantiscono una maggiore tenuta nel terreno grazie alla loro ritorcitura.



STICK PLUS

			PACK	
Art. 0303014C	23 cm x Ø 8 mm	4X	€ 11,50	
Art. 0303015C	25 cm x Ø 8 mm	4X	€ 13,90	



Spillone chiodo rotondo con gancio in plastica, in acciaio zincato.



QUADRA

			PACK	
Art. 0302003C	18 cm x 5x5 mm	6X	€ 7,50	

Spillone quadrato, in acciaio zincato.



HEXA

			PACK	
Art. 0303032C	22 cm x Ø 8 mm	4X	€ 8,50	
Art. 0303034C	30 cm x Ø 8 mm	4X	€ 9,50	

Picchetto speciale per terreni duri. Acciaio zincato.



LINE

			PACK	
Art. 0302019C	18 cm x Ø 5 mm	6X	€ 6,50	
Art. 0302020C	23 cm x Ø 5 mm	6X	€ 6,90	
Art. 0302021C	28 cm x Ø 5 mm	6X	€ 7,90	

Spillone rotondo, in acciaio zincato.

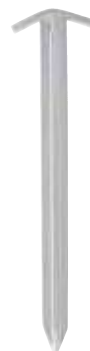

MATRIX

			PACK	
Art. 0303038C	30 cm	2X	€ 14,50	
Art. 0303039C	40 cm	2X	€ 16,50	
Art. 0303040C	50 cm	2X	€ 18,90	

Picchetto a T in acciaio zincato, molto robusto.



PER TERRENI MORBIDI E SABBIOSI



TURCAL

			PACK	
Art. 0303005C	22 cm	6X	€ 8,50	
Art. 0303003C	26 cm	6X	€ 9,90	



Picchetto in acciaio zincato.



SANDLOCK

			PACK	
Art. 0303023C	31 cm	2X	€ 14,50	

Picchetto in alluminio per terreni sabbiosi o innevati.



STABILIZER 38

			PACK	
Art. 0301313C	38 cm	2X	€ 9,90	

Picchetto in lamiera d'acciaio da 2 mm per terreni misti.

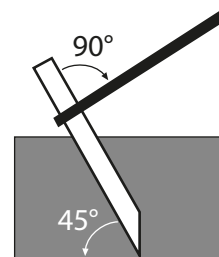

RIO

Art. 0303043N € 4,90

39 cm x Ø 13/33 mm



Picchetto portaombrelloni realizzato in robusto materiale plastico. Con adattatore per steli da 13 a 33 mm.



DRILLER

Art. 0303044N € 9,90

32,5 cm x Ø 13/33 mm



Picchetto portaombrelloni avvitabile per terreni sabbiosi. Con manico e vite di fissaggio per l'ombrellone. Realizzato in resistente materiale plastico.



WAIKIKI BASIC

Art. 0303046N € 9,50

45 cm Ø tube 36 mm



Picchetto portaombrelloni in acciaio zincato.



WINDBASE

Art. 0303056N € 13,50

35,5 x Ø 9,5 cm

PACK 1X

Supporto in acciaio zincato per pali paravento con diametro 25 mm. Rondella fissa.



ELIX

Art. 0303066N € 9,50

42 cm x Ø 8 mm

Picchetto di ancoraggio in acciaio zincato, con anello di fissaggio.

PER TERRENI DURI

PEG BOX



CLEAN SYSTEM



PEG BOX STICK 20

Art. 0303067N

€ 23,50

20 cm x Ø 6 mm

PACK 20X

26 x 8 x 17 cm

Spillone chiodo, in acciaio zincato.



PEG BOX STICK 25

Art. 0303068N

€ 25,50

25 cm x Ø 6 mm

PACK 20X

26 x 8 x 17 cm

Spillone chiodo, in acciaio zincato.



PEG BOX STICK PLUS 23

Art. 0303069N

€ 33,50

23 cm x Ø 8 mm

PACK 20X

26 x 8 x 17 cm

GLOW



Spillone chiodo rotondo con gancio in plastica, in acciaio zincato.



PEG BOX STICK PLUS 25

Art. 0303070N

€ 36,90

25 cm x Ø 8 mm

PACK 20X

26 x 8 x 17 cm

GLOW



Spillone chiodo rotondo con gancio in plastica, in acciaio zincato.



PEG BOX SQUARE 22

Art. 0303071N

€ 34,50

22 cm x Ø 8 mm

PACK 20X

26 x 8 x 17 cm

Picchetto speciale quadrato per terreni duri. Acciaio zincato.



PEG BOX HEXA 22

Art. 0303072N

€ 27,50

22 cm x Ø 8 mm

PACK 20X

26 x 8 x 17 cm

Picchetto speciale per terreni duri. Acciaio zincato.



COBRA



PACK

Art. 0204001C 6 cm x Ø 4 mm 6X € 5,50

Gancio ad S in acciaio zincato.

ANCHOR



PACK

Art. 0301048C 30 mm 10X € 6,90

Gancio ad ancora in alluminio.

SCREWBLOCK



PACK

Art. 0301059N 30 mm 4X € 9,50



Morsetto universale per funi e cavetti (non adatto per cavi elettrici).

RUNNER XL



PACK

Art. 0301061C Ø 4 mm 10X € 6,90



Grande tenditore in alluminio a 3 fori adatto per corde di tensione fino a 4 mm di diametro. Colore: rosso anodizzato. Indicato in particolare modo per tende di grandi dimensioni e/o gazebi.

RUNNER 2



PACK

Art. 0301063C Ø 5 mm 10X € 4,90



Tenditore per corda in alluminio a due fori.

RUNNER 3



PACK

Art. 0301064C Ø 4 mm 10X € 7,50

Art. 0301067C Ø 5 mm 10X € 7,50



Tenditore per corda in alluminio a tre fori.



CAPTURE

Art. 0102988N

€ 41,50

Ø 5,4 cm

120 g



Ventosa per tenda per minibus con corpo in metallo. Set 2 pz.



VANOOK

Art. 0102973N

€ 23,50

Ø 12 cm

2x 250 g

OPEN / CLOSE

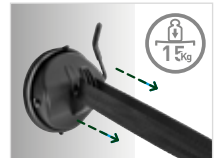
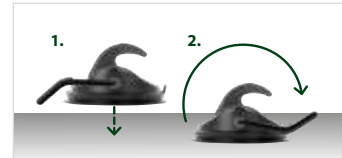

Set di ventose ad uncino per il fissaggio semplice, veloce e senza viti di tendalini, verande minibus e parasole. Basta posizionare la ventosa nella posizione desiderata sulla carrozzeria del veicolo ed azionare la levetta di bloccaggio. Ogni ventosa sopporta un carico di 15 kg. Set 2 pz.



ATACO

Art. 0102985N

€ 24,90

Ø 11,5 cm

2x 238 g



Set di ventose con anello a D per il fissaggio senza viti di tendalini parasole, tende per minibus, teloni e molto altro ancora su superfici lisce. Possono essere caricate fino a max 12 kg. Set 2 pz.



GORO



Art. 0301210N	Ø 3 mm x 20 m	€ 3,50
Art. 0301212N	Ø 4 mm x 15 m	€ 3,50

Cordino multiuso in poliestere intrecciato, su rocchetto.

POWER



Art. 0301220N.C00	Ø 3 mm x 20 m	€ 6,50
Art. 0301221N.C00	Ø 3 mm x 50 m	€ 13,50
Art. 0301202N.C00	Ø 4 mm x 20 m	€ 11,50
Art. 0301223N.C00	Ø 4 mm x 50 m	€ 12,90
Art. 0301222N.C00	Ø 5 mm x 20 m	€ 10,50
Art. 0301224N.C00	Ø 5 mm x 50 m	€ 20,90

Corda multiuso, in PP intrecciato.

SIGNAL



Art. 0301230N.C2M	Ø 3 mm x 20 m	€ 6,90
Art. 0301231N.C2M	Ø 3 mm x 50 m	€ 12,50

Corda multiuso con colorazione di sicurezza. In PP intrecciato.

STRIPER



PACK



Art. 0301250N.C00	Ø 3 mm x 3 m	4X	€ 9,90
Art. 0301251N.C00	Ø 3 mm x 4 m	4X	€ 11,50
Art. 0301252N.C00	Ø 4 mm x 3 m	4X	€ 11,50
Art. 0301253N.C00	Ø 4 mm x 4 m	4X	€ 12,50

Corda tensione in PP con tenditore a tre fori.

NOLAN



PACK



Art. 0301271N.C00	Ø 4 mm x 3 m	4X	€ 8,50
Art. 0301272N.C00	Ø 4 mm x 4 m	4X	€ 9,50
Art. 0301273N.C00	Ø 3 mm x 2 m	4X	€ 7,50
Art. 0301274N.C00	Ø 3 mm x 3 m	4X	€ 7,50
Art. 0301275N.C00	Ø 3 mm x 4 m	4X	€ 8,50

Corda tensione in PP con tenditore a due fori ed anello.



STABILIZER KIT

Art. 0301311N € 25,50

1,2 kg

Cinghia stabilizzante per verande camper e caravan in caso di vento. Il kit comprende: 1 nastro stabilizzatore (13 m) con molla di tensione e grandi picchetti di ancoraggio.



STABILIZER KIT UNIVERSAL

Art. 0301315N € 27,90

1,2 kg

Kit cinghie stabilizzanti per verande caravan. Adatto per la maggior parte delle verande di produzione europea con fibbie pre-montate. Il set comprende 2 robusti picchetti di ancoraggio, 2 molle di scarico tensione e 2 cinghie di sicurezza.

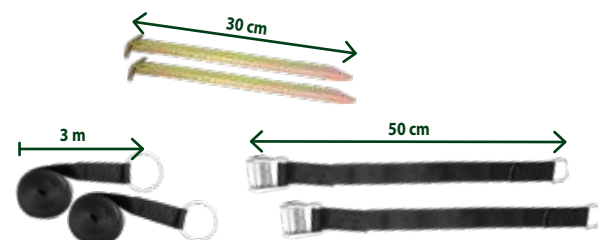

PROP

Art. 0301312N € 39,90

1,2 kg

Sistema stabilizzante per verande e tendalini parasole. Il set è dotato di 2 fibbie (2x 50cm+3m) e 2 picchetti robusti (2x 30cm). Pratica sacca custodia inclusa.





made in EU

EDOS

Art. 0301011C

€ 9,50

Ø 5 mm x 7,3 cm

PACK 6X

Elastico per soprateli di tende a cupola.



made in EU

CIRCLE

Art. 0301022C

€ 5,50

Ø int. 6 cm

PACK 6X

Anello tensione rotondo PVC soft.



HOOKER

Art. 0301023C

€ 8,90

Ø 5 mm x 16 cm

PACK 6X

Controllore di tensione con gancio per tende e verande.

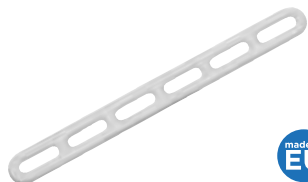

made in EU

SIX-PACK

Art. 0301029C

€ 8,50

21,5 x 2,5 cm

PACK 6X

Elastico a scaletta a sei campi, senza linguetta.



FLEXO



FLEXO 8



FLEXO 12



FLEXO NT

Anello in gomma per tende.
Elevata resistenza alla rottura.

			PACK	
FLEXO 8	Art. 0301019N	8 x 5 x 4 cm	10X	€ 6,50
FLEXO 12	Art. 0301020N	12 x 4 x 5 cm	10X	€ 6,50
FLEXO NT	Art. 0301021N	11 x 8 x 2 cm	10X	€ 6,50



STRETCH



PACK

Art. 0902001C	Ø 0,8 x 50 cm	2X	€ 8,90
Art. 0902003C	Ø 0,8 x 100 cm	2X	€ 9,90
Art. 0902016C	Ø 0,8 x 150 cm	2X	€ 12,50
Art. 0902017C	Ø 1 x 100 cm	2X	€ 12,50
Art. 0902018C	Ø 1 x 150 cm	2X	€ 15,90

Corda elastica fermabagagli con anima in gomma e ganci in acciaio su entrambi i lati.



STRETCH SECURITY



PACK

Art. 0902023C	Ø 0,8 x 100 cm	2X	€ 9,50
Art. 0902024C	Ø 0,8 x 150 cm	2X	€ 11,50

Corda elastica fermabagagli con anima in gomma e ganci in plastica su entrambi i lati.



POWER FIX



PACK

Art. 7710174C	50 x 2 cm	2X	€ 10,50
Art. 7710177C	75 x 2 cm	2X	€ 10,50
Art. 7710175C	100 x 2 cm	2X	€ 10,90
Art. 7710178C	125 x 2 cm	2X	€ 10,90
Art. 7710176C	150 x 2 cm	2X	€ 11,50
Art. 7710179C	200 x 2 cm	2X	€ 12,50
Art. 7710173C	250 x 2 cm	2X	€ 12,90

Cinghiette di fissaggio con fibbia in metallo.



POWER-STRAP



PACK

Art. 7710180C	50 x 2 cm	2X	€ 6,90
Art. 7710182C	75 x 2 cm	2X	€ 7,90
Art. 7710184C	100 x 2 cm	2X	€ 8,90

Cinghietta di fissaggio con fibbia di bloccaggio e regolazione in plastica.



PACK SOLID 2,5

Art. 7710183N

€ 12,50

PACK SOLID 4

Art. 7710185N

€ 14,50

2,5 m x 25 mm

100% Polyester

4,0 m x 25 mm

100% Polyester

Cinghia di fissaggio monopezzo con fibbia di bloccaggio in zinco pressofuso. Estremità della cinghia aperta per la reggiatura. Forza di ancoraggio: 5 daN (250 kg)



PACK-MAN 2.0

Art. 7710187N

€ 15,90

5,0 m x 25 mm

100% Polyester

Cinghia di ancoraggio monopezzo con cricchetto robusto e antiscivolo in acciaio rivestito in gomma. Aree di applicazione: Kayak, barca, tenda, portapacchi, bicicletta, rimorchio, SUP, moto, tavola da surf, camper, caravan. Forza di ancoraggio: 8 daN (400kg)



FORCE

Art. 0203040N

€ 10,50

 32 cm x Ø 55 mm

 500 g

Martello da campeggio con manico in legno e mazzuolo in gomma.



HIT

Art. 0203048N

€ 10,50

 28,5 cm x Ø 52 mm

 390 g

Martello da campeggio con manico antiscivolo. Mazzuolo in gomma piena.



BOMBER

Art. 0203008N

€ 20,90

 31 x 11,3 x 4 cm

 360 g

Martello per camping multifunzione realizzato interamente in metallo con solida testa a 2 battenti martello/piccozza, pratico gancio per l'estrazione dei picchetti e cinturino di sicurezza per la mano.





TRIFOLD

Art. 0203002N

€ 25,50

 58 x 15,5 cm

 23,5 x 15,5 cm

 1,25 kg



Pala/zappa pieghevole in metallo forgiato. Lama seghettata e manico tubolare che viene serrato tramite un mandrino integrato. Completa di custodia.

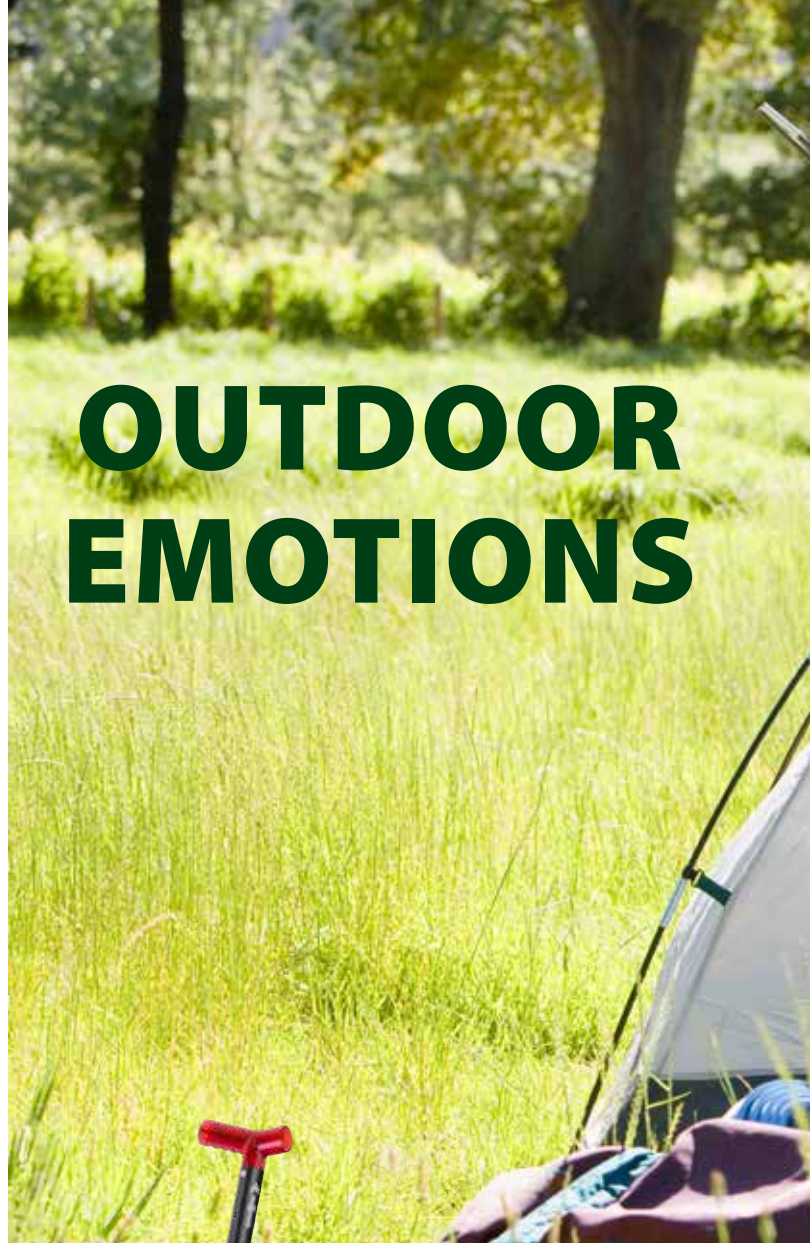



OUTDOOR EMOTIONS

ARLO

Art. 0203012N

€ 51,90

 95 x 21,5 x Ø 3/3,5 cm

 45 x 23 x 6 cm

 720 g



POLYCARBONATE

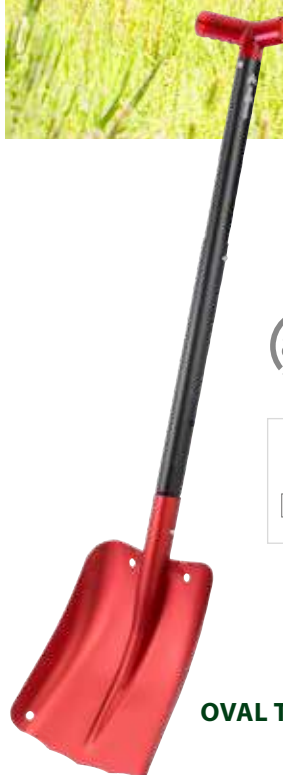

OVAL TUBE



Pala multiuso composta da 3 elementi realizzati in lega di alluminio con impugnatura asimmetrica in plastica. Costruzione resistente per l'outdoor, il campeggio, il survival e la caccia, ecc. Con pratico fodero per il trasporto.

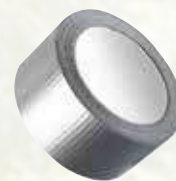

STRATOS

Art. 0202242C.C37

€ 11,50

 25 m x 50 mm

PACK 1X

Nastro telato ad alta resistenza.



POLE KIT



Art. 0103032N	Ø 7,9 mm - 4x 65 cm	€ 10,50
Art. 0103033N	Ø 8,5 mm - 4x 65 cm	€ 11,90
Art. 0103034N	Ø 9,5 mm - 4x 75 cm	€ 13,50
Art. 0103035N	Ø 11 mm - 4x 75 cm	€ 16,90
Art. 0103039N	Ø 12,7 mm - 4x 75 cm	€ 18,50

Set pali di ricambio in fibra di vetro. Il set comprende: 4 pali in fibra di vetro con bocche premontate, un elastico di solidarizzazione e 2 puntali in metallo.



REPAIR KIT



Art. 0103037N	Ø 8,5/9,5 mm	€ 16,90
Art. 0103040N	Ø 11/12,7 mm	€ 21,50

Set riparazione per tende composto da: pali di ricambio in fibra di vetro, elastico solidarizzatore, tessuto tenda e colla per tessuti.



POLECAP



PACK



Art. 0306015C	19 mm	4X	€ 6,50
Art. 0306026C	22 mm	4X	€ 6,90

Ventosa per palo tetto.



POLESPIKE



PACK



Art. 0306018C	19 mm	3X	€ 5,90
Art. 0306019C	22 mm	3X	€ 5,90
Art. 0306020C	25 mm	3X	€ 5,90

Puntale in materiale plastico.



POLEHOOK



PACK



Art. 0306046C	Ø 22 mm	5X	€ 6,90
Art. 0306047C	Ø 25 mm	5X	€ 8,50

Gancio per palo.



POLESTING



PACK



Art. 0306048C	Ø 22 mm	5X	€ 7,50
Art. 0306049C	Ø 25 mm	5X	€ 6,90

Puntale per palo.

POLECLAMP



PACK



Art. 0306051C	Ø 22 - 25 mm	4X	€ 12,50
Art. 0306052C	Ø 25 - 28 mm	4X	€ 12,90

Morsetto per palo.



SMARTLOCK



PACK

Art. 0305060C	22/19 mm	3X	€ 9,90
Art. 0305061C	25/22 mm	3X	€ 11,50
Art. 0305063C	28/25 mm	3X	€ 11,50
Art. 0305067C	32/28 mm	3X	€ 12,50

Blocca-pali in plastica Smartlock. Disponibili per tutti i diametri di paleria più comuni.

ULTERIORI VANTAGGI DEGLI SMARTLOCK:

- Semplice da sostituire
- Sistema di bloccaggio senza viti e privo di parti metalliche
- Nessun danno o deformazione alla paleria
- Adatti a pali in acciaio e alluminio
- Di semplice utilizzo



SUPPORTER



PACK

Art. 0306022C	Ø 22 mm	3X	€ 4,50
---------------	---------	----	--------

Supporto paleria orizzontale in materiale plastico.



MINIBASE

Art. 0306029N € 9,90

Ø 80 x H30 mm

PACK 2X

ROTOBASE

Art. 0306032N € 9,90

Ø 80 x 45 mm

PACK 2X

Base di appoggio per pali verticali, gradini d'entrata, ecc. Prodotto in materiale plastico robusto e stabile.

Base di appoggio con snodo rotante per pali verticali, gradini d'entrata, ecc. Prodotto in materiale plastico robusta e stabile.



BLOCKER SHS



PACK

Art. 0306008C Ø 5 cm 3X € 9,90

Sistema di aggancio senza viti SHS.



STOPPER SHS



PACK

Art. 0306009C 5 x 7 cm 3X € 12,90

Stopper SHS per tutte le verande moderne con doppio profilo di scorrimento.



DOUBLE 8



Art. 7401021N 100 cm € 7,50
 Art. 7401022N 250 cm € 17,50

Profilo di congiunzione in materiale plastico. Ottimo per collegare tendalini a verande.

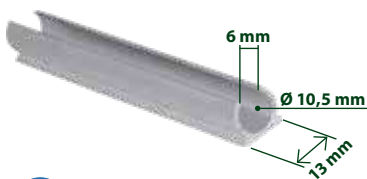

ALU RAIL

Art. 7401023N € 19,90

3 m

Profilo in alluminio anodizzato.

QEDER

Ø 7 mm



QEDER PVC

Art. 7401197N € 4,50

Ø 7 mm, roll 50m x H25 mm

Profilo di scorrimento con flangia larga 25 mm.

Ø 4 mm

Ø 7 mm



QEDER SHS

Art. 7401195N € 5,50

Ø 4/7 mm, roll 50m x H25 mm

Esecuzione come Art. 7401192N ma adatta al sistema di fissaggio senza viti (SHS). Profilo di scorrimento con flangia larga 25 mm.

Ø 5 mm
 Ø 7 mm



QEDER

Art. 7401196N Ø 5 mm, roll 50m x H25 mm € 4,50

Art. 7401192N Ø 7 mm, roll 50m x H25 mm € 4,90

Profilo di scorrimento con flangia larga 25 mm.

QEDER ADAPTER SET



Art. 7401019N Ø 5 mm x 3 m € 51,50

Art. 7401020N Ø 7 mm x 3 m € 49,50

Kit per collegare la tenda minibus al veicolo.

TELEPOLE

TELEPOLE 80-190

Art. 0305034N € 26,90

80 - 190 cm

Palo verticale telescopico in alluminio anodizzato a tre elementi Ø 31/26/21 mm. Con puntale e base.

TELEPOLE 100-230

Art. 0305035N € 29,90

100 - 230 cm

SET TELEPOLE

Art. 0305036N € 67,90

100 - 230 cm

PACK 2X





SMARTPOLE

Pali aggiuntivi per dare alla veranda ulteriore stabilità in caso di vento forte, pioggia o neve. I nostri pali sono disponibili in 2 versioni.

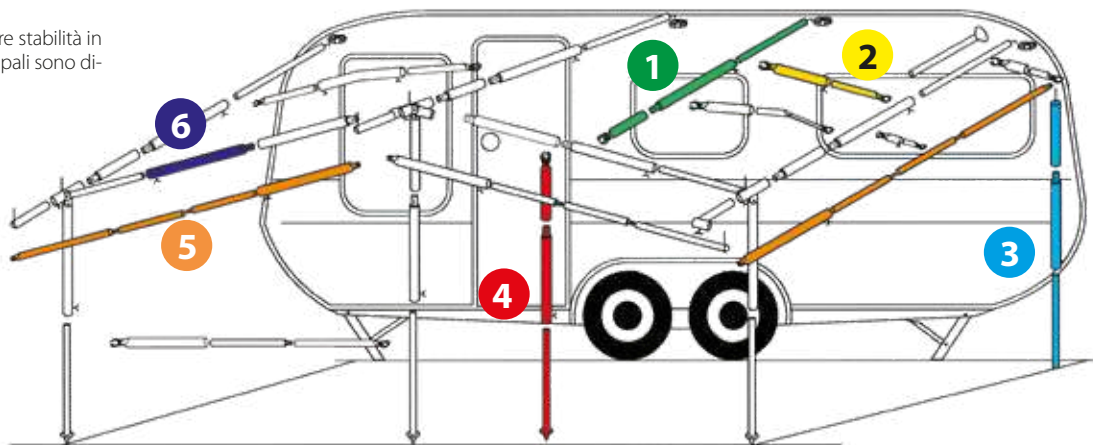

Acciaio: viene utilizzato nelle verande permanenti o invernali a causa della particolare rigidità. Tutti i pali Brunner in acciaio sono stati sottoposti ad un doppio processo di protezione (zincatura e laccatura).



Alluminio: materiale ideale per tende leggere da viaggio e tendalini. Caratteristiche: peso ridotto, praticamente non corrodibile. Tutti i pali Brunner in alluminio dispongono di una superficie anodizzata.

1 SMARTPOLE RIDGE



Acciaio



PACK

Art. 0305021C	Ø 22x1/115-200 cm	1X	€ 21,90
Art. 0305048C	Ø 22x1/170-260 cm	1X	€ 25,90
Art. 0305025C	Ø 25x1/170-260 cm	1X	€ 28,90



PACK

Art. 0305050C	Ø 25x1/170-260 cm	1X	€ 30,50
---------------	-------------------	----	---------

2 SMARTPOLE ROOF SUPPORT



Acciaio



PACK

Art. 0305006C	Ø 22x1/75-120 cm	1X	€ 18,90
Art. 0305041C	Ø 22x1/115-200 cm	1X	€ 23,50
Art. 0305049C	Ø 25x1/115-200 cm	1X	€ 24,50
Art. 0305046C	Ø 22x1/170-260 cm	1X	€ 26,50
Art. 0305057C	Ø 25x1/170-260 cm	1X	€ 29,50



PACK

Art. 0305070C	Ø 25x1/115-205 cm	1X	€ 26,90
Art. 0305071C	Ø 25x1/170-260 cm	1X	€ 32,50



3 SMARTPOLE UP-RIGHT



Acciaio



PACK

Art. 0305022C	Ø 22x1/110-200 cm	1X	€ 20,90
Art. 0305028C	Ø 22x1/165-250 cm	1X	€ 25,50



PACK

Art. 0305037C	Ø 25x1/110-200 cm	1X	€ 25,90
Art. 0305038C	Ø 25x1/165-250 cm	1X	€ 29,50

4 SMARTPOLE STORM



Acciaio



PACK

Art. 0305103C	Ø 22x1/115-200 cm	1X	€ 23,50
Art. 0305047C	Ø 22x1/170-260 cm	1X	€ 25,90
Art. 0305098C	Ø 25x1/170-260 cm	1X	€ 29,50



PACK

Art. 0305145C	Ø 25x1/115-200 cm	1X	€ 26,90
Art. 0305146C	Ø 25x1/170-260 cm	1X	€ 31,50

5 SMARTPOLE TENSION FLAT ENDS



Acciaio



PACK

Art. 0305024C	Ø 22x1/110-200 cm	1X	€ 16,50
Art. 0305023C	Ø 22x1/200-280 cm	1X	€ 19,50



PACK

Art. 0305032C	Ø 25x1/110-200 cm	1X	€ 19,50
Art. 0305033C	Ø 25x1/200-280 cm	1X	€ 25,50

6 SMARTPOLE EXTENSION



Acciaio



PACK

Art. 0305003C	Ø 19x1/80 cm	1X	€ 11,90
Art. 0305002C	Ø 25x1/80 cm	1X	€ 12,90
Art. 0305001C	Ø 22x1/80 cm	1X	€ 14,50



PACK

Art. 0305044C	Ø 25x1/80 cm	1X	€ 14,50
---------------	--------------	----	---------



MULTICOVER



COLOR 



Art. 7130270N.C74	200 x 200 cm	€ 13,50
Art. 7130271N.C74	200 x 300 cm	€ 19,50
Art. 7130277N.C74	300 x 300 cm	€ 27,50
Art. 7130272N.C74	300 x 400 cm	€ 37,90
Art. 7130285N.C74	300 x 500 cm	€ 45,90
Art. 7130286N.C74	300 x 600 cm	€ 54,90
Art. 7130287N.C74	300 x 700 cm	€ 62,50
Art. 7130278N.C74	400 x 400 cm	€ 47,90
Art. 7130273N.C74	400 x 500 cm	€ 57,50
Art. 7130279N.C74	400 x 600 cm	€ 68,90
Art. 7130288N.C74	400 x 700 cm	€ 79,50
Art. 7130280N.C74	500 x 500 cm	€ 72,50
Art. 7130274N.C74	500 x 600 cm	€ 85,90
Art. 7130275N.C74	500 x 700 cm	€ 99,90
Art. 7130281N.C74	600 x 700 cm	€ 119,90
Art. 7130276N.C74	600 x 800 cm	€ 139,90
Art. 7130282N.C74	600 x 1000 cm	€ 169,90
Art. 7130283N.C74	800 x 1000 cm	€ 226,90



Teloni di copertura in PE laminato su entrambi i lati.



GROMMET

Art. 0202044N

€ 8,90

 Ø int. 11 mm

PACK 8X

Set di occhielli in plastica per teloni.



EYELET

Art. 0202045N

€ 19,90

 Ø int. 10 mm

PACK 20X

Occhielli in ottone completi di kit di montaggio.



CONNEX

Art. 0202053N

€ 12,50

 Ø 2,5 cm

PACK 10X

Set di bottoni in materiale plastico.



SNAP

Art. 0202054N

€ 13,50

 Ø int. 10 mm

PACK 8X

Bottoni a pressione in metallo nichelato completi di kit per l'applicazione.

MULTICOVER



MULTICOVER HD



COLOR C06



Art. 7130290N.C06	200 x 200 cm	€ 7,90
Art. 7130291N.C06	200 x 300 cm	€ 11,90
Art. 7130292N.C06	300 x 300 cm	€ 16,90
Art. 7130293N.C06	300 x 400 cm	€ 21,90
Art. 7130294N.C06	400 x 400 cm	€ 29,90
Art. 7130295N.C06	400 x 500 cm	€ 36,90
Art. 7130296N.C06	400 x 600 cm	€ 43,90



Teloni di copertura in polietilene, spalmati su entrambi i lati. Dotati di occhielli su tutti gli angoli e lungo i bordi rinforzati per un fissaggio semplice. Ideale per coprire e proteggere dalle intemperie mobili da giardino e camping, rimorchi, biciclette, catini di tende e verande ed equipaggiamento vario tra cui anche materiale edile.



TARPCLIP

Art. 0301051N

€ 9,50

4 x 8 cm

PACK 4X

Morsetto rapido per stuoie veranda, tappeti e teloni. Prodotto in nylon rinforzato con fibra di vetro di lunga durata.



TARPEYE

Art. 0301054N

€ 12,50

5 x 10 cm

PACK 4X

Occhiello in plastica per teloni.



BUNGEE BALL

Art. 0301057C

€ 10,50

Ø int. 10 mm

PACK 6X

Sfera bloccateli con elastico per occhielli di diametro massimo 25 mm.



CLAMP

Art. 0301060C

€ 3,90

25 mm x Ø 4 mm

PACK 4X

Aggancio per stuoie e teloni. In plastica flessibile.



FLOOR & DOOR

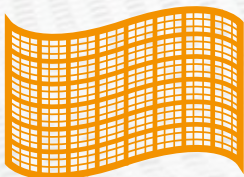

**STUOIE E PEDANE
TENDE PER PORTE**



	PARAGON	PURAMAT	BALMAT	TRIP	BRIOLITE	YUROP	KINETIC	KINETIC	KINETIC
TESSUTO	PE	PES	PP	PP	PP	PVC/PES	PVC/PET	PVC/PET	PVC/PET
PESO TESSUTO	250 g/m ²	350 g/m ²	350 g/m ²	200 g/m ²	300 g/m ²	450 g/m ²	400 g/m ²	500 g/m ²	600 g/m ²
SENZA FTALATI	■	-	■	■	■	■	■	■	■
TAGLIABILE A FREDDO	-	-	-	-	-	■	■	■	■
TRASPIRANTE	■	■	■	■	■	■	-	-	-
IN ROTOLI	-	-	-	■	■	■	■	■	■
IN TAGLI	■	■	■	■	■	■	■	■	■



PARAGON



PARAGON



PHTHALATE free



BAG



Art. 0201284N	250 x 300 cm	€ 43,90
Art. 0201286N	250 x 400 cm	€ 51,90
Art. 0201288N	250 x 500 cm	€ 59,90
Art. 0201290N	250 x 600 cm	€ 67,90

C52



La stuoia Paragon è la soluzione ideale per le verande ed i tendalini di roulotte e camper, absidi tende, cucinotti e gazebo. Completa di lati bordati ed occhielli.

CARATTERISTICHE:

- Traspirante
- Realizzata in tessuto eco-compatibile
- Protegge efficacemente contro gli insetti fastidiosi
- Facile da pulire
- Materiale durevole
- Dotata di pratici occhielli
- Resistente ai raggi UV
- Imputrescibile
- Resistente alle intemperie
- Con borsa per il trasporto

PURAMAT

Stuoia per tende e tendalini, antipolvere ed anti-sabbia e realizzata con un nuovo materiale in poliestere appositamente lavorato.

CARATTERISTICHE:

- Permeabile all'aria
- Idrorepellente
- Leggera
- Facile da piegare
- Non si sfilaccia
- Durevole
- Con anelli di fissaggio agli angoli
- Incl. borsa custodia



PURAMAT



Art. 0201251N	250 x 300 cm	€ 56,90
Art. 0201252N	250 x 350 cm	€ 63,90
Art. 0201253N	250 x 400 cm	€ 75,90
Art. 0201254N	250 x 450 cm	€ 82,90
Art. 0201255N	250 x 500 cm	€ 92,90





BALMAT



BAG



Art. 0102044N	250 x 300 cm	€ 71,90
Art. 0102045N	250 x 350 cm	€ 79,90
Art. 0102046N	250 x 400 cm	€ 89,90
Art. 0102047N	250 x 450 cm	€ 99,90
Art. 0102064N	250 x 500 cm	€ 105,90
Art. 0102065N	250 x 600 cm	€ 125,90
Art. 0102066N	250 x 700 cm	€ 139,90

BALMAT

PHTHALATE free



Stuoia per verande leggerissima. Utilizzabile su entrambi i lati. Particolarmente indicata per caravan e camper di dimensioni piccole/medie.

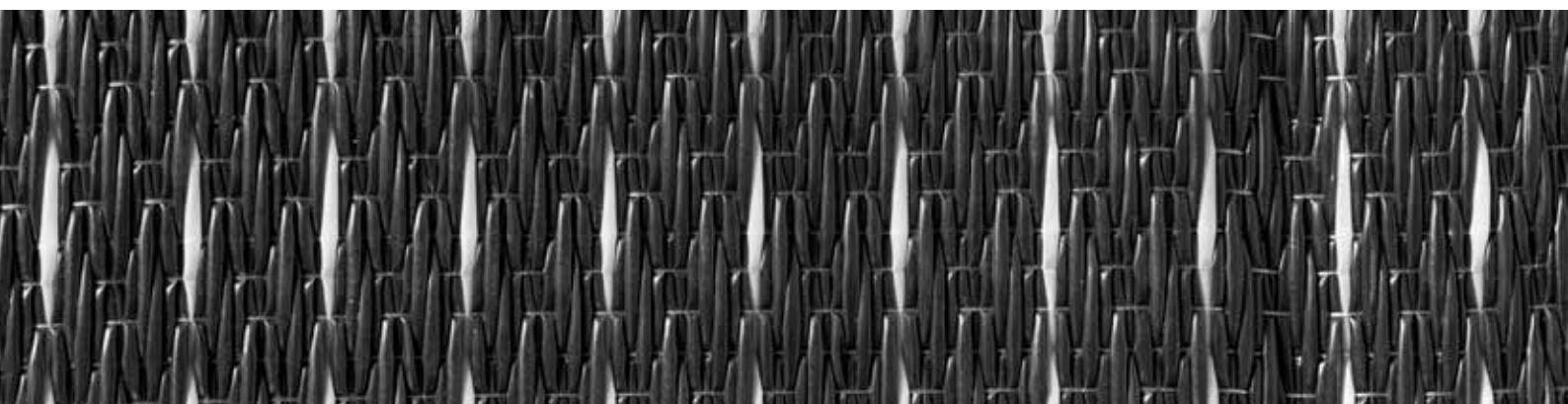



BALMAT



BAG



Art. 0102044N	250 x 300 cm	€ 71,90
Art. 0102045N	250 x 350 cm	€ 79,90
Art. 0102046N	250 x 400 cm	€ 89,90
Art. 0102047N	250 x 450 cm	€ 99,90
Art. 0102064N	250 x 500 cm	€ 105,90
Art. 0102065N	250 x 600 cm	€ 125,90
Art. 0102066N	250 x 700 cm	€ 139,90
Art. 0102067N	300 x 300 cm	€ 84,50
Art. 0102068N	300 x 350 cm	€ 99,50
Art. 0102069N	300 x 400 cm	€ 112,90
Art. 0102070N	300 x 450 cm	€ 124,50
Art. 0102071N	300 x 500 cm	€ 134,90
Art. 0102072N	300 x 600 cm	€ 159,50
Art. 0102073N	300 x 700 cm	€ 186,50

BALMAT

PHTHALATE free



Stuoia per verande leggerissima. Utilizzabile su entrambi i lati. Particolarmente indicata per caravan e camper di dimensioni piccole/medie.

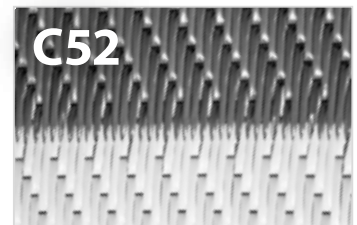

INFO



Stuoia leggera e salvaspazio in fibra di polipropilene a lunga durata. Ideale per il campeggio itinerante, ma anche per le verande delle caravan. La struttura in tessuto traspirante e indeformabile permette al terreno di respirare e crea un piacevole ambiente di soggiorno. Disponibile in varie dimensioni, colori e spessori di materiale.

IN EVIDENZA:

- Facile da pulire
- Lavabile
- Imputrescibile
- Traspirante
- Antistrappo
- Resistente ai raggi UV
- Riciclabile
- Con borsa di trasporto riutilizzabile



TRIP



TRIP

PTHALATE free



€/m

Art. 0201241N H2,5 x 50 m (€/m) € 13,90



Art. 0201242N	250 x 300 cm	€ 56,50
Art. 0201243N	250 x 350 cm	€ 62,50
Art. 0201244N	250 x 400 cm	€ 70,90
Art. 0201245N	250 x 450 cm	€ 76,50
Art. 0201246N	250 x 500 cm	€ 83,50
Art. 0201247N	250 x 600 cm	€ 97,50
Art. 0201248N	250 x 700 cm	€ 107,50

Resistente stuoia per tende e verande.

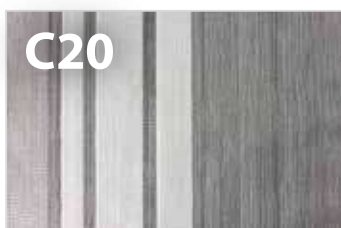

C20



quick dry

**LAVABILE:
ASCIUGA RAPIDAMENTE**



long durability

**LUNGA DURATA
RESISTENTE ALL'USURA**



RESISTENTE ALL'UMIDITA'



**RESISTENTE AI
RAGGI UV**



BRIOLITE



BRIOLITE

PTHALATE free



€/m

Art. 0201076N H 2,5 x 50 m (€/m) € 16,90



Art. 0201091N	250 x 300 cm	€ 71,50
Art. 0201092N	250 x 350 cm	€ 79,50
Art. 0201093N	250 x 400 cm	€ 88,50
Art. 0201094N	250 x 450 cm	€ 96,90
Art. 0201095N	250 x 500 cm	€ 103,90
Art. 0201096N	250 x 600 cm	€ 122,90
Art. 0201097N	250 x 700 cm	€ 139,90

Stuoia per tende e verande in tessuto PP.

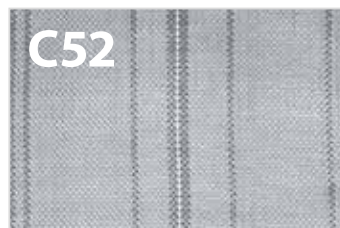

C52



C57

YUROP

YUROP



€/m

Art. 0201074N	H2,5 x 30 m (€/m)	€ 16,90
Art. 0201075N	H3 x 30 m (€/m)	€ 20,50



Art. 0201077N	250 x 300 cm	€ 73,50
Art. 0201081N	250 x 350 cm	€ 80,50
Art. 0201082N	250 x 400 cm	€ 93,50
Art. 0201083N	250 x 450 cm	€ 106,50
Art. 0201088N	250 x 500 cm	€ 117,50
Art. 0201089N	250 x 600 cm	€ 137,90
Art. 0201078N	300 x 300 cm	€ 85,50
Art. 0201079N	300 x 400 cm	€ 107,90
Art. 0201080N	300 x 500 cm	€ 137,50
Art. 0201084N	300 x 600 cm	€ 165,90
Art. 0201085N	300 x 700 cm	€ 188,50

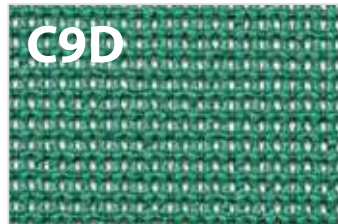
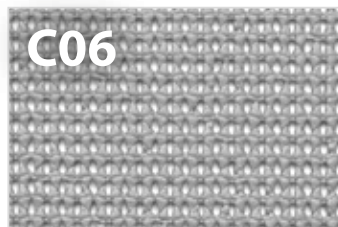

Stuoia per tende e verande in filo di poliestere schiumato.



PHTHALATE free

La stuoia Yurop è un classico quando si è in tema di accessori per il campeggio. La sua robustezza, la sua elasticità ed il suo comfort al tatto la rendono una soluzione estremamente pratica da usare per rendere il pavimento delle tende o delle tende da sole elegante e accogliente. Disponibile in diverse taglie.

CARATTERISTICHE:

- Facile da pulire
- Tagliabile
- Imputrescibile
- Piacevole comfort al tatto
- Traspirante
- Antistrappo
- Resistente ai raggi UV
- Antiscivolo
- Con borsa di trasporto riutilizzabile

CARPEG

Art. 0303013C

€ 8,90



20 cm x Ø 6 mm

PACK 6X

Spillone chiodo fermastuoia in acciaio con ranella Ø 38 mm in materiale plastico.



PEGGY

Art. 0303019C

€ 5,50



20 cm x Ø 8 mm

PACK 6X

Speciale picchetto in metallo per fissare stuoie e teloni.



PICKET

Art. 0303018C

€ 5,50



12 cm x Ø 2 cm

PACK 6X

Picchetto fermastuoia in materiale plastico.





KINETIC



Stuoia per verande di ottima qualità perfettamente indicata sia per campeggio stanziale che quello itinerante ed abbinabile a verande caravan, verande avvolgibili, tendalini parasole e tende per minivan. Realizzata in ottima fibra sintetica resistente ai raggi UV. Utilizzabile su entrambi i lati. Idrorepellente, imputrescibile e facile da pulire. Accorciabile a freddo senza pericolo che si sfrangi. Senza ftalati. Disponibile in ben 12 misure pretagliate ed in 3 grammature di tessuto, selezionabili a seconda dell'utilizzo previsto.

PHTHALATE free

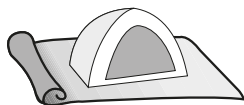
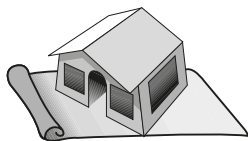
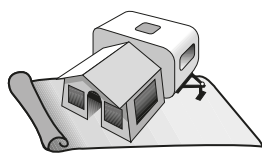

Stuoia per verande di ottima qualità perfettamente indicata sia per il campeggio stanziale che per quello itinerante. Disponibile in 3 grammature di tessuto, selezionabili a seconda dell'utilizzo previsto.

CARATTERISTICHE:

- Tessitura speciale ad alta resistenza
- Utilizzabile su entrambi i lati
- Accorciabile a freddo
- Imputrescibile
- Idrorepellente
- Lavabile
- Senza ftalati

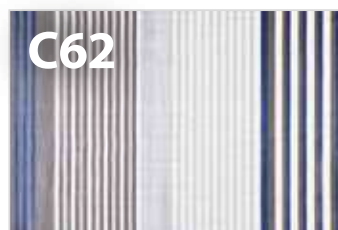

C62

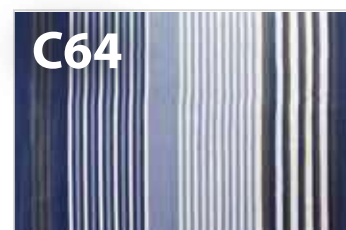

C64

KINETIC 400



ROLL



€/m

Art. 0201136N

H2,5 x 30 m (€/m)

€ 27,50



BAG



Art. 0201137N

250 x 300 cm

€ 82,90

Art. 0201138N

250 x 350 cm

€ 96,50

Art. 0201139N

250 x 400 cm

€ 109,90

Art. 0201146N

250 x 450 cm

€ 125,50

Art. 0201147N

250 x 500 cm

€ 138,50

Art. 0201148N

250 x 600 cm

€ 166,50

Art. 0201149N

250 x 700 cm

€ 193,90

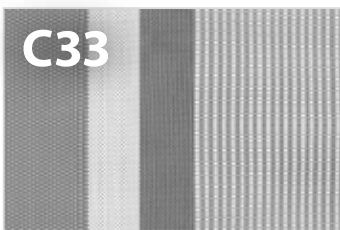

C33



C31



C63



C52



C59

KINETIC 500



€/m

Art. 0201260N	H2,5 x 30 m (€/m)	€ 27,50
Art. 0201261N	H3 x 30 m (€/m)	€ 32,90



Art. 0201262N	250 x 300 cm	€ 86,90
Art. 0201263N	250 x 350 cm	€ 103,50
Art. 0201264N	250 x 400 cm	€ 115,50
Art. 0201265N	250 x 450 cm	€ 134,50
Art. 0201266N	250 x 500 cm	€ 147,50
Art. 0201267N	250 x 600 cm	€ 177,50
Art. 0201268N	250 x 700 cm	€ 205,90
Art. 0201269N	300 x 300 cm	€ 106,50
Art. 0201270N	300 x 400 cm	€ 138,50
Art. 0201271N	300 x 500 cm	€ 178,50
Art. 0201272N	300 x 600 cm	€ 211,90
Art. 0201273N	300 x 700 cm	€ 243,50

KINETIC 600



€/m

Art. 0201105N	H2,5 x 30 m (€/m)	€ 30,90
Art. 0201118N	H3 x 30 m (€/m)	€ 34,90



Art. 0201106N	250 x 300 cm	€ 94,90
Art. 0201107N	250 x 350 cm	€ 108,50
Art. 0201108N	250 x 400 cm	€ 121,50
Art. 0201109N	250 x 450 cm	€ 137,50
Art. 0201110N	250 x 500 cm	€ 152,90
Art. 0201111N	250 x 600 cm	€ 187,50
Art. 0201112N	250 x 700 cm	€ 214,90
Art. 0201131N	300 x 300 cm	€ 111,50
Art. 0201132N	300 x 400 cm	€ 143,90
Art. 0201133N	300 x 500 cm	€ 183,90
Art. 0201134N	300 x 600 cm	€ 221,90
Art. 0201135N	300 x 700 cm	€ 256,50



DECK

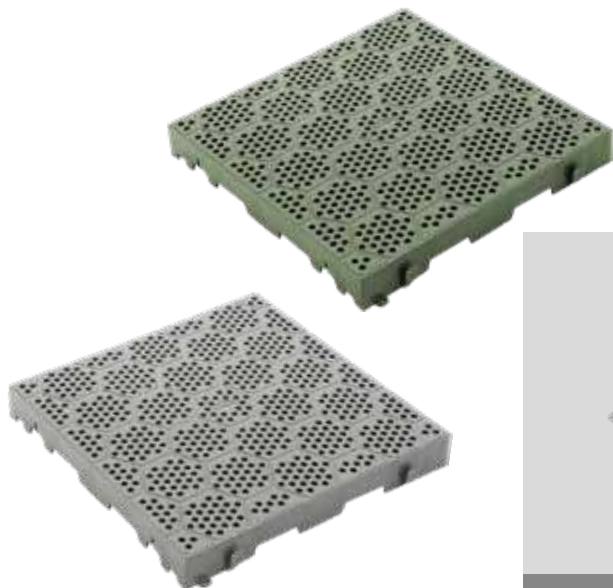

DECK-FIT

Art. 0201032N

€ 12,50

 38,5 x 38,5 x H5 cm

 1,2 kg

 PP / PE

 4,5 t/m²

 COLORS  

Mattonelle Deck-Fit in materiale plastico per la realizzazione di pavimentazioni esterne di vario tipo.

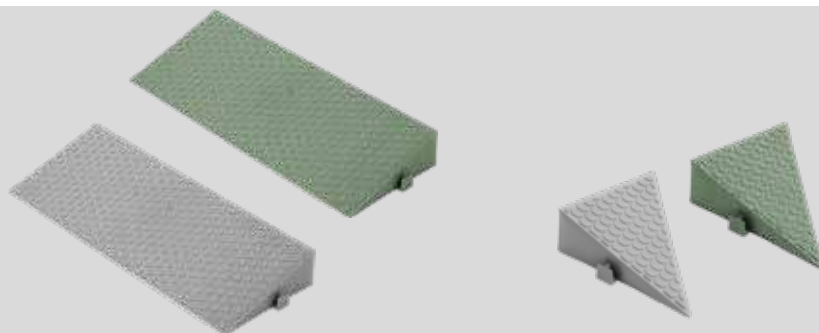



OPTIONAL

DECK RAMP



Art. 0201033N

€ 8,50

 38,5 x 15 x H5 cm

 220 g

 100% PP

 COLORS  

Rampa laterale per mattonelle Deck-Fit. Con elementi di collegamento.

DECK CORNER



Art. 0201036N

€ 8,50

 20,5 x 15 x H5 cm

 60 g

 100% PP

 COLORS  

Angolare per mattonelle Deck-Fit.



HELLO



HELLO CAMPER

Art. 0201034N.CA

€ 12,90

25 x 50 cm

100% PP



TRIMMAT S

Art. 0201037N

€ 10,50

25 x 50 cm

RUBBER

HELLO CARAVAN

Art. 0201034N.CV

€ 12,90

25 x 50 cm

100% PP



TRIMMAT L

Art. 0201038N

€ 14,50

40 x 60 cm

RUBBER

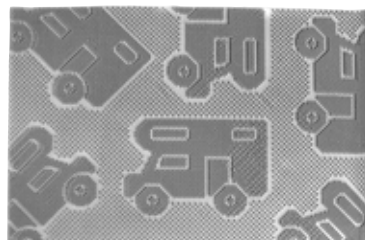
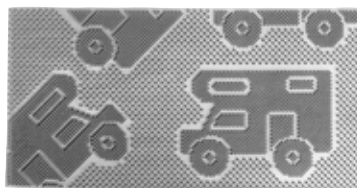

ZERBY

Art. 7225150N

€ 25,50

34 x 27,5 x 6 cm

980 g



Pratico zerbino con simpatici motivi legati al camper e alla caravan. Protegge gli interni del mezzo da terra, polvere e sporco. Dotato di rivestimento inferiore antisdrucciolo.

Pratico zerbino realizzato in gomma molto resistente. Ideale per l'uso esterno. Colore grigio.

Zerbino con struttura in legno.



ACAPULCO



Art. 7233100N	56 x 185 cm	€ 36,50
Art. 7233105N	56 x 205 cm	€ 42,90
Art. 7233101N	70 x 205 cm	€ 49,90
Art. 7233102N	100 x 205 cm	€ 66,50



Tendina in ciniglia di ottima qualità per tempo il libero, la casa e il giardino.

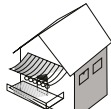
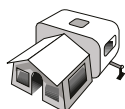
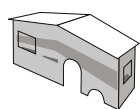
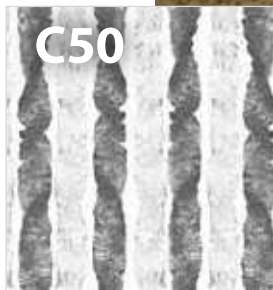
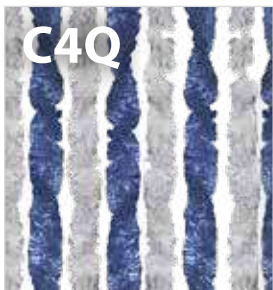
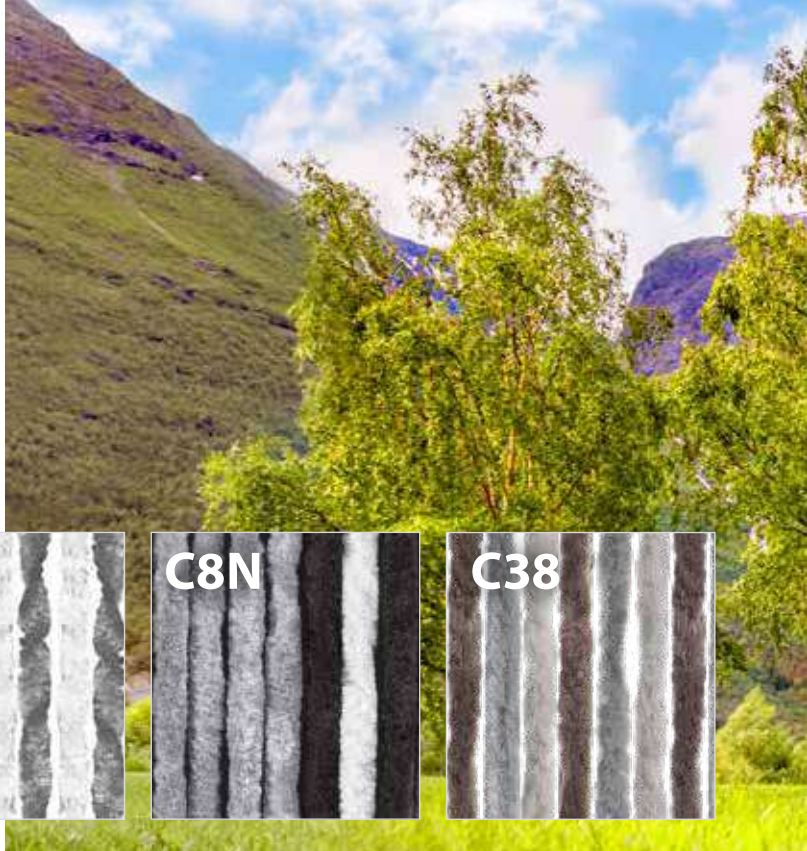

MEANDER

Art. 7232149N € 54,50

60 x 190 cm

100% PVC

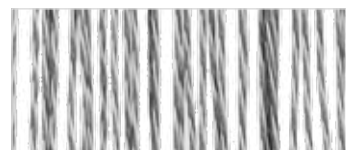

Tendina in plastica con filamenti intrecciati.

ACAPULCO



ZANZIBAR S

Art. 7232150N

€ 34,90

 56 x 185 cm

 100% PP

ZANZIBAR L

Art. 7232152N

€ 42,90

 100 x 200 cm

 100% PP

RIBBON

Art. 7232154N

€ 50,90

 60 x 190 cm

 100% PVC



Tenda antizanzare dai molteplici impieghi.

Tenda per porte realizzata in materiale plastico PVC 100% riciclabile.





LAMPS & LANTERNS



LANTERNE CAMPING
LAMPADE PER TENDE
LAMPADE FRONTALI

LAMPARINA

Art. 0720068N

€ 39,90

NEW
2023

3,7V Li-Ion - 4000mAh

120 lumen

15h

Tungsten Led bulb

Ø 10,3 x H16,4 cm

375 g

6W

Energy class
in process of approval

Lanterna ricaricabile per Outdoor e Camping dal look professionale. Dona una luce piacevole grazie all'illuminazione a LED di colore bianco caldo. Dotata di 2 livelli di intensità luce e di uno schermo in materiale plastica traslucente. Con pratica maniglia in acciaio per il trasporto o per appenderla. La batteria integrata agli ioni di litio può essere ricaricata con il cavo USB in dotazione.

NEW
2023

LYSS

Art. 0720066N

€ 53,90

18650 Li-ion - 5200mAh

15-450 lumen

6-200 h

30

Ø 12,6 x H30,5cm (included handle)

560 g

8W

Energy class
in process of approval

Elegante lanterna LED con resistente struttura realizzata in metallo verniciato, base in bambù e schermo traslucente in materiale plastico. Dotata di interruttore dimmer ON-OFF con 2 modalità di illuminazione: una a luce calda ed una a luce bianca. La batteria integrata agli ioni di litio può essere ricaricata con il cavo USB in dotazione. Utilizzabile in molteplici applicazioni.

INFO



LED - (Light Emitting Diode) fanno parte del gruppo dei semiconduttori ed hanno un consumo ridottissimo di energia (solo il 5-10% di una normale lampadina ad incandescenza), sono molto resistenti ed eccellono per la loro lunghissima durata (in media oltre 10 anni). Il cono luce prodotto dai LED si è dimostrato molto vantaggioso per la maggior parte delle applicazioni possibili. Inoltre risulta essere più piacevole per l'occhio umano rispetto al raggio concentrato puntiforme delle tradizionali torce elettriche che sono comunque ottime per illuminare a lunga distanza.





BLAZE RG LED

Art. 0720032N

€ 65,90

- 3,7V / 4000mAh RG Li-Ion
- 600 lumen
- 12 h
- 4
- Ø 130 x H210 mm
- 900 g
- 20W



Energy class
in process of approval



4 BRIGHTNESS LEVELS

Potente lanterna a LED indipendente o da appendere con robusto involucro in plastica per una posizione sicura e stabile. Con maniglia in metallo per il trasporto. 4 livelli di luminosità. Questa lanterna è adatta per una varietà di funzioni come il campeggio, la speleologia, la pesca ed altre attività all'aria aperta.

CARATTERISTICHE:

- Batterie ricaricabili
- Con presa USB



MIZAR

Art. 0720062N

€ 20,50

- 3xAA (1,5V) not incl.
- 90 lumen
- 16h
- 1
- 4,7 x 4,7 x H9/15 cm
- 100 g



Lanterna LED, molto compatta quando richiusa. Corpo lanterna in ABS. Leggera e semplice da riporre. Completa di interruttore ON/OFF con modalità Flash, gancio per appenderla e magnete di fissaggio. Funzionamento a batteria.



ALTAIR

Art. 0720064N

€ 59,90

- 3,7V / 4200mAh Li-Ion RG
- 200 lumen
- 40h
- 1 x 5W
- Ø 13 x H25 cm
- 700 g



Energy class
in process of approval



Lanterna Outdoor ricaricabile dotata di potente LED da 5W. Corpo lanterna in ABS con paralume in resistente policarbonato. Completa di interruttore ON/OFF con regolazione di luminosità e pratica maniglia per il trasporto.



POLLUX

Art. 0720063N

€ 34,50

- 1800mAh Li-Ion
- 40-150 lumen
- 8h
- 6
- 8,6 x H5,7/14 cm
- 177 g
- 1W



Energy class
in process of approval



Lanterna solare LED con paralume collassabile. Molto compatta quando richiusa. Leggera e semplice da riporre. Completa di interruttore ON/OFF e gancio per appenderla. Si ricarica mediante cellula fotovoltaica integrata o presa USB.



Lanterna da campeggio LED con alimentazione a batteria.

ARKA

Art. 0720040N

€ 27,50

3xD (not incl.)

72 lumen

15h

12

Ø 8,5 x H19,5/27,5 cm

385 g

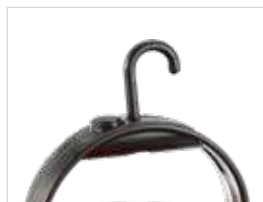

Lanterna LED a batteria.

LYRA

Art. 0720028N

€ 42,50

4xD

120 lumen

15h

20

Ø 11,5 x H31/25,5 cm

700 g



Lanterna LED solare per Outdoor, caravanning e altre attività notturne.

GEMINI

Art. 0720029N

€ 83,50

12V - 220V RG Ni-Mh - Solar 4W

200 lumen

10h

15

Ø 15,7 x H34/26 cm

1,5 kg



Energy class in process of approval



RECHARGEABLE
12V / 220V

LED HIGHPOWER
200 lumen



Lampada Outdoor a LED con cavi USB integrati che consentono di collegare tra loro, in serie, fino a 4 luci. Luminosa e leggera, la lampada a catena fornisce 200 Lumen per l'illuminazione di tende, tende da sole e gazebo. Il paralume regolabile è realizzato in morbido silicone e permette di scegliere tra luce soffusa o spot. Basso consumo energetico per una luce di lunga durata ottenibile da qualsiasi porta USB. Include un moschettone per appendere.

CARATTERISTICHE:

- Corpo lampada: termoplastica con diffusore in silicone
- Diametro lampada: 30 mm
- Collegamento elettrico: tramite spina USB
- Collegamento in serie: tramite connettore USB femmina

NEXUS LED

Art. 0720065N

€ 12,90

USB plug 5V

200 lumen

6

Ø 5 cm / 2m power line / 20cm connection line

100 g

5W



Energy class in process of approval



LED HIGHPOWER
200 lumen





NOCTILUS

Art. 0720060N

€ 8,90

3xAA (not incl.)

140 lumen

5-15 h

3x5050 SMD

Ø 7 x H4 cm

68 g



Lampada LED a sospensione per illuminare l'interno di tende a 360°. Funzionamento a batteria.



LUMINA

Art. 0720061N

€ 12,90

1xAA (not incl.)

25 lumen

8h+

1

Ø 6 x H10,5 cm

60 g

0,5W



Lampada per tende con interruttore a 3 livelli di luminosità e pratico gancio per appendere.



1 click high
2 click low
3 click flashing light

GLOBE LED

Art. 0720009N

€ 13,90

3,7V 2400mAh

98-394 lumen

8-15 h

42

Ø 10,4 x H17,3 cm

180 g

21W



Energy class
in process of approval



RECHARGEABLE

Lampada LED a basso consumo energetico realizzata con corpo in resistente ABS e schermo in materiale plastico trans lucente che genera una luce uniforme. Il pulsante ON-OFF integrato permette di selezionare più livelli di intensità luce per illuminare l'ambiente circostante in maniera ottimale. Completa di gancio in metallo per appenderla e presa Micro-USB per la ricarica. Facile da trasportare grazie alle sue dimensioni compatte. Ottima per l'utilizzo Outdoor e Camping.

TABIT

Art. 0720012N

€ 14,50

3xLR3/AAA (not incl.)

39 g

75 lumen

3



RED LIGHT



WHITE LIGHT



Lampada frontale ultraleggera e molto compatta. Funzionamento a batteria.

CARATTERISTICHE:

- Lampada frontale LED con luce bianca (2X) rossa (1X)
- Riflettore orientabile
- Cinghia di fissaggio regolabile



SYRMA LED

Art. 7521018N

€ 57,50

	230 V
	520 lumen
	32
	Ø 18,5 X H12 cm
	350 g
	15W



DIMMERABLE
0-100%

SIXRAY

Art. 7521011N

€ 39,90

	230V AC
	250 lumen
	5W
	Ø 50 x H25 cm
	400 g
	3h



Lampada LED per tende e verande. Corpo pieghevole in silicone (sistema Fold-Away).

CARATTERISTICHE:

- Corpo in silicone
- Moderna tecnologia LED per oscuramento graduale (dimmer)
- Con gancio di sospensione e cavo di collegamento da 5 m
- Sistema di regolazione dell'altezza
- Interruttore ON-OFF

Lampadario ad ombrello a sei raggi completo di lampadina LED a bulbo con batteria ricaricabile integrata. Completo di cavo di collegamento e interruttore ON/OFF.



JABBA RG LED

Art. 0720006N

€ 27,50

	3,7V / 1200mAh lithium - 18650 RG
	60 x 40 x 35 mm
	74 g
	1
	3W

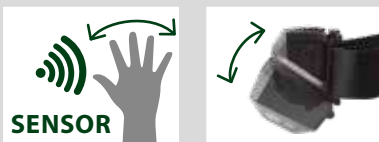

RED LIGHT



WHITE LIGHT



SENSOR RECEIVER

Lampada frontale LED ricaricabile con riflettore orientabile. Attivazione manuale o senza contatto mediante sensore. La moderna tecnologia LED fornisce una luce molto intensa.

CARATTERISTICHE:

- Attivazione manuale (con pulsante) o senza contatto mediante sensore
- Ricaricabile con batterie integrate
- Riflettore orientabile
- Strisce riflettenti sulla fascia
- Corpo in resistente materiale plastico
- Viene fornito con cavo di ricarica Micro-USB



SLEEP & RELAX



SACCHILETTO
MATERASSINI
AMACHE



INFO

SACCO A PELO

Il sacco a pelo è uno degli elementi più importanti dell'attrezzatura outdoor. Solo chi dorme e riposa bene può recuperare durante la notte ed iniziare il nuovo giorno in piena forma. La funzione di un sacco a pelo è relativamente semplice: conservare il calore del corpo e creare un clima piacevole all'interno del sacco stesso. I sacchi a pelo con imbottitura in fibra sintetica sono caratterizzati dal fatto che assorbono solo piccole quantità di umidità. Essi sono quindi adatti per l'uso in paesi o regioni con elevata umidità relativa ed un'alta probabilità di precipitazioni. Inoltre, il loro prezzo è solitamente più contenuto. I sacchi a pelo in piumino d'oca invece hanno più difficoltà con alti livelli di umidità. L'imbottitura rischia di diventare grumosa e quindi perdere il suo Loft e le sue proprietà di isolamento altrimenti eccellenti. Tuttavia, questo tipo di sacchi a pelo si distingue per il suo peso ridotto, la dimensione molto compatta quando chiusi ed il lungo ciclo di vita (se utilizzati e conservati correttamente).



La collezione Delphin offre fantastici sacchi a pelo con cappuccio realizzati con materiali di alta qualità per garantire durata, comfort e leggerezza. L'imbottitura è costituita da fibre cave che catturano il calore nel sacco a pelo e mantengono il corpo caldo e confortevole. Ideale per il campeggio, le attività all'aperto e persino per i camper e le tende da tetto.

CARATTERISTICHE:

- Peso ridotto
- Struttura ad 1 strato
- 2 intervalli di temperatura in base al modello
- Cappuccio staccabile (cerniera)
- Può essere usato come coperta quando è aperto
- Cerniera: YKK a 2 vie - Autolock- forma a L
- Predisposto per lenzuolo interno
- Senza PFC
- Con borsa rettangolare per il trasporto

DELPHIN 90

Art. 0428022N

€ 95,90

DELPHIN 150

Art. 0428027N

€ 111,90

230 x 85 cm

50 x 45 x 23 cm

2,1 kg

1

100% Cotton

20D 380T Nylon

900g Microfiber 100% - Polyester

-12 / 3 / 7

230 x 90 cm

48 x 46 x 27 cm

3 kg

1

100% Cotton

20D 380T Nylon

1550g Microfiber 100% - Polyester

-26 / -8 / -2



2-way zipper



Carry bag





I sacchi a pelo Vandora sono il compagno ideale per tutti i luoghi in cui lo spazio è ridotto, ad esempio nei van, nei minibus o nelle tende a tetto. Tuttavia, i due modelli di questa collezione offrono molto spazio e libertà di movimento per mettersi a proprio agio, oltre alla possibilità di aprirli come una coperta e, non da ultimo, un formato molto compatto una volta riposti nei loro sacchi di compressione. Entrambi i sacchi a pelo hanno una pratica tasca per il cuscino nel cappuccio e una tasca interna per i piccoli oggetti.

CARATTERISTICHE:

- Dimensioni compatte
- Struttura a 1 strato
- 2 intervalli di temperatura in base al modello
- Cappuccio staccabile (cerniera)
- Può essere usato come coperta quando è aperto
- Cerniera: YKK a 2 vie - Autolock - forma a L
- Predisposto per lenzuolo interno
- Senza PFC
- Con sacco a compressione

VANDORA 35

Art. 0428034N

€ 69,90

	220 x 80 cm
	Ø 17 x H 18 cm
	915 g
	1
	100% Cotton
	300T Polyester
	350g Microfiber 100% - Polyester
	-2 / 9 / 13

VANDORA 70

Art. 0428035N

€ 77,90

	220 x 80 cm
	Ø 22 x H 18 cm
	1,2 kg
	1
	100% Cotton
	300T Polyester
	700g Microfiber 100% - Polyester
	-10 / 4 / 8

**2-way zipper****Carry bag**



NEW
2023



NEMOS 120

Art. 0428031N

€ 114,90

NEMOS 160

Art. 0428032N

€ 119,90

235 x 90 cm

48 x 46 x 23 cm

2,4 kg

2

Flannel

110/76 80/20TC

1200g Microfiber 100% - Polyester

-15 / 0 / 5

235 x 90 cm

48 x 46 x 27 cm

3 kg

2

Flannel

110/76 80/20TC

1600g Microfiber 100% - Polyester

-28 / -9 / -3

Il sacco a pelo Nemos 120 è un'ottima scelta per chi cerca il riposo perfetto. Offre praticamente tutto ciò che si può desiderare da un sacco a pelo per le attività outdoor. La classica forma rettangolare offre molto spazio e facilità di movimento. Allo stesso tempo, la fodera in flanella assicura una sensazione di comfort. L'intervallo di temperatura coperto dall'isolamento sintetico di alta qualità è ideale per le attività outdoor dalla primavera all'autunno. E se dovesse fare troppo caldo, la cerniera a L a due vie consente una piacevole ventilazione.

CARATTERISTICHE:

- Sacco a pelo grande con cappuccio
- Costruzione a 2 strati sfalsati
- Può essere utilizzato come coperta quando è aperto
- Cuscino integrato
- Cappuccio staccabile (cerniera)
- Cerniera: YKK a 2 vie - Autolock- forma a L
- Predisposto per lenzuolo interno
- Accoppiabile
- Senza PFC
- Con borsa rettangolare per il trasporto

Per i campeggiatori più esigenti, il sacco a pelo rettangolare Nemos 160 è il partner ideale. Una scelta selettiva di materiali adatti assicura che l'utente sia tenuto al caldo in tutte e 4 le stagioni, fornendo allo stesso tempo una piacevole sensazione di comfort e benessere nelle notti più fredde. Se necessario, è possibile collegare 2 sacchi a pelo tramite una zip per formare un sacco a pelo doppio.

CARATTERISTICHE:

- Sacco a pelo confortevole ed efficiente dal punto di vista del calore con cappuccio
- Costruzione offset a 2 strati
- Può essere utilizzato come coperta quando è aperto
- Cuscino integrato
- Cappuccio staccabile (cerniera)
- Cerniera: YKK a 2 vie - Autolock- forma a L
- Predisposto per lenzuolo interno
- Accoppiabile
- Senza PFC
- Con borsa rettangolare per il trasporto

Pillow pocket

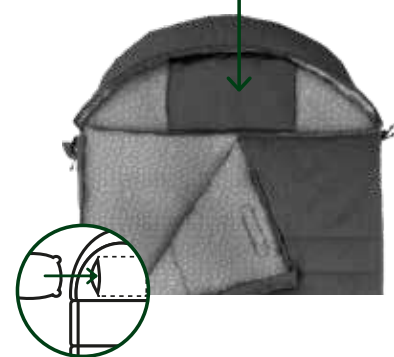

Can be coupled



Carry bag



Detachable hood





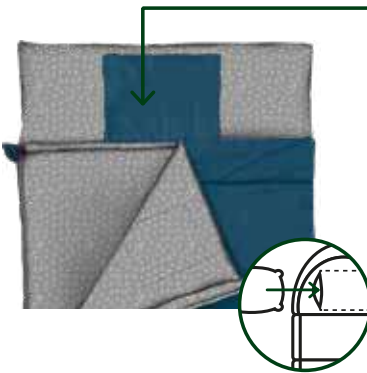





Pillow pocket



STARFLYER

Art. 0428038N









€ 91,90

-  220 x 85 cm
-  Ø 42 x H22 cm
-  1,5 kg
-  2+1
-  100% Cotton
-  240T Nylon Ripstop
-  1000g Microfiber 100% - Polyester
-  Cold side -13 / 2 / 7 - Hot side 2 / 12 / 16

STARFLYER XL

Art. 0428039N

€ 139,90

-  235 x 105 cm
-  Ø 47 x H 26 cm
-  1,95 kg
-  2+1
-  100% Cotton
-  240T Nylon Ripstop
-  1700g Microfiber 100% - Polyester
-  Cold side -16 / 1 / 4 - Hot side 0 / 11 / 14



Can be coupled



Carry bag

Sacco a pelo leggero e confortevole per le notti estive e i soggiorni in camping. I due strati di imbottitura offrono un calore piacevole e accogliente per tutta la notte. Quando lo spazio è limitato, il cuscino integrato e il sacco di compressione incluso semplificano il trasporto. Cappuccio con cerniera. Il sacco a pelo Starflyer può essere facilmente trasformato in una coperta.

CARATTERISTICHE:

- Sacco a pelo rettangolare leggero per le notti estive
- Reversibile
- Struttura a 2 strati sul lato superiore - struttura a 1 strato sul lato inferiore
- Imbottitura molto morbida
- Utilizzabile dalla tarda primavera all'inizio dell'autunno (2/3 stagioni)
- Cappuccio staccabile (cerniera)
- Può essere utilizzato come coperta quando è aperto
- Cuscino integrato
- Cerniera: YKK, a 2 vie - Autolock- L-shape
- Accoppiabile
- Predisposto per lenzuolo interno
- Senza PFC
- Con sacca di compressione

Grazie alle sue dimensioni spaziose di 2,35 m di lunghezza, questo modello è particolarmente adatto alle persone più alte. Morbido e accogliente assicura sempre un sonno confortevole e può essere utilizzato sia all'aperto che al chiuso dalla primavera all'autunno (3 stagioni). In caso di basse temperature, il cappuccio può essere chiuso con una zip, mentre il comodo cuscino integrato evita di dover portare con sé un cuscino separato. Con un peso inferiore a 2 kg e la sacca di compressione inclusa, il sacco a pelo è caratterizzato da dimensioni particolarmente compatte che lo rendono facile da trasportare.

CARATTERISTICHE:

- Grande sacco a pelo rettangolare per persone alte
- Reversibile
- Struttura a 2 strati sul lato superiore - struttura a 1 strato sul lato inferiore
- Imbottitura molto morbida
- Utilizzabile dalla primavera all'inizio dell'inverno (3 stagioni)
- Cappuccio staccabile (zip)
- Può essere utilizzato come coperta quando è aperto
- Cuscino integrato
- Cerniera: YKK a 2 vie - Autolock - forma a L
- Senza PFC
- Con sacca di compressione



2-way zipper



Carry bag

PELICAN XL

Art. 0428004N.L
Art. 0428004N.R

€ 71,50



-10°C | +2°C
+6°C | +20°C

Sacchetto a coperta XL molto grande per tanta libertà nel movimento mentre si dorme.

CARATTERISTICHE:

- Cerniera a doppia direzione
- Abbinabile dx-sx
- Copricerniera
- Sacca custodia
- Sacco letto 2 stagioni

- ✂ 200 x 90 cm
- 📏 Ø 25 x 42 cm
- 📖 1,77 kg
- 📄 1
- 🧶 Soft Polycotton
- 🧶 Ripstop Polyester
- 🛏 PES Hollowfibre 250 g/m²



2-way zipper



Carry bag

HUSKY 300

Art. 0428021N

€ 103,50

-10°C | +2°C
+6°C | +20°C

Sacchetto a coperta, con interno in caldissima flannela di cotone.

- ✂ 200 x 90 cm
- 📏 Ø 26 x 48 cm
- 📖 2,20 kg
- 📄 2
- 🧶 Flannel
- 🧶 Ripstop Polyester
- 🛏 2x 150 g/m² PES Hollowfibre

LINEAR RECTANGULAR

Art. 0428140N

€ 27,90

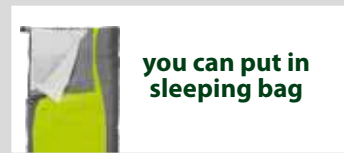

you can put in sleeping bag



Saccolenzuolo rettangolare in cotone con tasca per cuscino.

- ✂ 230 x 80 cm
- 📖 300 g
- 🧶 100% Cotton



INDIAN

Art. 0428033N

€ 37,90

- ✂ 200 x 150 cm
- 📏 Ø 18 x 35 cm
- 📖 750 g
- 🧶 Fleece 100% Polyester



Confortevole coperta in pile realizzata al 100% in morbidissimo tessuto di poliestere.



2-way zipper

Carry bag

LAGUNA LITE

Art. 0428003N

€ 40,50

+10°C / +25°C

- 185+25 x 75 cm
- Ø 14 x 24,5 cm
- 720 g
- 1
- Technical Cotton
- 190T Polyester
- 80 g/m² - Silk-like fiber

Sacchetto a coperta estivo ed ultraleggero. Completo di pratico cappuccio.



2-way zipper

Carry bag

ARGOS

Art. 0428014N

€ 103,50

-10°C / 0°C / +5°C

- 200+35 x 90 cm
- Ø 12 x 38 cm
- 1,5 kg
- 1
- Flannel
- Ripstop Polyester
- 100% PES 200 g/m²

Sacchetto XL a coperta ultraleggero con morbidissima imbottitura Feathersoft.





ALVEOMAT

Termomaterassini autogonfianti con telo in poliesteres antisdruciuolo, di estrema comodità ed ottima isolamento. Sono inclusi un set di riparazione e una sacca custodia.

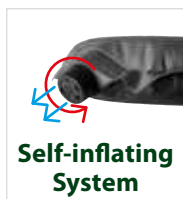

Self-inflating System



5 cm

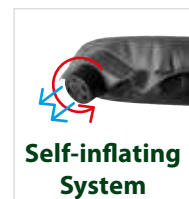

Self-inflating System



7 cm

ALVEOMAT 5

Art. 0412038N

€ 89,90

198 x 63 x 5 cm

70 x Ø 15 cm

2,15 kg

100% Polyester

ALVEOMAT 7 COMFORT

Art. 0412040N

€ 126,90

198 x 76 x 7 cm

74 x Ø 19 cm

3,90 kg

100% Polyester

ALVEOBED

I materassi ad aria Alveobed sono ideali compagni di viaggio durante attività Outdoor di ogni genere. Sacca custodia inclusa.

CARATTERISTICHE:

- Facile da usare
 - Dimensioni d'imballo salvaspazio
 - Resistente alle temperature
 - Robusto e resistente
 - Con pratica valvola Boston (Alveo Single, Alveo Double)
- * sgonfio



ALVEOBED SINGLE

Art. 0412027N

€ 50,90

220 x 75 cm*

Ø 12,5 x 28 cm

1,45 kg

100% Polyester 190T/75D PVC Coating

ALVEOBED DOUBLE

Art. 0412028N

€ 97,90

220 x 142 cm*

Ø 25 x 36 cm

3,3 kg

100% Polyester 190T/75D PVC Coating



BOSTON VALVE



INTEGRATED CUSHION





**AIR
PUMP
SYSTEM**

MOFLATE

Art. 0412022N

€ 57,90

 200 x 70 x H8 cm

 27 x Ø 11,5 cm

 900 g

 40D Nylon / DPU

Materassino gonfiabile ultraleggero e super-compatto con pompa di gonfiaggio integrata. Ideale per tutte le attività outdoor e camping che richiedono un pernottamento. Ottima isolazione dall'umidità del terreno grazie alla speciale conformazione delle camere d'aria. Completo di sacca custodia.



ALVEOBED SINGLE IP

Art. 0412039N

€ 59,90

 220 x 75 cm*

 Ø 12,5 x 28 cm

 1,45 kg

 100% PES / PVC Coating

SIX MAT

Art. 0412036N

€ 33,50

 185 x 70 cm*

 Ø 18 x 32 cm

 780 g

 100% Polyester

Materassino ultra leggero in poliestere antisdrucciolo di alta qualità. Costruzione a sei tubi. Con sacchetto custodia. * sgonfio

ALVEOBED PILLOW

Art. 0412029N

€ 14,50

 60 x 40 cm

 Ø 5 x 21 cm

 200 g

 100% Polyester 190T/75D TPU Coating

Cuscino Outdoor di alta qualità. Con borsa custodia.



**AIR
PUMP
SYSTEM**



SOMNI 3D

NEW
2023



Extra
Comfort

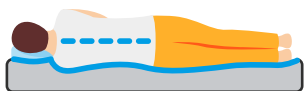

Front

Back



Front

Back



SELF-INFLATING SYSTEM



INFLATION

With
Foam cut

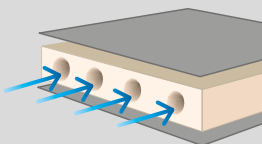

DEFLATION

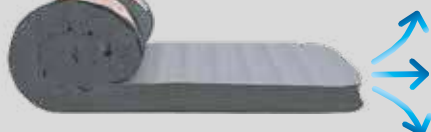

SOMNI 3D SINGLE

Art. 0432085N

€ 149,90

✂ 200 x 76 x 10 cm

📏 Ø 19 x 79 cm

📖 3,2 kg

🔲 190T 75D Polyester

SOMNI 3D DOUBLE

Art. 0432089N

€ 209,90

✂ 200 x 132 x 10 cm

📏 Ø 27 x 68 cm

📖 5,7 kg

🔲 190T 75D Polyester

Materasso autogonfiante di nuova concezione. Molto confortevole, con un eccezionale rapporto tra peso complessivo e materiale isolante ottenuto mediante l'utilizzo di uno strato continuo di schiuma isolante in cui scorrono i flussi d'aria orizzontali. Realizzato in tessuto in poliestere con rivestimento superiore ad effetto peach skin. Ideale per un riposo ottimale. Grazie ad una particolare valvola bidirezionale, che al bisogno blocca o permette il flusso d'aria, il materasso si gonfia autonomamente. Per sgonfiarlo è sufficiente arrotolarlo chiudendo la valvola a fine operazione, sarà quindi poi riponibile occupando poco spazio. Completo di sacca custodia. Disponibile in 2 misure.



FLAIR

I nostri materassini ad aria Flair sono realizzati con una soffice superficie in velluto e di resistente PVC. Dispongono di grosse valvole per un rapido gonfiaggio e sgonfiaggio. Ideali come letto per ospiti o per il campeggio.
* sgonfio



SINGLE GREY



SINGLE BLUE



DOUBLE GREY



DOUBLE BLUE



JUMBO

included only
for Jumbo





MAT PLUG BOSTON

Art. 0434007C
PACK 2X



€ 7,50

Tappi di ricambio per materassini in PVC fioccato.

					
SINGLE BLUE	Art. 0432080N.C30	191 x 73 x 22 cm*	1,68 kg	100% PVC	€ 28,90
DOUBLE BLUE	Art. 0432082N.C30	191 x 137 x 22 cm*	2,96 kg	100% PVC	€ 46,50
SINGLE GREY	Art. 0432080N.C06	191 x 73 x 22 cm*	1,68 kg	100% PVC	€ 28,90
DOUBLE GREY	Art. 0432082N.C06	191 x 137 x 22 cm*	2,96 kg	100% PVC	€ 46,50
JUMBO	Art. 0432086N	203 x 157 x 38 cm*	4,96 kg	100% PVC	€ 126,50



INFO MATERASSINI AD ARIA

I materassini ad aria, conosciuti anche come materassini gonfiabili, sono una comoda opportunità di riposo a basso costo per tutti i campeggiatori. Sono adattabili individualmente, proteggono tutto il corpo e consentono un sonno rilassato. Nell'assortimento Brunner sono presenti due tipi di materassini (materassini in PVC con superficie vellutata e materassini in cotone gommato). Entrambi i modelli sono disponibili in varie misure per soddisfare sia adulti che bambini, ma anche le coppie. Gli svantaggi dei materassini ad aria sono il loro peso, la dimensione d'imballo ed il fatto che prima dell'uso debbano essere gonfiati (non dimenticare la pompa d'aria). I materassini ad aria con superficie vellutata sono adatti anche per casa come letto d'emergenza per amici e parenti. Da considerare che i materassini ad aria non sono adatti all'utilizzo in acqua. Per questi casi esistono semplici materassini in PVC.



WHISPER

Art. 0436003N

€ 27,90

- 2x 2000 CC
- 12 x 22 x 45 cm
- 800 g

Pompa doppia azione.
Con set adattatori.



WHISPER ALU

Art. 0436002N

€ 42,90

- 1x 3000 CC
- 10 x 22 x 54 cm
- 1,2 kg

Pompa aria con pistone in alluminio e
set adattatori.



SUSSURRO

Art. 0436006N

€ 17,50

- 5000 CC
- 650 g

Gonfiatore a mantice con robuste basi antiscivolo in materiale plastico. Completo di adattatori.



INFLATOR

Art. 0436010N

€ 20,90

- 12 x 10 x H11,5 cm
- 230 g
- 12V DC
- 75W

l/min 20 l/min

Gonfiatore e sgonfiatore elettrico 12V con
interruttore ON/OFF completo di 3 adattatori.



TEMPEST RG USB

Art. 0436016N

€ 43,90

- 8 x 7,5 x 10,5 cm
- 280 g
- RG
- 38 W

l/min 270 l/min

Potente pompa 5V con interruttore ON-OFF.
Completa di adattatore USBC. Con borsa.

MEMO

Cuscino compatto in speciale schiuma ad alta densità Memory Foam.



**CORRECT
SLEEPING
POSITION**



MEMO TRAVEL

Art. 0434009N

€ 32,50

 37 x 28 x 10 cm

 460 g

 100% Polyester + Aloe Vera



MEMO CAMPER

Art. 0434010N

€ 46,50

 50 x 30 x 10/7 cm

 700 g

 75% Cotton 25% PES + Aloe Vera



COLORS



MORGAN

Art. 0434015N

€ 9,40

 47,5 x 32,5 x H11,5 cm

 120 g

 100% PVC



BACK

NANNA

Art. 0434016N

€ 13,90

 41 x 33 cm

 150 g

 30% Cotton 70% Polyester



**REMOVABLE and
WASHABLE COVER**



Cuscino poggiatesta gonfiabile con superficie vellutata piacevole al tatto.

Cuscino poggiatesta gonfiabile con fodera in tessuto misto cotone piacevole al tatto.



MAT

COLLECTION



SUNRAY

Art. 0412001C

€ 13,90

180 x 50 x 0,7 cm

37 x 50 x 3,5 cm

210 g

100% PE

Materassino bistrato pieghevole in 100% PE. Entrambi i lati lisci.



ROAMAT

Art. 0412003N

€ 20,90

180 x 50 x 1,2 cm

Ø 17 x 50 cm

390 g

100% EVA

Materassino bistrato in EVA a cellule chiuse.



KOALA

Art. 0412006N

€ 13,90

180 x 50 x 0,7 cm

Ø 13 x 50 cm

190 g

100% EVA

Materassino monostrato in EVA a cellule chiuse. Liscio su entrambi i lati.



ALU-MAT

Art. 0412017C

€ 16,50

180 x 50 x 0,7 cm

Ø 14 x 50 cm

190 g

100% PE

PACK 1X

Materassino monostrato con film alluminizzato e goffatura sul lato superiore. Leggero e compatto.

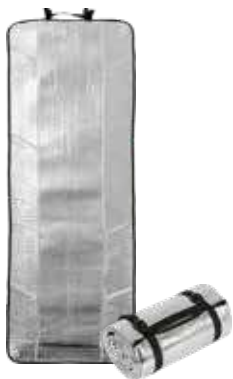

ALU TRAMP

Art. 0412009N

€ 11,50

190 x 55 x 0,3 cm

Ø 14 x 29 cm

138 g

PE / Alu

Stuoia isolante impermeabile con imbottitura.



GRENADA

Art. 0412030N

€ 48,90

183 x 54 x 3 cm

28 x 54 x 18 cm

650 g

30% Cotton 70% Polyester 100% PVC

Materassino da spiaggia imbottito e foderato.



BONITA

Art. 0412031N

€ 40,50

140 x 50 x 2 cm

50 x 23 x 11 cm

840 g

100% Polyester Oxford

Materassino con rivestimento in resistente tessuto antistrucchiolo realizzato in Polyester Oxford.



TORTUGA

Art. 0412023N

€ 36,90

193/180 x 60 cm

Ø 18 x 60 cm

400 g

100% Polyester + 100% PE

Comodo materassino da spiaggia in tessuto leggermente imbottito.



PRAIA

Art. 0412025N

€ 9,90

180 x 85 cm

Ø 5 x 85 cm

320 g

100% PP

Stuoia per spiaggia realizzata in resistente tessuto polipropilenico.



OASIS ALU

Art. 0412019N

€ 17,50

180 x 80 cm

Ø 6 x 80 cm

480 g

Natural Fiber / Alu Foil

Stuoia spiaggia in fibra vegetale, alluminizzata su un lato.



CAYO

Art. 0412018N

€ 18,90



180 x 200 cm

37 x 7 x 28 cm

720 g

100% PP

Stuoia spiaggia realizzata in tessuto PP flessibile, resistente e idrorepellente. Design moderno. Pratica da riporre e trasportare.



PICNIC PLAID

Art. 0428052N

€ 36,90



200 x 150 cm

38 x 8 x 26 cm

870 g

100% Polyester

Coperta picnic leggermente imbottita.



ASSORTED

ALFRESCO

Art. 0428054N

€ 36,90

200 x 150 cm

30 x 15 x 21 cm

500 g

100% Polyester Fleece / Peva

Coperta da picnic con superficie soffice e morbida in resistente fibra sintetica idrorepellente. Il lato inferiore ha un rivestimento impermeabile. Con maniglia per il trasporto.



ASSORTED

TJAGO

Art. 0428061N

€ 34,90



145 x 200 cm

34 x 8 x 18,5 cm

500 gr

100% Polyester / PEVA

Coperta picnic arrotolabile realizzata in resistente tessuto di poliestere e lato inferiore idrorepellente.





INFO

IL LETTINO DA CAMPO

I lettini da campo danno la possibilità di dormire in modo comodo e sicuro, ben rialzati dal terreno. Soprattutto in caso di maltempo si è protetti dal bagnato e dall'umidità. Inoltre non si è a contatto con fastidiosi insetti. A seconda del modello di lettino esiste la possibilità di stivare attrezzatura sotto al telo per dormire. Come per ogni acquisto di attrezzatura, sono molte le considerazioni da fare nella scelta di un lettino da campo. Ogni modello presente nel nostro catalogo ha dei vantaggi e svantaggi. E' soprattutto importante ragionare sul mezzo che verrà utilizzato per trasportare il lettino da campo: alcuni diventano molto piccoli perchè si possono scomporre o ripiegare, altri sono solo pieghevoli, con misure meno compatte, ma solitamente più confortevoli.



OUTDOOR COT

Art. 0410032N.C30 € 117,50

 190 x 64/72 x H43 cm

 95 x 21 x H14 cm

 4,8 kg



Lettino da campo con struttura pieghevole e smontabile in alluminio.

NEW
2023



OUTDOOR COT XL2

Art. 0410045N € 139,90

 210 x 80 x H50 cm

 103 x 20 x 12 cm

 6,5 kg



Lettino da campo di ampie dimensioni. Telaio in alluminio anodizzato.



OUTDOOR COT AUTOMATIC

Art. 0410044N € 114,50

 191 x 66 x H44 cm

 105 x 15 x H15 cm

 8,9 kg



Lettino da campo robusto con struttura pieghevole appositamente progettata per essere aperta e ripiegata in un istante. Comoda tela in resistente tessuto di poliestere con poggiatesta integrato e imbottito. Di dimensioni compatte quando ripiegato. Con pratica borsa per il trasporto.



BELHAM

Amaca da viaggio realizzata in tessuto sintetico ultraleggero e super resistente. Dotata di ampia superficie di sdraio ed una capacità di carico massima di 300 kg. Molto compatta da trasportare mediante una pratica sacca custodia inclusa nella fornitura che funge anche da piccola tasca per riporre gli occhiali da sole, il cellulare, gli spiccioli, ecc. Perfetta per outdoor, camping, moto e cicloturismo. Disponibile in versione singola e doppia. Accessori di fissaggio inclusi.



BELHAM SINGLE

Art. 0414005N

€ 38,50

- 270 x 140 cm
- 22 x 14 x 5 cm
- 500 g
- 300 kg



2X Carabiners



2X Looped Straps 6 Rings



280 cm



210T Parachute Fabric



BELHAM DOUBLE

Art. 0414006N

€ 46,50

- 300 x 200 cm
- 24 x 16 x 6 cm
- 710 g
- 300 kg



VOYAGER

Art. 0414009N

€ 28,90

- (52,5+225+52,5) x 147 cm
- 21 x Ø 7 cm
- 380 g
- 100 kg
- Nylon 100% PA



Amaca ultraleggera di dimensioni molto compatte.



SAMBA



Metal reinforced knot

Durable support ropes



Bright colours Soft feel

SAMBA

Art. 0414016N.C28

€ 57,50

WITH BAG



(65+210+65) x 140 cm

34 x Ø 18 cm

1,7 kg

100 kg

Polycotton

Amaca tradizionale in stile brasiliano.

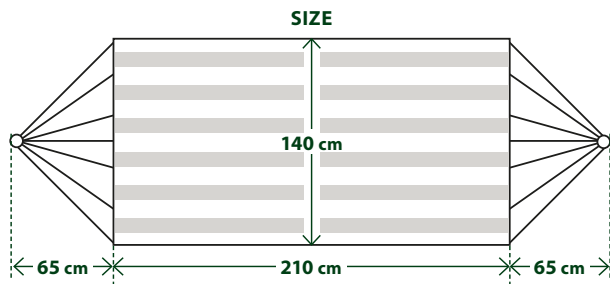

SAMBA DUO

Art. 0414017N.C28

€ 79,90

WITH BAG



(55+255+55) x 165 cm

40 x Ø 15 cm

2,1 kg

160 kg

Polycotton

Amaca tradizionale in stile brasiliano.

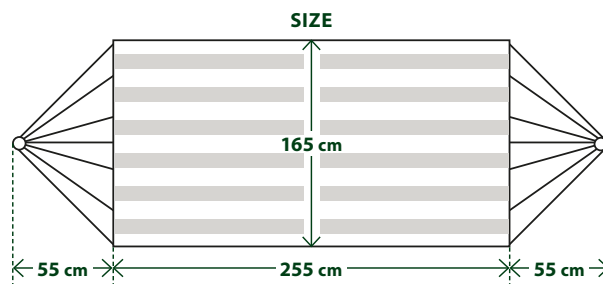

HAMRO

Art. 0414022N

€ 13,50

300 cm x 2

225 gr x 2

130 kg

Set 2 funi per amache.

JARDIM



Metal reinforced knot

Durable support ropes



Bright colours Soft feel

WITH BAG



JARDIM

Art. 0414018N

€ 53,50



(40+210+40) x 100 cm

85 x Ø 10 cm

1,6 kg

100 kg

Polycotton

Comoda amaca con pali divaricatori in legno.

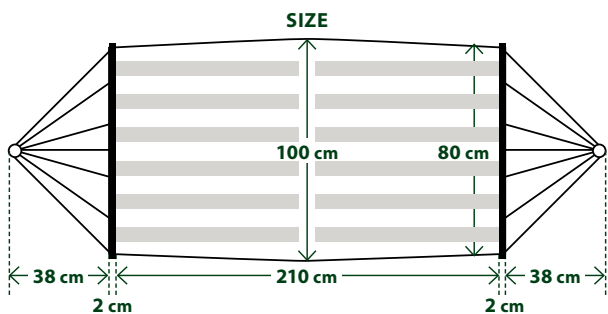

JARDIM DUO

Art. 0414019N.C28

€ 92,50



(47+206+47) x 160 cm

122 x Ø 12 cm

2,6 kg

130 kg

Polycotton

Comoda amaca con pali divaricatori in legno.

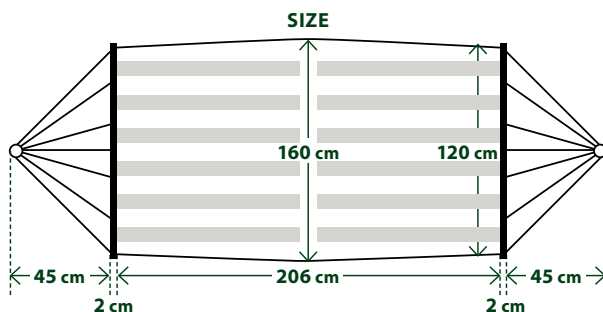



TRAVEL ACCESSORIES



**BORSE VIAGGIO
NECESSAIRE
ACCESSORI VIAGGIO**

GETAWAY



55 cm



GETAWAY

Art. 9003043N

€ 144,50

40 x 55 x 25 cm

45 l

420D Polyester/PVC

2,8 kg



Borsa da viaggio di dimensioni compatte con funzione trolley. Ideale per viaggi di 2-3 giorni.

CARATTERISTICHE:

- Tessuto esterno idrorepellente
- Ruote angolari di alta qualità
- Maniglione telescopico a scomparsa con manopola di bloccaggio
- 2 maniglie di trasporto
- Cerniere di ottima qualità
- Cinghie interne di fissaggio bagaglio
- Ampia tasca frontale

AIR FORCE



73 cm



AIR FORCE

Art. 9003045N

€ 229,90

38 x 73 x 43 cm

120 l

420D Polyester/PVC

4,5 kg



Spazioso borsonese da viaggio con ruote che soddisfa tutte le aspettative del viaggiatore sportivo.

CARATTERISTICHE:

- Tessuto esterno idrorepellente
- 2 scomparti principali molto spaziosi
- Struttura stabile e robusta
- Scomparto superiore con accesso diretto e tasca laterale
- Pratiche maniglie per il trasporto
- Maniglione telescopico a scomparsa con manopola di bloccaggio
- Cinghie interne di fissaggio bagaglio
- Tasca a rete interna
- Cinghie di compressione esterne
- Ruote angolari di alta qualità
- Cerniere di prima scelta



ATREA

Art. 0712090N

€ 9,50

7,4 x 4 x H22,3 cm

160 g

Comoda bilancia portatile pesa bombole o bagagli, con metro a nastro incorporato. Da portare sempre con sé in viaggio per essere più sicuri del peso trasportato evitando quindi spiacevoli sorprese. Pesa fino a 34 kg. Piccola, leggera e robusta.



EXPLORE DUFFLE

Art. 9003047N

€ 82,90

Ø 40 x 68 cm

85 l

Tarpaulin 100% PVC

1,8 kg



Borsa viaggio impermeabile in Tarpaulin resistente all'acqua e allo sporco.



COM-PACK TRAVELBAG

Art. 9003055N.C03

€ 26,50

29 x 56 x 24 cm

28 x 18 cm

35 l

Nylon Ripstop

300 g



Borsa multiuso completa di maniglie e cinghia a tracolla.



MONEY BELT

Art. 9004031N.C01

€ 13,50

31 x 14 cm

150 g

600D Polyester 100% Polyester

Due tasche esterne cernierate. Cintura regolabile. Dorso in tessuto morbido e piacevole al tatto.

SOS NG

Art. 0428060N

€ 3,50

210 x 135 cm

43 g

Coperta di emergenza in alluminio.



RAINMAN

Art. 8410011N

€ 11,90

203 x 127 cm

200 g

100% PVC

Poncho impermeabile. Colori assortiti: blu, verde.





SHUTBAGS

Art. 0202204N

€ 9,90

100% PVC

PACK 3X

Protezione ermetica da acqua e polvere per oggetti di valore. Con cordoncino per il trasporto.
 1x 12,5 x 17,5 cm
 1x 17,5 x 25 cm
 1x 26,5 x 34 cm

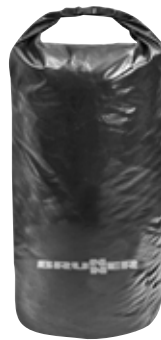
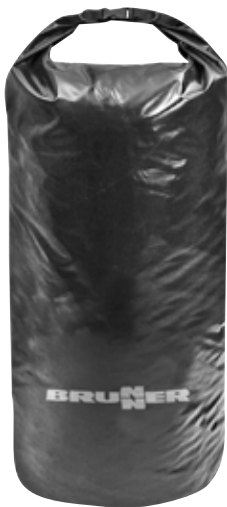

DRYZAK



DRYZAK M	Art. 0202229N	36 l	Polyester / PVC	€ 31,90
DRYZAK L	Art. 0202230N	62 l	Polyester / PVC	€ 34,50



Sacca impermeabile con cuciture saldate e pratica chiusura ad arrotolamento con fibbia.



POOL ROUND

Art. 0812010N

€ 32,50 16L

V 16 l

Ø 33 x 25 cm

400 g

100% PVC



POOL

Art. 0812011N

€ 28,90 12L

V 12 l

29 x 29 x 16 cm

280 g

Polyester / PVC



Lavello pieghevole con bordo rinforzato.

Secchio rotondo pieghevole con bordi rinforzati e pratico organizer ad aggancio.



BEAUTY CASE

COLLECTION



BODY&SOUL

Art. 9004015N.C73

€ 25,50

25,5 x 12 x 48,5 cm

25,5 x 12 x 15 cm

350 g

PVC / Polyester

Pratico nécessaire da viaggio realizzato in resistente tessuto a doppia spalmatura.



HOLIDAY

Art. 9004016N.C73

€ 34,90

26 x 14 x 37 cm

25 x 13 x 28 cm

415 g

PVC / Polyester

Il beauty-case imbottito offre ampio spazio per una lunga vacanza.



WASH BAG

Art. 9004018N.C73

€ 27,90

25,5 x 44 cm

25,5 x 16 cm

210 g

PVC / Polyester

Beauty-case con specchietto interno. Gancio in metallo. Vari scomparti e tasche con cerniera interni. Chiusura a fibbia.



WC-MASK

Art. 0402031N

€ 5,90



Copripiedile igienico per WC in carta dissolvibile. Confezione da 20 pezzi.



Bio degradable
dissolvable in water



256 Fori pollice



TROPICANA

Art. 0202087N

€ 44,50

Ø 60 x 900 x H250 cm

600 g

100% PES



Zanzariera da viaggio con ventaglio di tensione e custodia. Adatta per letti doppi.

POP UP SINGLE

Art. 0202089N

€ 33,50

Ø 50 x 900 x H250 cm

385 g

100% PES

Zanzariera da viaggio con anello di tensione pieghevole (sistema POP UP ad apertura automatica).

POP UP DOUBLE

Art. 0202090N

€ 40,50

Ø 50 x 1500 x H250 cm

720 g

100% PES



CITRONELLA CANDLE S

Art. 0205055N

€ 4,90

Ø 6,5 x H6 cm

12 g

CITRONELLA CANDLE M

Art. 0205056N

€ 5,90

Ø 10 x H8,5 cm

18 g

TEA LIGHT

Art. 0205061C

€ 3,50

PACK 15X

ESSENCE Citronella

MOSSY BOX

Art. 0205011C

€ 13,50

Ø 130 x H50 mm

PACK 1X

Candela alla citronella avvolta in elegante contenitore di melamina.

CARATTERISTICHE:

- Contiene olio di citronella

Candele per lampade outdoor alla citronella.

Contenitore per zampironi in materiale plastico termoresistente. Spirali escluse.



OUTDOOR FURNITURE

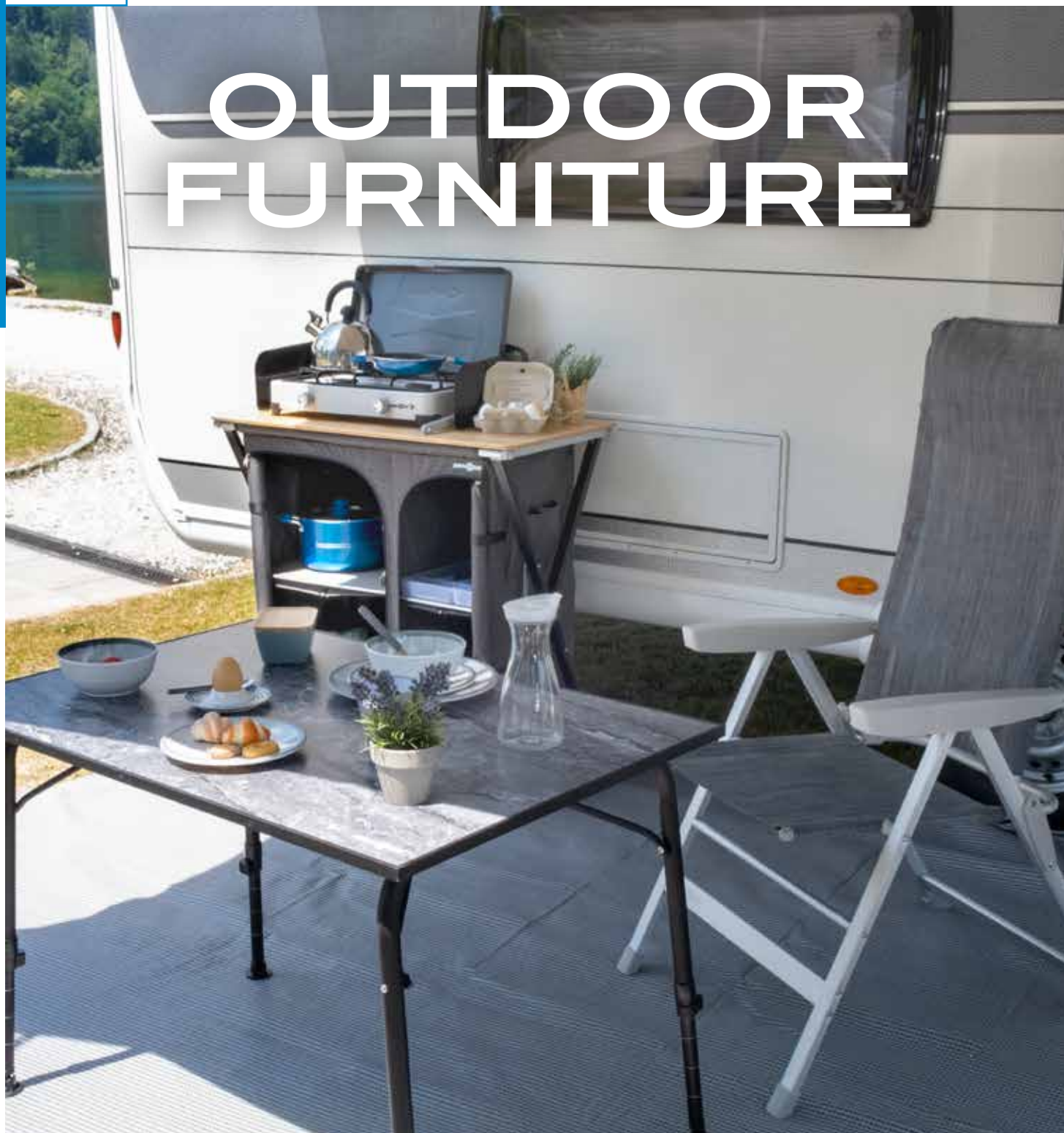

**SEDIE E LETTINI
TAVOLI
ARMADI E MOBILETTI CUCINA**

CHAIR COLLECTION

FOLDING OUTDOOR CHAIRS

La nostra gamma di sedie comprende una varietà di modelli che hanno funzioni diverse a seconda delle dimensioni, del peso, delle dimensioni dell'imballaggio o del comfort. Quando si sceglie una sedia da tavolo, si dovrebbe prevedere uno schienale verticale, mentre una sedia Outdoor pura deve essere leggera con una piccola dimensione di imballaggio. D'altra parte, una sedia relax deve avere una seduta più ampia e uno schienale comodamente reclinabile. Per facilitare la scelta della sedia giusta, abbiamo elaborato una panoramica che mostra tutte le caratteristiche importanti dei modelli di sedie Brunner ed il loro uso ideale.

SKYE RT

BLACK



NEW
2023

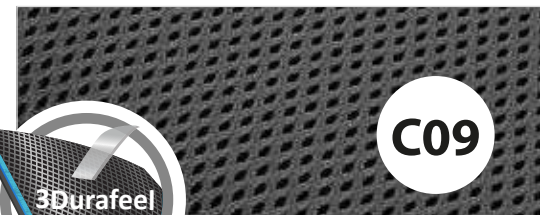

C09

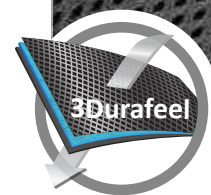



SKYE RT

Art. 0404060N.C09

€ 87,90

 43 x 46 x H46/112 cm

 108 x 60 x 10 cm

 4,5 kg





OPTIONAL

SKYE RT STANDALONE FOOTREST

Art. 0404066N.C09

€ 39,90

 61 x 49 x H49 cm

 67 x 60 x 8 cm

 2,1 kg

Poggiapiedi autoportante a 4 gambe con copertura 3D traspirante con telaio in alluminio verniciato a polvere.

Sedia Camping pieghevole di alta qualità dotata di uno schienale alto regolabile a 7 posizioni ed una classica struttura ad U che garantisce un appoggio sicuro anche su pavimenti morbidi. Il telaio compatto e pieghevole è realizzato in tubolare di alluminio verniciato a polvere che, in combinazione con la resistente seduta in tessuto 3D, garantisce una seduta stabile e assai confortevole.

CARATTERISTICHE:

- Telaio pieghevole in alluminio verniciato a polvere
- Seduta in tessuto 3Durafeel
- Schienale regolabile a 7 posizioni con poggiatesta integrato
- Eleganti braccioli in plastica resistente
- Elevato comfort di seduta
- Confezione molto compatta
- Poggiagambe fornibile come optional

**C09****3Durafeel**

SKYE

BLACK



SKYE 3D

Art. 0404063N.C09

€ 99,90

SKYE 3D COMPACT

Art. 0404088N.C09

€ 69,90

SKYE ARIA

Art. 0404069N.C09

€ 118,90

47 x 41 x H47/122 cm

60,5 x 106,5 x 12 cm

4,3 kg

65 x 57 x H40/95 cm

58 x 85 x 9 cm

3,3 kg

69 x 62 x H109 cm

93 x 62 x 14 cm

6,6 kg

Sedia da esterno pieghevole a 4 gambe con schienale reclinabile a 6 posizioni.

CARATTERISTICHE:

- Telaio in alluminio
- Tessuto 3D imbottito
- Schienale regolabile a 6 posizioni
- Braccioli in robusto materiale plastico
- Possibilità di collegare un poggiatesta
- Compatta e facile da trasportare quando ripiegata

Sedia pieghevole salvaspazio in alluminio con schienale fisso e struttura ad U. Schienale basso. Rivestimento in confortevole tessuto 3D.

Sedia pieghevole per esterni con struttura in alluminio superleggera. Schienale e seduta sono realizzati in materiale termoplastico resistente alle intemperie. Il design ben studiato e innovativo con telo amovibile di serie, rende questa sedia un accessorio elegante e confortevole sia per interni che per esterni.

OPTIONAL

SKYE 3D FOOTREST

Art. 0404064N.C09

€ 37,90

47 x 72 x H51/43 cm

47 x 72 x 6 cm

1 kg

Poggiatesta pieghevole per sedia Skye 3D.

CARATTERISTICHE:

- Struttura in alluminio
- Telo portante in tessuto 3D
- Compatto e comodo da trasportare quando ripiegato



Thermoplastic



SKYE

DARK GREY & LIGHT GREY

C67

C53

Syntex
Plus

alu

12Kg



NOT AVAILABLE
IN SOME
EU COUNTRIES

SKYE

Art. 0404063N

€ 93,90



46,5 x 42 x H48/124 cm

108 x 60 x 11 cm

4,5 kg

Sedia pieghevole a 4 gambe con schienale reclinabile a 6 posizioni.

CARATTERISTICHE:

- Struttura in alluminio
- Telo portante in Syntex Plus
- Schienale reclinabile a 6 posizioni
- Braccioli in resistente materiale plastico
- Possibilità di collegare un poggiatesta
- Compatta e comoda da trasportare quando ripiegata



6 Positions

SWAN SKYE

Art. 0404067N.C67

€ 119,90

90 x 69 x 113 cm

98 x 16 x 69 cm

7,5 kg

La sedia Swan Skye è la miglior prova che il campeggio può essere davvero confortevole. Essendo un vero e proprio prodotto outdoor la sua seduta permette di scegliere qualsiasi posizione rilassata si desidera.

CARATTERISTICHE GENERALI:

- Telaio in acciaio verniciato a polvere
- Telo portante in Syntex Plus
- Aperta e pronta all'uso in pochissimi secondi
- Facile da trasportare e compatta

OPTIONAL

SKYE FOOTREST

Art. 0404064N

€ 31,90

47 x 72 x H51/43 cm

47 x 72 x 6 cm

1 kg

Poggiatesta pieghevole.

CARATTERISTICHE:

- Struttura in alluminio
- Telo portante in Syntex Plus
- Compatto e comodo da trasportare quando ripiegato



Extra
Comfort



CHAIR 4 ALL ERGONOMIC CONCEPT

DI QUALI DIMENSIONI DI SEDIA AVETE BISOGNO?

Sei seduto comodamente? La dimensione della sedia riveste sempre un ruolo importante!

Molti di noi passano molte ore in posizione seduta durante il giorno. Al lavoro, a casa, a tavola o mentre ci rilassiamo: dovremmo fare attenzione a star seduti comodamente, per evitare tensioni e per aumentare il nostro benessere.

Fondamentalmente, non si può formulare uno statement generale sulla giusta posizione di seduta. La taglia del corpo, le proporzioni del corpo e anche l'altezza del tavolo giocano un ruolo importante.

Ci sono quindi molte ragioni che ci fanno riflettere sulla giusta dimensione di una sedia. Non solo il comfort, la meccanica e il design attraente della vostra sedia Outdoor, ma anche una postura ergonomica dovrebbero essere un importante criterio di selezione.

Grazie alle nuove taglie sviluppate, la collezione di sedie Aravel / Rebel Pro certamente dispone della sedia giusta per la vostra taglia. Molto importante: la giusta altezza della seduta influisce positivamente sul benessere!

Fate attenzione che i vostri piedi siano comodamente appoggiati al pavimento e che gli avambracci formino un angolo retto con la parte superiore del braccio. Quindi la sedia giusta non solo deve piacere, ma deve anche essere davvero la scelta giusta per te e per le tue misure corporee.

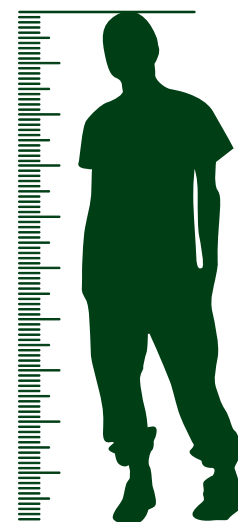
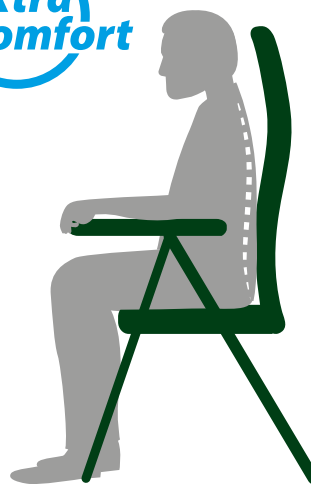

originaldesign

INFO

3DURAFEEL PRO REBEL / ARAVEL

Il tessuto di rivestimento 3Durafeel Pro è un tessuto molto speciale utilizzato nelle nostre collezioni di sedie Rebel e Aravel. Grazie alla sua permeabilità all'aria e alla delicatezza sulla pelle, trasforma il comfort in una meravigliosa esperienza di seduta per ore di relax all'aperto. 3Durafeel Pro si asciuga incredibilmente in fretta anche dopo una leggera pioggia e irradia una piacevole atmosfera di benessere sulla veranda, sulla terrazza o sul balcone. E questo in modo affidabile per molti anni.

Infatti, 3Durafeel Pro è resistente allo strappo e all'abrasione, traspirante, resistente alla luce e repellente allo sporco. Costruzione monostrato (trama speciale).

3DURAFEEL ARAVEL / SKYE

Il tessuto di rivestimento 3Durafeel è un tessuto molto speciale utilizzato nelle nostre collezioni di sedie Aravel e Skye. Grazie alla sua permeabilità all'aria e alla delicatezza sulla pelle, trasforma il comfort in una meravigliosa esperienza di seduta per ore di relax all'aperto. 3Durafeel si asciuga incredibilmente in fretta anche dopo una leggera pioggia e irradia una piacevole atmosfera di benessere sulla veranda, sulla terrazza o sul balcone. E questo in modo affidabile per molti anni. Infatti, 3Durafeel è resistente allo strappo e all'abrasione, traspirante, resistente alla luce e repellente allo sporco. Costruzione a tre strati.



ARAVEL VITACHIC

ANTRACITE

C69

3Durafeel
Pro

ARAVEL VITACHIC S

Art. 0404065N.C69S

€ 132,90

41 x 44 x 46,5/116 cm

106,5 x 59,5 x 10 cm

5,2 kg

ARAVEL VITACHIC M

Art. 0404065N.C69M

€ 139,90

47 x 44 x 48/121 cm

114 x 64,5 x 10 cm

5,3 kg

ARAVEL VITACHIC L

Art. 0404065N.C69L

€ 149,90

49 x 44 x 50/126 cm

117,5 x 67,5 x 10 cm

5,58 kg

La sedia pieghevole Aravel Vitachic è realizzata con uno schienale alto regolabile (7 posizioni) e con la nostra speciale imbottitura 3Durafeel Pro che offre un massimo di comfort durante tutte le stagioni. Dotata di un telaio ultraleggero pieghevole in alluminio che ne consente un rapido e semplice processo di apertura e ripiegamento. Disponibile nelle versioni S-M-L.



ARAVEL VITACHIC STOOL

Art. 0404078N.C69

€ 37,90

27 x 40 x H45 cm

42 x 60 x 4 cm

1,2 kg

Sgabello pieghevole con struttura in alluminio e seduta realizzata in tessuto speciale 3Durafeel PRO.



OPTIONAL

ARAVEL VITACHIC STANDALONE

Art. 0404073N.C69

€ 57,90

61 x 49 x H49 cm

67 x 60 x 8 cm

2,1 kg

Poggiatesta indipendente con struttura pieghevole in alluminio verniciato a polvere e rivestimento in tessuto 3Durafeel Pro di alta qualità. Utilizzabile anche come sgabello.



7 Positions

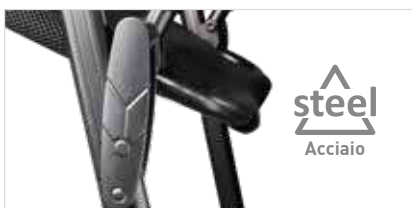



C09



ARAVEL

BLACK



S M L



Moderna sedia pieghevole a 4 gambe con schienale reclinabile a 7 posizioni.

CARATTERISTICHE:

- Struttura in profilo di alluminio ad alta portata
- Telo portante in tessuto 3D imbottito e traspirante
- Schienale ergonomico e reclinabile a 7 posizioni
- Schienale con poggiatesta imbottito integrato
- Braccioli in resistente materiale plastico
- Snodo centrale in acciaio
- Possibilità di collegare un poggiatesta
- Compatta e comoda da trasportare quando ripiegata



ARAVEL 3D S

Art. 0404065N.C09S

€ 124,90

ARAVEL 3D M

Art. 0404065N.C09M

€ 129,90

ARAVEL 3D L

Art. 0404065N.C09L

€ 139,90

41 x 44 x H46,5/116 cm

106,5 x 59,5 x 10 cm

5,2 kg

47 x 44 x H48/121 cm

114 x 64,5 x 10 cm

5,3 kg

49 x 44 x H50/126 cm

117,5 x 67,5 x 10 cm

5,58 kg



ARAVEL 3D STOOL

Art. 0404084N.C09

€ 35,90

27 x 40 x H45 cm

42 x 60 x 4 cm

1,2 kg

Sgabello pieghevole Aravel 3D.

CARATTERISTICHE:

- Struttura in alluminio
- Telo portante in tessuto 3D imbottito e traspirante.
- Compatto e comodo da trasportare quando ripiegato

ARAVEL

BLACK

C09

3Durafeel



OPTIONAL

ARAVEL UNIVERSAL FOOTREST

Art. 0404079N.C09

€ 54,90

43 x 95 x H47/44 cm

43 x 95 x 7 cm

1,1 kg



Poggiagambe pieghevole universale per sedie Aravel 3D (S-M-L).

CARATTERISTICHE:

- Struttura in alluminio
- Telo portante in tessuto 3D imbottito e traspirante
- Compatto e comodo da trasportare quando ripiegato

ARAVEL 3D FOOTREST

Art. 0404099N.C09

€ 59,90

51 x 71 x H48/43 cm

51 x 71 x 6 cm

1,35 kg



Poggiagambe pieghevole per sedia Aravel 3D M.

CARATTERISTICHE:

- Struttura in alluminio
- Telo portante in tessuto 3D imbottito e traspirante
- Compatto e comodo da trasportare quando ripiegato

ARAVEL 3D STANDALONE FOOTREST

Art. 0404073N.C09

€ 56,90

61 x 49 x H49 cm

67 x 60 x 8 cm

2,1 kg



Poggiapiedi autoportante a 4 gambe con copertura FULL-3D traspirante con telaio in alluminio verniciato a polvere.

ADAPTER SET LIMBO ARAVEL

Art. 0404070N.C09

€ 8,90

MOUNTING SYSTEM
ARAVEL L



MOUNTING SYSTEM
ARAVEL S



FRESHBACK

Art. 0404005N.C06

€ 21,90

400 g

100% Microfibre Polyester



Adattatore universale per poggiambe Limbo. Permette un facile fissaggio a tutte le varianti della collezione di sedie Aravel. Set da 2 pezzi.

Comodo e pratico rivestimento in spugna per le collezioni di sedie Aravel e Rebel. Colore: grigio. Taglio perfettamente aderente. Misura: M.



C09

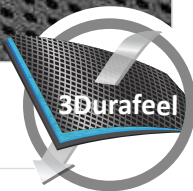

ARAVEL

BLACK

NEW 2023



ARAVEL DIRECTOR

Art. 0404080N.C09

€ 76,90

45 x 35 x 48/87,2 cm

73,5 x 51 x 13,5 cm

3,5 kg

Sedia da regista con telaio classico realizzato mediante profilo in alluminio verniciato a polvere. Ingombro ridotto grazie allo schienale ribaltabile. Seduta in tessuto 3Durafeel imbottito e traspirante. Braccioli imbottiti e rivestiti. Molto compatta e facile da riporre quando chiusa.

CARATTERISTICHE:

- Telaio salvaspazio in profilo di alluminio 22 x 22 mm
- Costruzione molto robusta
- Rivestimento realizzato in tessuto di poliestere 3Durafeel
- Schienale pieghevole per ridurre al minimo le dimensioni della confezione
- Braccioli imbottiti
- Elevato comfort di seduta
- Dimensioni di stivaggio ridotte



ARAVEL VANCHAIR

Art. 0404077N.C09

€ 79,90

48 x 37 x H41,5/82 cm

58,5 x 73,5 x 9,5 cm

3,8 kg

Sedia pieghevole super compatta con resistente telaio pieghevole in alluminio, appositamente realizzata per minibus e van. Snodo centrale in metallo. Rivestimento imbottito realizzato in comodo tessuto 3Durafeel per un alto livello di comfort.



ARAVEL DYNAFOLD

Art. 0404068N.C09

€ 99,90

51,5 x 46 x H47,5/110 cm

95 x 31 x 18 cm

6 kg



Pratica sedia pieghevole con schienale alto ad inclinazione regolabile, barre laterali e comodi braccioli per un elevato comfort abbinato a dimensioni di trasporto molto compatte. Il resistente tessuto in poliestere ed i piedini antiscivolo anteriori completano la grande funzionalità della sedia. Con sacca di trasporto.

ARAVEL

BLACK

C09

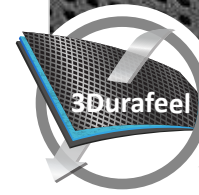

SWAN 3D

Art. 0404071N.C09

€ 259,90

50 x 49 x H48/116 cm

95 x 74 x 13,5 cm

8,0 kg

Poltrona Relax che meglio offre un grado di comfort di altissimo livello. Costruzione stabile e robusta con struttura pieghevole in alluminio. Braccioli larghi e confortevoli.

CARATTERISTICHE:

- Schienale regolabile senza scatti con leva di bloccaggio
- Aperta e pronta all'uso in pochissimi secondi
- Non necessita di premontaggio
- Facile da trasportare

NOT AVAILABLE
IN SOME
EU COUNTRIES



ARAVEL HIGH DUNA 3D

Art. 0410062N.C09

€ 199,90

198 x 64 x H48/103 cm

84 x 12 x 72 cm

8 kg

Letto di alta qualità con struttura in alluminio verniciato a polvere e pratico tettuccio parasole. Grazie alla sua ampia e alta superficie, salire e scendere è eccezionalmente facile e senza alcuna difficoltà. Inoltre, la superficie di sdraio rivestita in tessuto 3D imbottito offre un elevato grado di comfort. Il poggiatesta è regolabile a 5-posizioni. Dopo l'uso, il letto da sole può essere facilmente ripiegato, trasportato e riposto per risparmiare spazio.



ADJUSTABLE
Ø 70-85mm



OPTIONAL

CANCAGE

Art. 0404023N

€ 13,50

15 x 22 x 7,5 cm

180 g

Il portabevande Cancage garantisce un supporto sicuro a lattine e bottiglie su moltissime sedie Outdoor, da campeggio e da giardino. Il sistema di montaggio rapido con regolazione angolare permette un posizionamento individuale del portabevande.

PADDY

Art. 0404074N.C06

€ 37,50

100% Polyester

Comodo cuscino coprisedia imbottito. Adatto per sedie pieghevoli a schienale alto.

MESA

Art. 0404098N

€ 14,90

27 x 23 x H4 cm

400 g

Grande ripiano laterale per bevande e accessori in robusto materiale plastico.



C07



ARAVEL

GREY

Moderna sedia pieghevole a 4 gambe con schienale reclinabile a 7 posizioni.

CARATTERISTICHE:

- Struttura in profilo di alluminio ad alta portata
- Telo portante in tessuto 3D imbottito e traspirante
- Schienale ergonomico e reclinabile a 7 posizioni
- Schienale con poggiatesta imbottito integrato
- Braccioli in resistente materiale plastico
- Snodo centrale in acciaio
- Possibilità di collegare un poggiamambe
- Compatta e comoda da trasportare quando ripiegata



OPTIONAL

ARAVEL 3D M

Art. 0404065N.C07M

€ 129,90

47 x 44 x H48/121 cm

114 x 64,5 x 10 cm

5,3 kg

Eating Position

Lounger

7 Positions

Relax

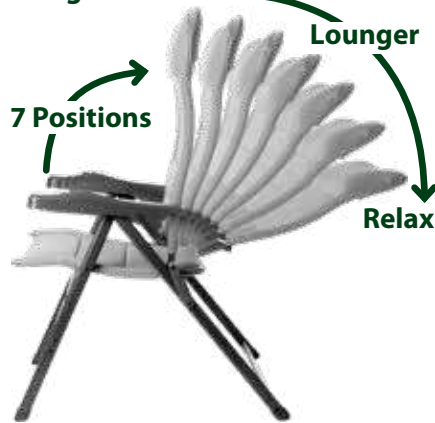

10 cm
Space Saver

ARAVEL 3D STANDALONE FOOTREST

Art. 0404073N.C07

€ 56,90

61 x 49 x H49 cm

67 x 60 x 8 cm

2,1 kg

Poggiatesta autoportante a 4 gambe con copertura FULL-3D traspirante con telaio in alluminio verniciato a polvere.

ARAVEL 3D FOOTREST

Art. 0404099N.C07

€ 59,90

51 x 71 x H48/43 cm

51 x 71 x 6 cm

1,35 kg

Poggiamambe pieghevole per sedia Aravel 3D M.

CARATTERISTICHE:

- Struttura in alluminio
- Telo portante in tessuto 3D imbottito e traspirante
- Compatto e comodo da trasportare quando ripiegato

ARAVEL 3D STOOL

Art. 0404084N.C07

€ 35,90

27 x 40 x H45 cm

42 x 60 x 4 cm

1,2 kg

Sgabello pieghevole Aravel 3D.

CARATTERISTICHE:

- Struttura in alluminio
- Telo portante in tessuto 3D imbottito e traspirante.
- Compatto e comodo da trasportare quando ripiegato



ARAVEL

DARK GREY & LIGHT GREY

Moderna sedia pieghevole a 4 gambe con schienale reclinabile a 7 posizioni.

CARATTERISTICHE:

- Struttura in profilo di alluminio ad alta portata
- Telo portante in Syntex Plus
- Schienale ergonomico e reclinabile a 7 posizioni
- Schienale con poggiatesta imbottito integrato
- Braccioli in resistente materiale plastico
- Snodo centrale in materiale plastico
- Possibilità di collegare un poggiamambe
- Compatta e comoda da trasportare quando ripiegata



C67

C53



OPTIONAL

ARAVEL SYNTEX

Art. 0404065N

€ 109,90

47 x 45 x H50/120 cm

112 x 65 x 9 cm

5 kg

ARAVEL FOOTREST

Art. 0404083N

€ 45,90

Poggiamambe pieghevole.

48 x 60/75 cm

48 x 75 x 6 cm

1 kg

CARATTERISTICHE:

- Struttura in alluminio
- Telo portante in Syntex Plus
- Compatto e comodo da trasportare quando ripiegato

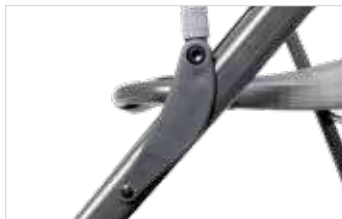

ARAVEL STOOL SYNTEX

Art. 0404084N

€ 32,90

Sgabello pieghevole Aravel.

27 x 40 x H45 cm

42 x 60 x 4 cm

1 kg

CARATTERISTICHE:

- Struttura in alluminio
- Telo portante in Syntex Plus
- Compatto e comodo da trasportare quando ripiegato

INFO



Le sedute in Syntex Plus si contraddistinguono per la loro popolarità ed il loro successo veramente duraturo. Si presentano con una elegante superficie strutturata (30% poliestere - 70% PVC) dal fascino visibile, ma discreto. L'alto livello di comfort ed una piacevole sensazione di freschezza sono solo due degli aspetti strettamente pratici che fanno della collezione nelle sue 2 varianti di colore una scelta perfetta per l'ambiente Outdoor.



OUTDOOR LIFESTYLE



INFO

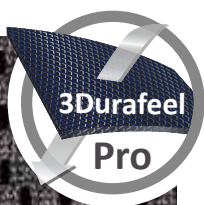
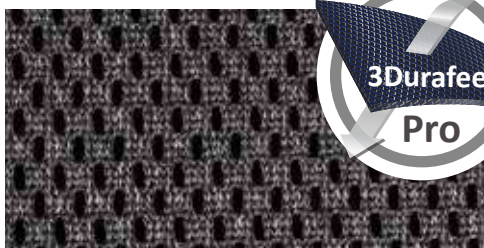

3DURAFEEL PRO REBEL / ARAVEL

Il tessuto di rivestimento 3Durafeel Pro è un tessuto molto speciale utilizzato nelle nostre collezioni di sedie Rebel e Aravel. Grazie alla sua permeabilità all'aria e alla delicatezza sulla pelle, trasforma il comfort in una meravigliosa esperienza di seduta per ore di relax all'aperto. 3Durafeel Pro si asciuga incredibilmente in fretta anche dopo una leggera pioggia e irradia una piacevole atmosfera di benessere sulla veranda, sulla terrazza o sul balcone. E questo in modo affidabile per molti anni. Infatti, 3Durafeel Pro è resistente allo strappo e all'abrasione, traspirante, resistente alla luce e repellente allo sporco. Costruzione monostrato (trama speciale).

REBEL

C69

C51



S M L



REBEL SMALL

Art. 0404002N

€ 149,90

46 x 44 x H46/117,5 cm

110 x 60 x 12 cm

5,5 kg



REBEL MEDIUM

Art. 0404002N

€ 149,90

48 x 46 x H48,5/123 cm

114 x 65 x 12 cm

6,1 kg



REBEL LARGE

Art. 0404002N

€ 159,90

54 x 45 x H51,5/125 cm

117 x 71 x 12 cm

6,5 kg



REBEL UNIVERSAL FOOTREST

Art. 0404003N

€ 64,90

95 x H43 cm

95 x H10 cm

1,80 kg



REBEL STANDALONE FOOTREST

Art. 0404004N

€ 62,90

61 x 49 x H49 cm

65 x 61 x 8 cm

2,1 kg



HOGGY REBEL STANDALONE

Art. 0404006N

€ 34,90

64 x 51 x H5,5 cm

1,7 kg

OPTIONAL

Poggiagambe universale per la collezione di sedie Rebel nelle 3 varianti di misura S-M-L. Attacco a clip sulla traversa rotonda.

Poggiapiedi autoportante a 4 gambe con copertura FULL-3D traspirante con telaio in alluminio verniciato a polvere.

Grande tavolo per sgabello con profilo perimetrale in alluminio, progettato appositamente per il poggia-gambe / sgabello indipendente Rebel.



C58



Licotex
73% PVC
27% PES

PHANTOM

BLACK



Schienale e seduta sono imbottiti per un elevato livello di comfort

**Extra
Comfort**



8 cm

Space Saver



originaldesign



Braccioli molto confortevoli



Struttura in profilato ovale di alluminio



Eating Position
 7 Positions
 Lounger
 Relax

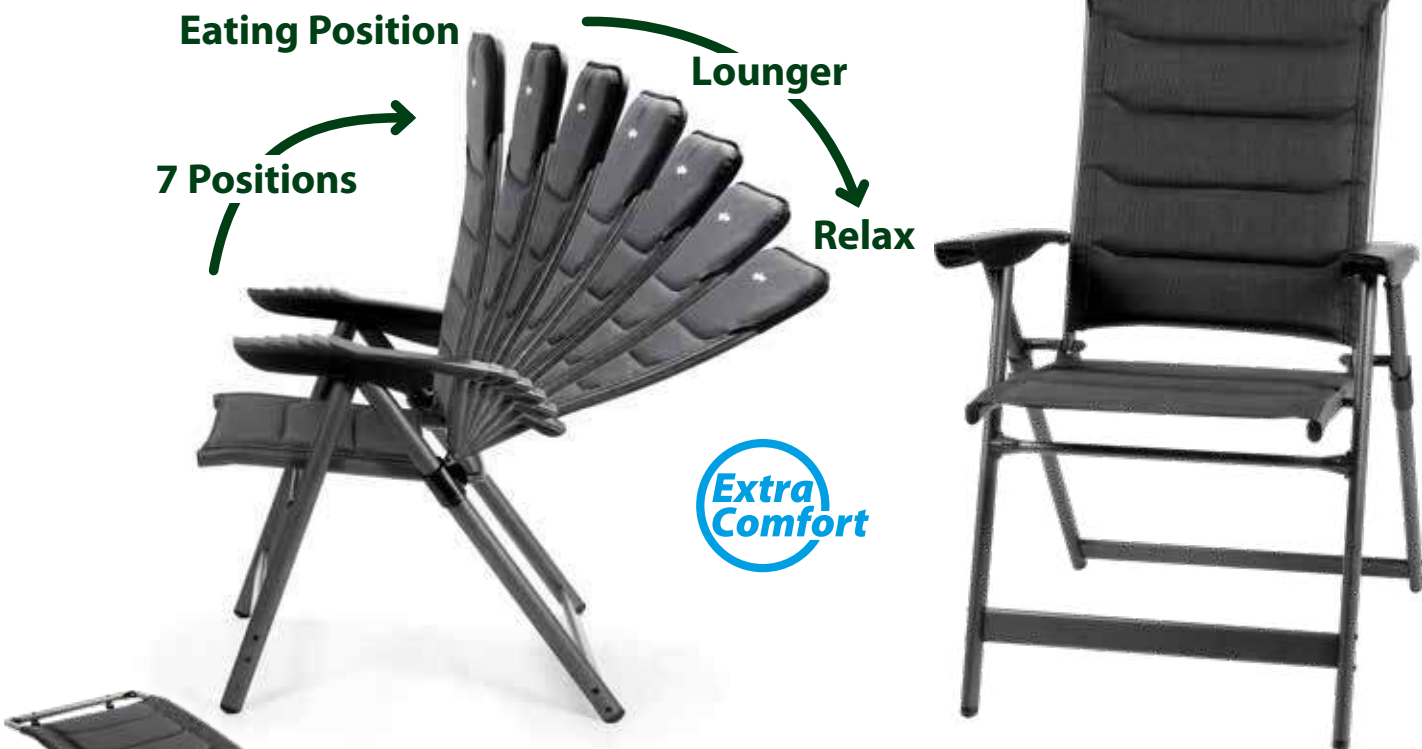

OPTIONAL

PHANTOM FOOTREST

Art. 0404059N.C58

€ 56,90

🔒 52 x 62,5 x H80,5 cm

🔒 47 x 69 x 6 cm

👤 1,2 kg

Poggiapiedi pieghevole per sedia Phantom.

PHANTOM STOOL

Art. 0404053N.C58

€ 29,90

🔒 27 x 40 x H45 cm

🔒 42 x 60 x 4 cm

👤 1,1 kg

Robusto sgabello pieghevole con seduta in tessuto Licotex resistente alle intemperie. Telaio salvaspazio in tubo tondo di alluminio.



PHANTOM

Art. 0404058N.C58

€ 134,90

🔒 48 x 38 x H48/121 cm

🔒 65,5 x 8 x H112 cm

👤 5,2 kg

Sedia pieghevole ultrapiatta con schienale reclinabile.

CARATTERISTICHE:

- Struttura in profilato ovale di alluminio
- Schienale reclinabile a 7 posizioni
- Ultrapiatta quando ripiegata
- Materiali di alta qualità
- Braccioli molto confortevoli
- Design moderno



ORBIT CHAIR L

Art. 0404010N.C20

€ 79,90

55 x 42 x H40/75 cm

45 x Ø 10 cm

1,2 kg



Sedia Outdoor con innovativa struttura pieghevole che permette di ottenere delle dimensioni molto compatte e perfette per il trasporto. La combinazione ideale di comfort, peso leggero e montaggio semplice. Un vero e proprio must-have per backpackers, bikers, campers e in generale per qualsiasi attività all'aria aperta. Completa di pratica sacca custodia.



DIR-ACTION DEMTEX

Art. 0404033N.C06

€ 49,90

54 x 44 x H44/82,5 cm

84 x Ø 15 cm

3,4 kg



Sedia regista Outdoor con telaio pieghevole. Braccioli imbottiti. Molto compatta quando ripiegata. Completa di sacca per il trasporto.



IKARO ULTRALIGHT



ultralight



IKARO ULTRALIGHT BEACH

IKARO ULTRALIGHT



IKARO ULTRALIGHT BEACH

Art. 0404120N

53 x 48 x H27/61 cm

56 x 52 x 9 cm

1,8 kg

€ 76,90

IKARO ULTRALIGHT

Art. 0404119N

54 x 65 x H42/89 cm

52 x 92 x 9 cm

2,18 kg

€ 88,50

Sedia pieghevole da esterno ultraleggera di dimensioni compatte quando ripiegata, peso ridotto ed eccellente trasportabilità. Con braccioli in legno elegantemente lavorati. Due tubi curvi sullo schienale e sul sedile possono essere utilizzati come maniglie per il trasporto.

DIRECTOR CHAIR

COLLECTION



BRAVURA

Art. 0404190N

€ 58,90

60 x 47 x H46/83 cm

11 x 49 x H83 cm

2,3 kg



Security System



Sedia regista con struttura pieghevole in alluminio. Schienale e seduta sono in poliestere antiscivolo. Seduta, schienale e braccioli sono imbottiti. Con meccanismo di chiusura di sicurezza.



CAPTAIN

Art. 0404184N

€ 59,90

48 x 46 x H45,5/81 cm

46 x 12 x H81 cm

2,8 kg

Security System



Sedia regista compatta con solida struttura in alluminio anodizzato.



BRAVURA COMFORT

Art. 0404192N.C06

€ 83,90

60 x 47 x H46/83 cm

11 x 49 x H83 cm

2,94 Kg



Sedia regista in alluminio altamente confortevole con struttura di sicurezza verniciata e pieghevole, braccioli imbottiti e due tipi di rivestimento:

- a) In tessuto Syntex resistente alle intemperie
- b) In poliestere sfoderabile ed imbottito



ONE SHOT

Art. 0404164N.C20

€ 49,90

56 x 45,5 x H46/81 cm

48 x 13,5 x H81 cm

2,15 kg



Sedia regista con struttura in alluminio.



DJANGO

Art. 0404198N

€ 39,90

49 x 45,5 x H42/81 cm

51 x 81 x H9 cm

3,2 kg



Security System



Sedia regista con telaio in acciaio verniciato a polvere e tela in poliestere. Sistema di chiusura di sicurezza.



EQUIFRAME

HIGH STABILITY



ACTION EQUIFRAME

Art. 0404035N

€ 32,90

50,5 x 57 x H46/77 cm

77 x 17 x H17 cm

2,75 kg

COLORS

Sedia pieghevole con speciale telaio brevettato che ne garantisce il non ribaltamento. Realizzata con telaio in acciaio verniciato e seduta in resistente tessuto di poliestere. Molto facile da aprire e chiudere. Completa di borsa per il trasporto.



ARMCHAIR EQUIFRAME

Art. 0404038N

€ 53,90

85 x 60 x H46/91 cm

94 x 18 x H18 cm

3,35 kg

COLORS

Sedia pieghevole con ampi braccioli realizzata con speciale telaio brevettato che grazie alla sua conformazione ne impedisce il ribaltamento. Realizzata con struttura in acciaio verniciato e seduta in resistente tessuto di poliestere. Semplicissima da aprire e richiudere. Completa di sacca per il trasporto. Disponibile in 3 colori.

INFO

Sedia pieghevole con speciale telaio brevettato che ne garantisce il non ribaltamento.





ACTION KIDS EQUIFRAME

Art. 0404193N

€ 39,90

 62,5 x 42 x H31/64,5 cm

 66 x 16 x H16 cm

 2,39 kg

COLORS 

ACTION BABY EQUIFRAME

Art. 0404191N.C73

€ 89,90

 49,5 x 67 x H58/94 cm

 94 x 20 x H20 cm

 4,7 kg



Sedia pieghevole per bambini con speciale telaio di sicurezza brevettato che grazie alla sua conformazione ne impedisce il ribaltamento. Realizzata con struttura autobloccante in acciaio verniciato e seduta in resistente tessuto di poliesteri. Semplicissima da aprire e richiudere. Completa di sacca per il trasporto. Disponibile in 3 colori vivaci ed attraenti.

Seggiolone salvaspazio da viaggio adatto per bambini dai 6 mesi fino a 4 anni (oppure 15 kg). Realizzato con speciale struttura di sicurezza in acciaio che grazie alla sua conformazione evita il ribaltamento del seggiolone stesso. La pratica seduta imbottita è facilmente lavabile e dispone di imbracatura regolabile con fissaggio a 3 punti. Completo di pratico vassoio.

CARATTERISTICHE:

- Braccioli imbottiti con bloccaggio di sicurezza
- Costruito e collaudato secondo la normativa EN16120
- Facile e veloce da ripiegare
- Telaio salvaspazio
- Imbracatura di sicurezza
- Con ampio vassoio per mangiare e bere
- Completo di sacca custodia





ACTION

OUTDOOR LIFESTYLE



ACTION SOFA

Art. 0404041N

€ 109,90

148 x 63 x H44/92 cm

23 x 18 x H106 cm

5,3 kg



Acciaio



COLORS

C03 C06

Divanetto con struttura pieghevole in metallo. Schienale in resistente tessuto imbottito.



ACTION SOFA 3D

Art. 0404041N.C09

€ 134,90

148 x 63 x H44/92 cm

23 x 18 x H106 cm

5,2 kg



Acciaio



Confortevole divano con struttura pieghevole in metallo.

CARATTERISTICHE:

- Tessuto poliestere 600D a doppio strato con inserti 3D
- Confortevoli braccioli con portabevande
- Design unico
- Con borsa di trasporto



ACTION SOFA RENDEZ-VOUS

Art. 0404047N.C03 € 149,90

- 147 x 65 x H44/99 cm
- 31 x 20 x H101 cm
- 8,3 kg



Divano per 2 persone di nuova concezione, molto confortevole, con struttura pieghevole leggermente angolata. Ideale per rilassarsi nella zona soggiorno di tende o verande. Con area organizer centrale dotata di due tasche in tessuto a zanzariera. Sedile e schienale comodamente imbottiti. Apertura e chiusura in pochi secondi senza necessità di montaggio speciale. La fornitura comprende una borsa per il trasporto e lo stoccaggio.



ACTION DELILAH NG

Art. 0404032N.C03 € 89,90

- 55 x 75 x H43/80 cm
- 89 x 46 x H12 cm
- 3,76 kg



Poltrona pieghevole con struttura tubolare in alluminio. Telo in robusto poliestere imbottito e trapuntato. Design moderno e confortevole. Perfetta in abbinamento con l'Action Sofa Rendez-Vous. Completa di sacca custodia.

CARATTERISTICHE:

- Schienale e seduta in tessuto imbottito e trapuntato
- Apertura e chiusura in pochi secondi
- Dimensioni compatte quando ripiegata
- Facile da trasportare

ACTION VIVAVITA LOUNGER

Art. 0404036N € 79,90

- 74 x 43 x H56/99 cm
- 118 x Ø 26 cm
- 4,05 kg



Il Vivavita Lounger è una sedia pieghevole elegante e super confortevole, perfetta per outdoor, campeggio e giardino. Grazie al suo design semplice ma funzionale, si apre e si chiude senza sforzo in pochi secondi, senza bisogno di montaggio. Il telaio verniciato a polvere è dotato di una copertura in poliestere riccamente imbottita. Una borsa per il trasporto è inclusa nella fornitura.



ACTION VIVAVITA RELAXER

Art. 0404030N € 127,90

- 75 x 44 x H43/95 cm
- 119 x 15 x H10 cm
- 5,0 kg



La Action Vivavita Relaxer dispone di una struttura in alluminio verniciato a polvere, particolarmente leggera. Seduta molto morbida in poliestere. Facile da trasportare.

CARATTERISTICHE:

- Design moderno ed elegante
- Elevato comfort di seduta
- Completa di sacca per il trasporto





RAPTOR

FOLDING CHAIR COLLECTION



INFO

- Telaio in robusto acciaio verniciato
- Tessuto poliestere resistente alle intemperie
- Pieghevole e compatta
- Con porta bibite integrato (XL/Enduro/Compact)
- Con sacca custodia

RAPTOR CLASSIC

Art. 0404040N

€ 63,90

 51 x 44 x H48/90 cm

 94 x Ø 16cm

 4,6 kg



COLORS    

Confortevole sedia pieghevole con sostegno laterale della seduta.



RAPTOR HIGHBACK

Art. 0404016N

€ 79,90

51 x 44 x H48/110 cm

114 x ø 16 cm

6 kg



COLORS

Per offrire un comfort ancora maggiore pur mantenendo dimensioni di ingombro molto compatte, la Raptor, la nostra preferita di sempre tra le sedie pieghevoli, è stata dotata di uno schienale rialzato di circa 20 cm. L'uso di comodi braccioli in plastica robusta dà inoltre la sensazione di essere seduti su una classica sedia a 4 gambe. Tutte le altre caratteristiche di questa gamma di sedie sono state mantenute.

RAPTOR COMPACK

Art. 0404055N

€ 65,90



61,5 x 60 x H46/90 cm

27 x 21 x H92 cm

4,8 kg



COLORS

La nuova sedia Raptor Compact si caratterizza per la sua nuova struttura pieghevole che ne garantisce il minimo ingombro una volta chiusa e riposta, senza che ciò precluda l'abituale livello di confort delle sedie della collezione Raptor. Realizzata con telaio in acciaio verniciato a polvere e telo portante in robusto tessuto di poliestere spalmato. Completa di sacca per il trasporto.

RAPTOR DEMTEX

Art. 0404054N

€ 73,90



51 x 44 x H48/90 cm

94 x ø 16cm

4,6 kg



COLORS

L'apprezzata sedia pieghevole Raptor realizzata in due colori di tendenza con l'innovativo tessuto Demtex, abbinato alla collaudata struttura in acciaio verniciato.

CRUISER

Art. 0404039N

€ 53,90



51 x 44 x H48/90 cm

94 x ø 16cm

4,6 kg



COLORS



Confortevole sedia pieghevole con sostegno laterale della seduta. Grande stabilità grazie alla struttura in tubo ovale verniciata a polvere ed alle larghe basi regolabili dei piedi. Telo in robusto tessuto poliestere.



RAPTOR

FOLDING CHAIR COLLECTION



RAPTOR NG 2.0

Art. 0404014N.C03

€ 69,90

51 x 44 x H48/90 cm

94 x Ø 16 cm

4,8 kg



Sedia pieghevole molto confortevole con imbottitura 3D. Costruzione salvaspazio. Borsa da trasporto inclusa.

Sono stati apportati i seguenti miglioramenti alla versione aggiornata 2.0:

- Braccioli di nuova concezione con elegante e confortevole terminale in plastica
- Le aree laterali del rivestimento dello schienale sono completamente imbottite con tessuto 3D



RAPTOR 3D

Art. 0404034N.C03

€ 69,90

51 x 44 x H48/90 cm

94 x Ø 16 cm

4,6 kg



Comoda e moderna: questa versione della sedia Raptor è dotata di un tessuto traspirante e ad asciugatura rapida. Mediante l'utilizzo della collaudata struttura Raptor rimane invariata l'eccellente stabilità di questo modello di sedia pieghevole.



RAPTOR RECLINER

Art. 0404050N.C20

€ 107,90

51 x 45 x H45/102 cm

96 x Ø 25 cm

6,34 kg



Sedia pieghevole con schienale reclinabile a 3 posizioni. Con piedini antiprofondamento. Molto confortevole.

RAPTOR FOOTREST 3D

Art. 0404018N.C03 € 49,90

48 x 65 x H37 cm

65 x 18 x H11 cm

2,9 kg



Poggiagambe indipendente e autoportante con rivestimento in tessuto 3D. Ingombro ridotto grazie al pratico telaio pieghevole. Si adatta a tutte le sedie e poltroncine pieghevoli con rivestimento in tessuto 3D. Con sacca custodia.

BUTTERFLY NG

Art. 0406048N.C20

€ 29,90

50 x 50 x H45 cm

63,5 x Ø 17 cm

1,4 kg



Tavolo pieghevole Outdoor con speciale meccanismo di tensionamento per il ripiano del tavolo in tessuto. Con comoda sacca per il trasporto.





RAPTOR ENDURO

Art. 0404025N.C20 € 71,90

56 x 42 x H44/95 cm

110 x Ø 21 cm

5,25 kg



Sedia pieghevole realizzata con una struttura particolarmente robusta e stabile. Le dimensioni maggiorate garantiscono una seduta confortevole anche a persona di statura superiore alla media. Completa di pratica sacca per la custodia.



RAPTOR XL

Art. 0404015N.C03 € 92,50

65 x 63 x H110 cm

114 x Ø 22 cm

6 kg



La nuovissima sedia pieghevole Raptor XL è il plus ultra per persone di statura superiore alla media. Naturalmente possiede tutti i vantaggi ed i miglioramenti dell'apprezzata serie di sedie pieghevoli Raptor.



RAPTOR SUSPENSION

Art. 0404024N.C20 € 57,90

51 x 40 x H47/94 cm

110 x Ø 20 cm

4,95 kg



Comoda sedia pieghevole con schiena a sospensione elastica. Con borsa per il trasporto.



Lumbar support



KADRE

Art. 0406041N

€ 31,90

40 x 35 x H29 cm

45 x 12 x H12 cm

1,20 kg



Tavolino di appoggio molto compatto con piano arrotolabile in alluminio verniciato. Telaio in acciaio pieghevole. Molteplici usi. Con borsa per il trasporto.



SEDESI SEMPRE ED OVUNQUE



OUTDOOR COT

Art. 0410032N.C30 € 117,50

 190 x 64/72 x H43 cm

 95 x 21 x H14 cm

 4,8 kg



Letto da campo con struttura pieghevole e smontabile in alluminio.

NEW
2023



OUTDOOR COT XL2

Art. 0410045N € 139,90

 210 x 80 x H50 cm

 103 x 20 x 12 cm

 6,5 kg



Letto da campo di ampie dimensioni. Telaio in alluminio anodizzato.



OUTDOOR COT AUTOMATIC

Art. 0410044N € 114,50

 191 x 66 x H44 cm

 105 x 15 x H15 cm

 8,9 kg



Letto da campo robusto con struttura pieghevole appositamente progettata per essere aperta e ripiegata in un istante. Comoda tela in resistente tessuto di poliestere con poggiatesta integrato e imbottito. Di dimensioni compatte quando ripiegato. Con pratica borsa per il trasporto.



NIRO

Art. 0404107N.C03

€ 17,90

32 x 32 x H40 cm

58 x Ø 9 cm

450 g



Sgabello treppiede compatto. Borsa da trasporto inclusa.



TRIOL

Art. 0404089N

€ 17,90

31 x 34 x H42 cm

60 x Ø 9 cm

1,2 kg



Sgabello treppiede con struttura in tubo di acciaio verniciato.



FJORD

Art. 0404051N

€ 23,90

35 x 35 x H45 cm

61 x Ø 9 cm

500 g



Sgabello treppiede pieghevole con struttura in alluminio anodizzato Ø 19 mm.



BIG FJORD

Art. 0404103N

€ 24,90

35 x 35 x H65 cm

76 x Ø 10 cm

800 g



Sgabello treppiede pieghevole con struttura in alluminio anodizzato Ø 19 mm.



ROTO

Art. 0404046N

€ 24,90

32 x 32 x H43 cm

60 x Ø 17,5 cm

1,4 kg



Sgabello treppiede con comoda seduta rotante a 360°.



JOLLY

Art. 0404105N

€ 19,90

38 x 20,5 x H34 cm

23,5 x 28 x 2 cm

950 g



Sgabello pieghevole con solido telaio in filo di acciaio verniciato Ø 6 mm.



TWISTY SQUARE

Art. 0404116N

€ 49,90

32 x 24 x H40 cm

32 x 45 x 5 cm

1,32 kg



Sgabello pieghevole di alta qualità con struttura in alluminio ed elegante seduta in bambù. Design robusto, affidabile ed elegante. Pronto all'uso in pochi secondi e molto comodo da trasportare quando non in uso a causa delle piccole dimensioni quando ripiegato. Utilizzo molto versatile. Con borsa custodia.



TWISTY OVAL

Art. 0404117N

€ 49,90

36 x 30 x H40 cm

36 x 45 x 5 cm

1,32 kg





BEACH BED

COLLECTION



BAHIA

Art. 0410013N

€ 99,90

192 x 61,5 x H31,5 cm

66 x 62 x H12,5 cm

4,9 kg



COLORS

C00 C08

Letto da sole con tela in Syntex resistente alle intemperie e resistenti snodi metallici.

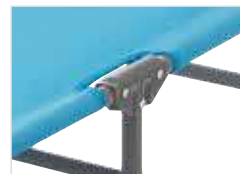

**BEST
SELLER**



MALIBU'

Art. 0410011N

€ 109,90

189 x 61 x H26 cm

79 x 61 x 16,5 cm

5,2 kg



COLORS

C06 C30

Letto da sole a tre gambe con pratico tettuccio parasole.



DUNA GRAND SLIMVISION

Art. 0410060N.C54

€ 149,90

200 x 65 x H40 cm

85 x 65 x H21 cm

5,7 kg



Brandina da spiaggia a 3 gambe di grandi dimensioni.





MARBELLA

Art. 0410012N

€ 134,90

192 x 67 x H30 cm

77 x 19 x H64,5 cm

6,4 kg



COLORS



Letto da sole di alta qualità con struttura quadrangolare, a tre piedi ripiegabili in alluminio anodizzato. Tettuccio parasole regolabile.



MARBELLA HIGH

Art. 0410022N

€ 169,90

198 x 64 x H48 cm

84 x 24 x H72 cm

7,50 kg



COLORS



Letto da sole molto confortevole con struttura stabile e pieghevole a tre gambe in alluminio anodizzato, seduta molto alta (H=48 cm) realizzata in tessuto Syntex Plus resistente agli agenti atmosferici e schienale regolabile. La fornitura comprende un pratico tettuccio parasole.

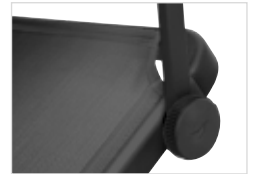

BETA

Art. 0406013N

€ 19,90

30 x 30 x H55/76 cm

880 g

Praticissimo tavolino da spiaggia con piede regolabile e telescopico in acciaio verniciato.





BULA

BEACH CHAIRS

Accomodarsi e rilassarsi - grazie alla sua speciale costruzione la spiaggia Bula XL raggiunge livelli altissimi in termini di comodità e relax.

CARATTERISTICHE:

- Seduta rialzata
- Alzarsi è più facile
- Seduta più larga
- Braccioli imbottiti
- Telaio pieghevole verniciato a polvere
- Piedini antiprofondamento
- Tessuto in resistente poliestere
- Con borsa per il trasporto



BULA

Art. 0404148N

€ 53,90

Spiaggina pieghevole e compatta. Borsa da trasporto inclusa.

57 x 50 x H73,5 cm

68 x Ø 18 cm

3,1 kg



COLORS



BULA XL

Art. 0404149N

€ 78,90

61 x 74 x H87/31 cm

98 x Ø 18 cm

4,7 kg



COLORS



CUBA

BEACH CHAIRS



CUBA

Art. 0404147N

€ 46,90

Spiaggina pieghevole dal design moderno e funzionale.

- 57 x 43 x H64 cm
- 78 x Ø 14 cm
- 3,1 kg



CUBA AIRBACK

Art. 0404135N.C57

€ 46,90

Spiaggina pieghevole con caratteristiche identiche al collaudato modello Cuba, ma con schienale realizzato in rete traspirante e idrorepellente.

- 57 x 43 x H64 cm
- 78 x Ø 14 cm
- 3,1 kg



SIREN

Art. 0404152N

€ 69,90

Sedia da spiaggia in alluminio con schienale reclinabile a 4 posizioni e cuscino per un maggior comfort. Leggera e facile da trasportare. Perfetta per rilassarsi e godersi il sole in piscina o in spiaggia.

- 64 x 63 x H28/82 cm
- 74 x 66 x H12 cm
- 3,6 kg

CARATTERISTICHE:

- Schienale reclinabile in posizione completamente orizzontale
- Con gamba di supporto schienale pieghevole
- Confortevoli braccioli





CARGO

Art. 0814003N

€ 199,90

111 x 55 x H65 cm

36 x 21 x H84 cm

12,9 kg



Carretto pieghevole con struttura in robusto acciaio verniciato a polvere.

<M>
mountless
the smart
folding system



CARGO CROSS

Art. 0814014N

€ 216,50



102 x 58 x H65 cm

40 x 25 x H84 cm

12,5 kg



Carretto fuoristrada con telaio in acciaio pieghevole e ruote XXL. Costruzione robusta. Non è necessario alcun montaggio.

CARGO





CARGO COMPACT

Art. 0814013N € 129,90



- 101 x 50 x H55 cm
- 33 x 20 x H73 cm
- 9 kg



Esecuzione come il modello Cargo, ma di dimensioni più compatte.



<M>
mountless
 the smart
 folding system





NEW
2023

CARGO TRUCK

Art. 0814016N

€ 209,90

138 x 55 x 92 cm

31 x 19 x 74 cm

11,8 kg

XXL



steel
Acciaio

100% Polyester

100kg

Il nuovo Cargo Truck è un carretto multifunzionale realizzato in robusto acciaio verniciato a polvere, telaio pieghevole salvaspazio e ruote XXL adatte anche per terreni sterrati e/o sabbiosi. La speciale costruzione dotata di involucro in resistente poliestere spalmato prevede anche la possibilità di aprire la parete posteriore per facilitare le operazioni di carico e scarico oppure per trasportare oggetti fuori misura. Utilizzo semplice e veloce che non necessita di montaggio. Completo di sacca per il trasporto.

IMPROVED



BEACH CART NG

Art. 0814001N.C57

€ 54,90

101 x 50 x H36 cm

101 x 36 x H6 cm

3,5 kg

steel
Acciaio

100% Polyester

100kg

Carrello multi-funzione pieghevole realizzato in acciaio verniciato a polveri. Ruote extra-larghe ed estraibili.







MINI ROLLY

Art. 0814007N

€ 29,90

 93,4 x 24,5 x 35 cm

 43 x 24,5 x 12,5 cm

 950 g

 35 kg

Carrello da trasporto con struttura telescopica in acciaio pieghevole e raccordi in resistente materiale plastico. Ruote larghe.

**BEST
SELLER**



PICK UP

Art. 0814009N

€ 23,90

 32 x 28 x 87 cm

 32 x 10 x 48,5 cm

 1,9 kg

 30 kg

Pratico trolley pieghevole con grandi ruote che rendono possibile l'utilizzo anche su terreni sterrati. Esecuzione leggera e stabile con profilo in acciaio verniciato a polvere. Cinghie di fissaggio incluse.



EASY

Art. 0814005N

€ 49,90

 46 x 35 x 99 cm

 16 x 35 x 56 cm

 3,3 kg

 90 kg

Carrello pieghevole con robusta struttura in acciaio.



AXA

Art. 0814004N

€ 79,90

 50 x 45 x 98 cm

 50 x 72 x 6 cm

 4,4 kg

 90 kg

Carrello pieghevole in alluminio con apertura automatica del piano di appoggio. Elastici ferma carichi sono inclusi nella fornitura.



TABLE COLLECTION

SCEGLIAMO IL TAVOLO GIUSTO!

Un tavolo è in realtà non altro che un ripiano con quattro gambe: questo è il primo pensiero che viene in mente alla maggior parte delle persone prima di aver considerato seriamente l'acquisto di un tavolo outdoor.

Ma soprattutto, quando si parla di tavoli outdoor, un tavolo non è affatto un semplice tavolo. Numerose differenze sono da considerare: la funzione, il luogo di utilizzo, il sistema di montaggio e le dimensioni di trasporto.

Questo solleva automaticamente la domanda: quali tavoli Outdoor e Camping sono effettivamente disponibili sul mercato?

Tavoli da campeggio e da esterno classici con piano fisso o pieghevole

Tavoli da campeggio e da esterno ultraleggeri con piano fisso o pieghevole

Tavoli da campeggio e da esterno pieghevoli con vassoio arrotolabile

Trovate ora il tavolo più adatto alle vostre necessità consultando la nostra vasta gamma di modelli con diverse funzioni, sistemi di montaggio, dimensioni di trasporto, colori e forme. Considerate le regole di base spiegate qui sopra, le proprie esigenze speciali ed il proprio stile preferito, vi rimane soltanto di tenere conto dell'ambiente circostante e delle condizioni di spazio preesistenti.

DINEMIC

ALUMINIUM TABLE TOP



<M>
mountless
 the smart
 folding system



DINEMIC 4

Art. 0406053N

€ 239,90

126 x 70 x H56/85 cm

68 x 64 x 11 cm

8,2 kg

Il Dinemic 4 è un tavolo per Outdoor e Camping di alta qualità con speciale piano pieghevole realizzato mediante l'utilizzo di listelli in alluminio molto resistenti alle intemperie ed all'usura. La struttura in metallo verniciato a polvere è munita di gambe regolabili in altezza. Può essere riposto in modo molto compatto quando ripiegato ed è quindi ideale per minibus, furgoni e camper.

CARATTERISTICHE:

- Piano del tavolo resistente alle intemperie, adatto per uso esterno
- Costruzione robusta in metallo
- Regolazione senza scatti delle gambe del tavolo
- Pieghevole centralmente
- Leggero e facile da trasportare e riporre
- Completo di telo di protezione



ACCELERATE CLASSIC

ROLLABLE TABLE TOP



PATENTED

ACCELERATE 4

Art. 0406091N

€ 179,90

120 x 80 x H71 cm

124 x 18 x 18 cm

7,3 kg

ACCELERATE 6

Art. 0406092N

€ 199,90

146,5 x 80 x H71 cm

151 x 20,5 x 19 cm

8,5 kg

LOCKING SYSTEM



LEVEL SYSTEM

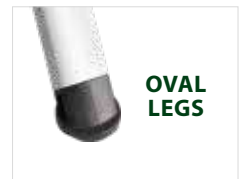

**MAX
2 cm**

**OVAL
LEGS**



La crescente popolarità del campeggio e del caravaning porta le comodità di tutti i giorni ad un livello completamente nuovo. Il tavolo Accelerate con ripiano arrotolabile è diventato uno dei tavoli da campeggio più leggeri, versatili e portatili sul mercato.

CARATTERISTICHE:

- Telaio in alluminio con tubo semiovale
- Ripiano arrotolabile con sistema Gapless
- Gambe pieghevoli
- Piedino regolabile
- Nuovo sistema di fissaggio del ripiano del tavolo
- Pratico ripiano in rete
- Borsa da trasporto inclusa

ACCELERATE COMPACT 4

ROLLABLE TABLE TOP



LOCKING SYSTEM



LEVEL SYSTEM

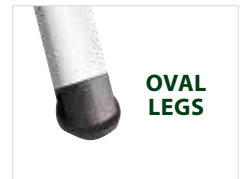

ACCELERATE COMPACT 4

Art. 0406093N

€ 187,90

120 x 80 x H71 cm

80 x 21 x 23,5 cm

7,3 kg

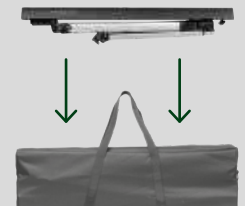
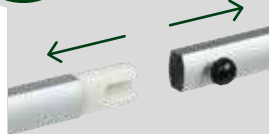

L'Accelerate Compact 4 è l'ulteriore sviluppo del tavolo arrotolabile di successo Accelerate 4. Il design del telaio di nuova concezione consente di ridurre notevolmente le dimensioni del pacco, soddisfacendo così i requisiti di ingombro di minibus, van e camper furgonati.

CARATTERISTICHE:

- Adatto per max. 4 persone
- Telaio in alluminio con sistema a innesto
- Regolazione livello
- Piano d'appoggio in alluminio senza interruzioni
- Confezione molto compatta
- Con pratico ripiano in rete
- Con borsa di trasporto

originaldesign



TITANIUM AXIA



ROLLABLE TABLE TOP



TITANIUM AXIA 2

Art. 0406097N

€ 139,90

104 x 62 x 72 cm

105 x 19 x 18 cm

5,5 kg

TITANIUM AXIA 4

Art. 0406098N

€ 164,90

122 x 76 x H72 cm

122 x 18 x 17 cm

7,1 kg

TITANIUM AXIA 6

Art. 0406099N

€ 189,90

147 x 76 x H72 cm

147 x 18 x 20 cm

8,2 kg

LOCKING SYSTEM



LEVEL SYSTEM



MAX
2 cm

SQUARE
LEGS



Tavolo in alluminio brevettato con ripiano arrotolabile e speciale telaio pieghevole di facile montaggio.

CARATTERISTICHE:

- Piano arrotolabile con listelli anodizzati color argento (sistema Gapless)
- Con livella a bolla integrata
- Telaio molto stabile realizzato con tubi quadrati in alluminio e barra stabilizzatrice centrale
- Piedino regolabile
- Con comoda rete e borsa da trasporto con due scomparti separati

TITANIUM QUADRA TROPIC

ROLLABLE TABLE TOP



QUADRA TROPIC 4

Art. 0406095N

€ 239,90

120,5 x 70 x H72 cm

122 x 17,5 x 24,5 cm

7 kg

QUADRA TROPIC 6

Art. 0406096N

€ 264,90

146 x 70 x H72,5 cm

149 x 32 x 14,5 cm

8,3 kg



PATENTED

La versione elegante del Titanium Quadra NG. Ripiano in alluminio con listelli terminali in vero legno di bambù e livella a bolla d'aria integrata per il perfetto funzionamento del nuovo sistema di livellamento 90° Adjustar. Con borsa da trasporto.



INFO



ADJUSTAR LEVELLING SYSTEM

Adjustar è un sistema di livellamento brevettato che permette una regolazione molto semplice dell'altezza delle gambe di appoggio mediante un nuovo metodo meccanico di trasmissione della spinta.

Grazie a questo meccanismo è possibile evitare che i mobili pendano in una direzione. Ogni camperista conosce questo problema e quanto sia laborioso e noioso regolare le gambe dei tavoli che devono essere spostati in alto, in basso e lateralmente, soprattutto quando ci si trova su terreni irregolari.

Ma Adjustar può essere utilizzato anche su terreni pianeggianti. Soprattutto se utilizzati negli spazi esterni, sui piani dei tavoli si formano piccole pozzanghere, che in combinazione con impurità come il polline, per fare un esempio, danno luogo a sgradevoli sbavature. Grazie al sistema Adjustar è possibile inclinare i tavoli per far defluire l'acqua.

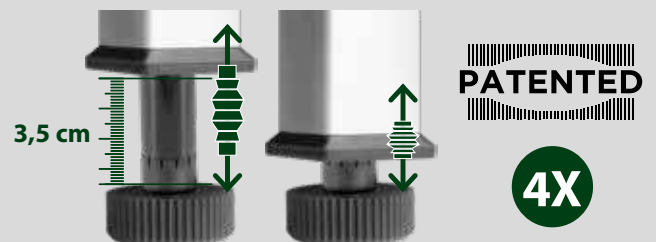



TITANIUM QUADRA NG

ROLLABLE TABLE TOP



TITANIUM QUADRA 4 NG

Art. 0406054N

€ 199,90

TITANIUM QUADRA 6 NG

Art. 0406065N

€ 229,90

120,5 x 70 x H72 cm

122 x 17,5 x 24,5 cm

6,3 kg

146 x 70 x H72,5 cm

149 x 32 x 14,5 cm

7,5 kg

LEVEL SYSTEM
PATENT PENDING

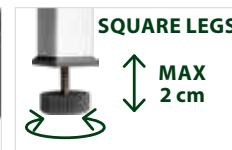
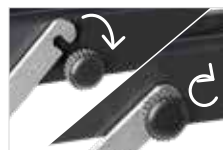

La nuova gamma di tavoli Quadra in alluminio con piano arrotolabile è caratterizzata da un nuovissimo telaio pieghevole, basato sulla classica costruzione del tavolo a 4 gambe verticali. Il piano del tavolo cosiddetto Gapless poiché senza intercapedini, è collegato al telaio del tavolo con uno speciale meccanismo di bloccaggio rapido. A differenza dei classici tavoli pieghevoli con telaio a X, il Quadra offre spazio sufficiente per le gambe su tutti e 4 i lati. Installazione facile e veloce. Design moderno combinato con una funzionalità migliorata. Una borsa custodia per il trasporto.

TITANIUM QUADRA 4 COMPACT

ROLLABLE TABLE TOP



LOCKING SYSTEM



LEVEL SYSTEM



SQUARE LEGS

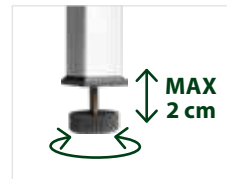

SMARTLOCK



TITANIUM QUADRA COMPACT 4

Art. 0406056N

€ 199,90

120,5 x 70 x H72 cm

85 x 22 x 23,5 cm

6,3 kg

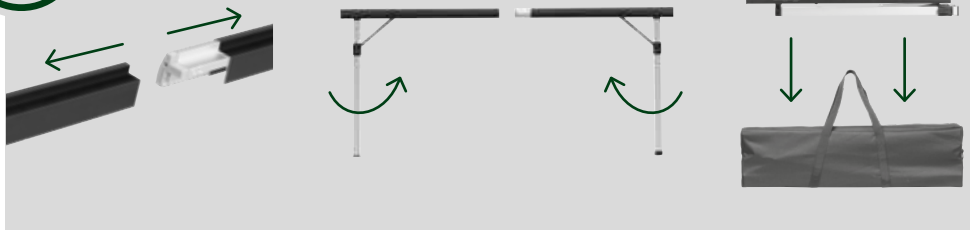

Il tavolo rotabile Quadra Compact 4 si distingue per la struttura del telaio divisibile di nuova concezione, che consente di ridurre notevolmente le dimensioni dell'imballaggio e si adatta quindi alle particolari esigenze di spazio di minibus, van e camper furgonati. Rispetto al Quadra Classic, la stabilità, la funzionalità e l'aspetto rimangono invariati.

CARATTERISTICHE:

- Adatto per un massimo di 4 persone
- Telaio in alluminio con sistema a innesto
- Regolazione livello
- Piano del tavolo in alluminio senza fessure (Gapless)
- Confezione molto compatta
- Con sacchetto di imballaggio

originaldesign



SILVER GAPLESS

ROLLABLE TABLE TOP



SILVER GAPLESS LEVEL 4

Art. 0406076N

€ 109,90

- 110 x 71 x H70 cm
- 107 x 18 x H20 cm
- 7,1 kg



SILVER GAPLESS LEVEL 6

Art. 0406077N

€ 129,90

- 140 x 81 x H70 cm
- 124 x 22 x H22 cm
- 9 kg



LEVEL SYSTEM

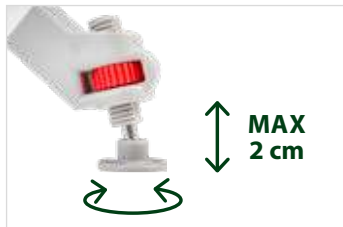

Tavolo pieghevole in alluminio con ripiano arrotolabile. Grazie alla speciale livella a bolla integrata, è possibile ottenere un posizionamento assolutamente orizzontale del ripiano su terreni irregolari (Level System). Struttura stabile con una gamba regolabile in altezza. È inclusa una borsa per il trasporto.



HOGGY FIX

Art. 0406052N

€ 19,90

- 40 x 40 cm
- 1,1 kg



TOP FOR STOOL STOOL NOT INCLUDED



Piano per sgabelli con superficie laminata resistente ai graffi.

LEVIN ULTRALIGHT

ROLLABLE TABLE TOP



ultralight



LEVIN 2

Art. 0406085N

€ 139,90

80 x 60 x H70 cm

80 x 18 x 11 cm

3,2 kg

LEVIN 4

Art. 0406086N

€ 164,90

110 x 67 x H70 cm

110 x 20 x 15 cm

4 kg

LEVEL SYSTEM



Tavolo da esterno pieghevole con struttura in alluminio ultraleggero e ripiano arrotolabile. Costruzione completamente priva di materiali sintetici, senza snodi o connettori in plastica. Tutti i tubi che compongono il telaio sono dotati di elastici di solidarizzazione per evitare la perdita di singole parti. Il montaggio è rapido, molto semplice e non sono necessari attrezzi. Ottime dimensioni di imballaggio per un facile stoccaggio. Viene fornito con una pratica borsa per il trasporto.



HOGGY SET

Art. 0406051N.C03

€ 44,90



40 x 40 x H43 cm

55 x 40 x 7,4 cm

1,6 kg



Pratico set composto da un leggero sgabello pieghevole in alluminio con seduta in poliestere e robusto piano del tavolo. Viene fornito con borsa di trasporto.



TORUN



Nuova serie di tavoli con ripiano in alluminio e gambe pieghevoli in acciaio verniciato. Compatti e facili da trasportare. L'impiego di materiali di alta qualità garantisce un utilizzo duraturo nel tempo.

SPACE SAVER 5 cm



TORUN 2

Art. 0406101N

€ 63,90

80 x 60 x H71 cm

80 x 60 x 5 cm

4,2 kg

TORUN 4

Art. 0406102N

€ 74,90

110 x 61,5 x H71 cm

110 x 61,5 x 5 cm

5,1 kg

<M>
mountless
the smart
folding system



FLATPACK 4

Art. 0406105N

€ 94,90

120 x 60 x H70 cm

60 x 60 x 8 cm

6,5 kg

Tavolo Outdoor di ottima qualità con ripiano pieghevole resistente alle intemperie e struttura leggera in alluminio anodizzato regolabile in altezza. Molto compatto quando ripiegato e quindi indicatissimo per minibus, van e camper furgonati.

CARATTERISTICHE:

- Ripiano resistente alle intemperie, adatto per l'uso esterno
- Stabile struttura in profilo rettangolare di alluminio
- Regolabile in altezza senza scatti
- Ripiano pieghevole a metà
- Leggero e facile da trasportare quando ripiegato

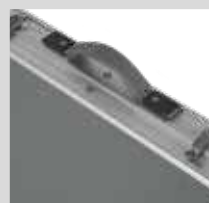

<M>
mountless
 the smart
 folding system

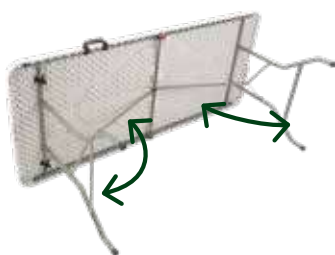

CLUB

BLOW-MOLDED TABLE TOP

Tavolo pieghevole Club

CARATTERISTICHE:

- Sistema bloccagambe di sicurezza
- Gambe regolabili in altezza
- Molto piatti quando ripiegati - facile da riporre
- Ripiano in plastica PE soffiato
- Gambe tavolo in acciaio verniciato a polvere, effetto martellato
- Lunga durata



weatherproof



Acciaio

CLUB 120

Art. 0406018N

€ 84,90

120 x 59 x H74 cm

60 x 59 x H9 cm

10 kg



CLUB 150

Art. 0406010N

€ 94,90

152 x 71 x H74 cm

76 x 71 x H9 cm

12 kg





CAMPERKING

BAMBOO



CAMPERKING S

Art. 0406089N

€ 129,90

80 x 60 x H49/58/70 cm

82,5 x 63 x 7 cm

7 kg

CAMPERKING M

Art. 0406090N

€ 169,90

100 x 72 x H49/58/70 cm

102 x 39 x 10 cm

8,6 kg

Tavolo Outdoor con struttura in metallo e ripiano in bambú.

CARATTERISTICHE:

- Struttura pieghevole (sistema Mountless) in profilato di alluminio
- Ripiano in resistente bambú per esterni
- Piedino regolabile di livellamento
- Molto compatto e facile da riporre quando ripiegato
- Ottima stabilità
- Con pratica maniglia per il trasporto

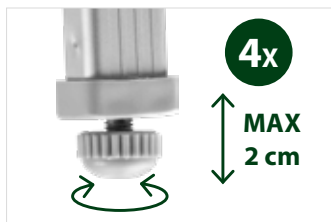

CAMPERKING R

BAMBOO



Tavolo rotondo per camping e outdoor con piano pieghevole a 4 elementi realizzato in elegante legno di bambù e struttura in alluminio regolabile in altezza. Dimensioni di ingombro molto compatte.

CAMPERKING R

Art. 0406084N

€ 219,90



🔒 Ø 90 x H49/58/70 cm

🔒 90 x 10 x H25 cm

🔒 7,9 kg

4-fold table top

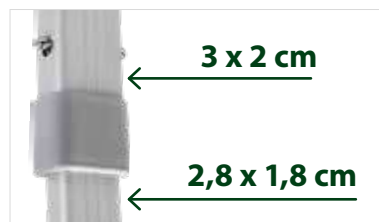
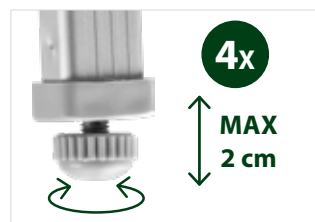
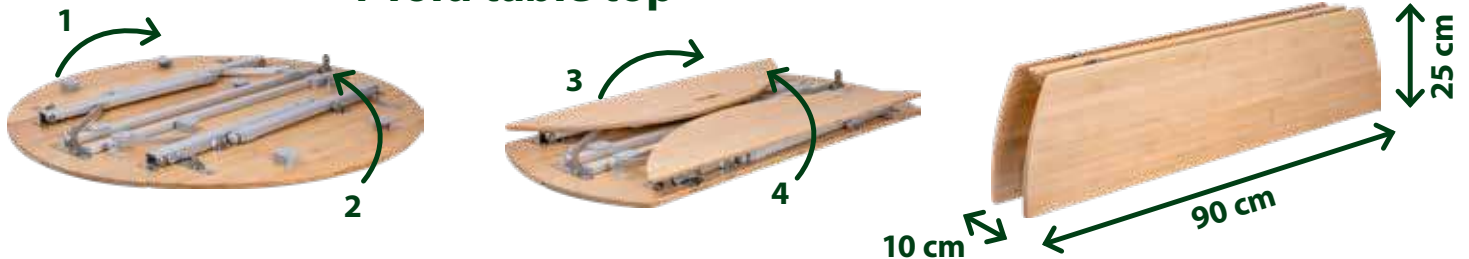



LINEAR

BLACK



<M>
mountless
the smart
folding system



I modelli di tavolo della serie Linear sono dotati di ripiani di alta qualità resistenti alle intemperie ed al calore.

CARATTERISTICHE:

- Altezza regolabile senza scatti
- Gambe tavolo telescopiche verniciate a polvere
- Ripiano di qualità resistente alle intemperie ed al calore (180°C)
- Facile da pulire



LINEAR 80

Art. 0406037N.C69

€ 79,90

80 x 60 x H63/83 cm

80 x 60 x 7 cm

6,8 kg

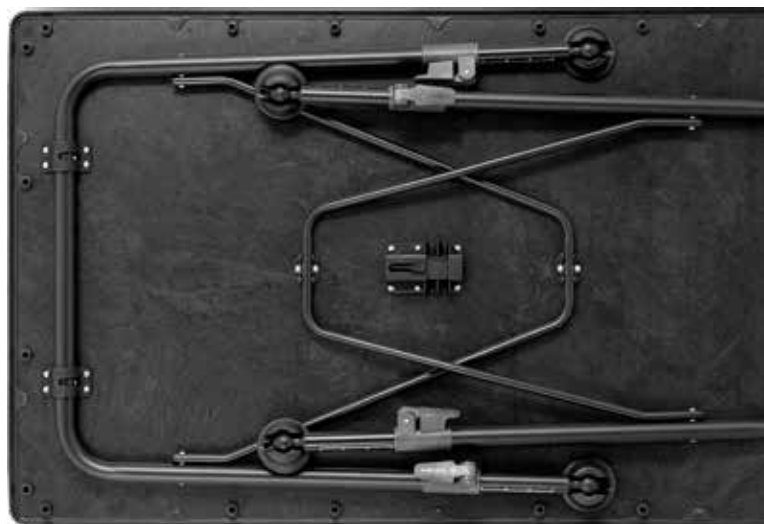

originaldesign ➤



Bordo del tavolo in materiale plastico
Ripiano resistente alle intemperie

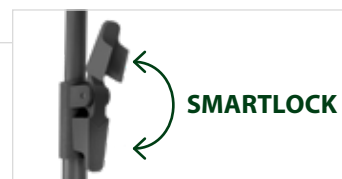

Gambe regolabili senza scatti

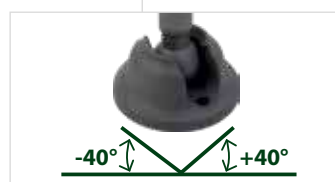

Piedino di livellamento con snodo



Dispositivo di bloccaggio gambe tavolo



LINEAR 100

Art. 0406038N.C69

€ 119,90

🔒 100 x 68 x H63/83 cm

🔒 100 x 68 x 7 cm

📦 8,3 kg



LINEAR 115

Art. 0406031N.C69

€ 139,90

🔒 115 x 70 x H63/83 cm

🔒 115 x 70 x 8 cm

📦 12,7 kg



DRINKMASTER

Art. 0404061N.C9N

€ 7,50

📏 20 x 18 cm

📦 226 g

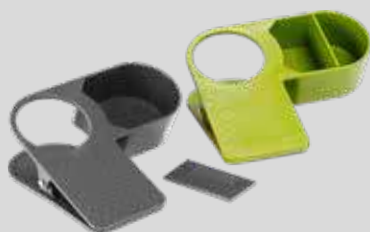

DRINKMASTER S

Art. 0404029N.C9N

€ 6,90

📏 20 x 10 cm

📦 170 g

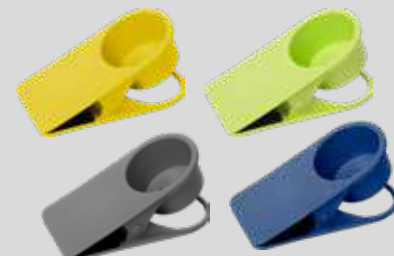

Drinkmaster - il portabevande intelligente per il campeggio, il camper, il caravan, la nautica ed il giardino. Viene agganciato lateralmente al tavolo e garantisce un appoggio sicuro a bicchieri, lattine e svariati piccoli accessori.

Pratico supporto portabevande realizzato in materiale plastico di ottima qualità. Costruito come un morsetto gigante, il Drinkmaster può essere fissato rapidamente a qualsiasi tavolo o a qualsiasi supporto piano. Le 2 pinze rivestite di materiale antisdrucciolo garantiscono un'ottima presa su quasi tutte le superfici.



RECREO

GREY



Il tavolo Recreo per Outdoor e Camping si distingue per la sua eccezionale stabilità e qualità e per il suo design innovativo ed elegante. Dotato di una speciale struttura in alluminio con guida centrale brevettata e di un solido ripiano Sevelit, conosciuto in tutto il mondo per la sua resistenza agli agenti atmosferici ed alle sollecitazioni meccaniche. L'utilizzo di raccordi e giunti in materiale plastico di alta qualità abbinato ad un processo di produzione professionale ha creato un modello di tavolo ideale per affrontare la vita all'aperto per molti anni. Disponibile in 2 misure.

CARATTERISTICHE:

- Uso versatile, indoor/outdoor
- Alta resistenza ai raggi UV, alle intemperie ed al calore (pentole, sigarette)
- Ripiano Sevelit con bordo di protezione perimetrale
- Eccezionale resistenza ai graffi ed alle sollecitazioni meccaniche
- Facile da pulire
- Montaggio semplice e rapido
- Regolabile in altezza senza scatti

<M>
mountless
 the smart
 folding system



RECREO 80

Art. 0406110N

€ 146,90

80 x 60 x H70 cm

80 x 60 x 7 cm

5,9 kg

RECREO 100

Art. 0406111N

€ 179,90

100 x 68 x H70 cm

100 x 68 x 7 cm

6,1 kg

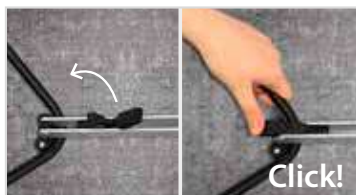
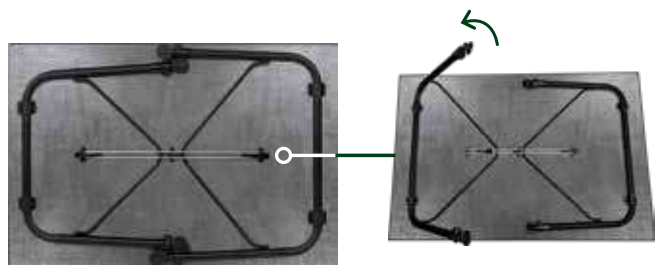

PATENTED

Click!



STORACK 80

Art. 0406121N

€ 15,90

80 x 60 x H13 cm

100% Polyester

STORACK 100

Art. 0406122N

€ 16,90

100 x 72 x H13 cm

100% Polyester

Pratico ripiano supplementare in rete per tavoli a 4 gambe verticali. Costruzione regolabile in lunghezza. Facilissimo da applicare mediante cinghiette munite di nastro Velcro. Completo di sacchetto custodia. Disponibile in 2 misure.

TABYLO EXTERIO

GRANITE

Tavolo da camping ed outdoor di alta qualità, dotato del nuovissimo ripiano superleggero Exteriolit della Severin. Massima stabilità grazie al telaio in alluminio brevettato ed abbinato al rivoluzionario sistema di livellamento Adjustar.



<M>
mountless
the smart
folding system

superlight



protection film
decorative layer
core layers impregnated
with phenolic resin

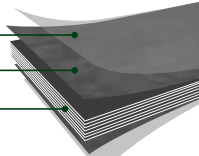

TABYLO EXTERIO 100

Art. 0406020N

€ 271,90

🔒 100 x 68 x H50,5/75 cm

🔒 100 x 68 x 11 cm

🔒 7,40 kg

TABYLO EXTERIO 120

Art. 0406021N

€ 294,90

🔒 120 x 68 x H50,5/75 cm

🔒 120 x 68 x 11 cm

🔒 8,90 kg

INFO p. 191



ADJUSTAR
LEVELLING SYSTEM

BRUNER ▶

4X

3,5 cm

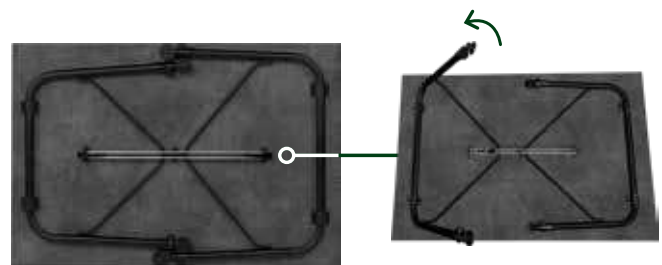
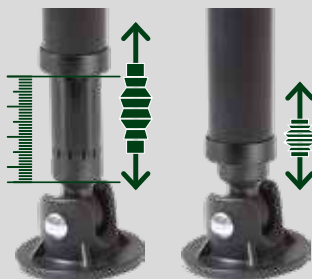

PATENTED

Click!

PATENTED



ultralight

ELÙ

BLACK MARBLE



ELÙ 100

Art. 0406058N

€ 199,90

- 100 x 70 x H50,5/70 cm
- 100 x 70 x 11 cm
- 4,6 kg

ELÙ 120

Art. 0406055N

€ 237,90

- 120 x 80 x H50,5/70 cm
- 120 x 80 x 11 cm
- 5,6 kg

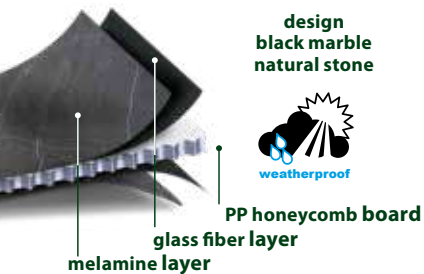

Tavolo da campeggio e da esterno di prima qualità con meccanismo di ripiegamento di nuova concezione e piano ultraleggero. Grazie ad un binario di scorrimento centrale, il robusto telaio del tavolo può essere montato e smontato in pochi secondi e senza difficoltà.

CARATTERISTICHE:

- Piano di lavoro: Costruzione ultraleggera, resistente alle intemperie e al calore
- Telaio: in alluminio con esclusivo meccanismo di chiusura
- Gambe del tavolo: alluminio anodizzato color nero ø 28/25 mm, regolabili in altezza senza scatti

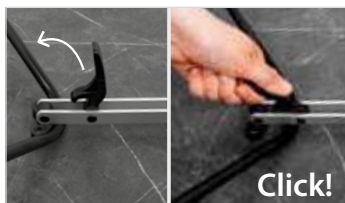

TAVOLI

ELÙ DUPLIT

BLACK MARBLE



ultralight



<M>
mountless

LOCK-OPEN



1

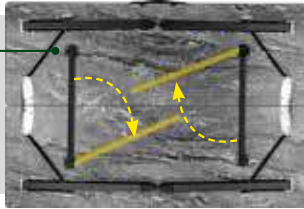

2

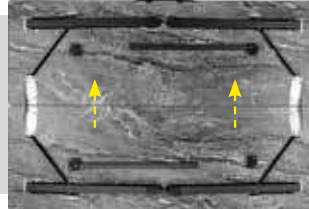

ELÙ DUPLIT

Art. 0406050N

€ 239,90

110 x 75 x H49/58/70 cm

110 x 37,5 x 9 cm

4,90 kg

Tavolo ultraleggero molto stabile con piano pieghevole centralmente e funzionale telaio in alluminio. La costruzione speciale permette alla struttura regolabile in altezza e poco ingombrante di essere ripiegata facilmente sul lato inferiore del tavolo ed aumenta anche lo spazio per le gambe su tutti e 4 i lati. Il piano del tavolo, multistrato e resistente alle intemperie, ha una speciale struttura a nido d'ape senza bordo di scorrimento tutto intorno per permettere all'acqua di defluire. Si piega e si ripone in modo molto compatto. Con maniglia per il trasporto.



4x



MAX
2 cm



AZABACHE

SQUARE



AZABACHE CT SQUARE

Art. 0422085N.C03

- 85 x 52 x H90 cm
- 86 x 14 x 49 cm
- 9 kg

Mobiletto cucina di nuova concezione con 2 scomparti multifunzionali separati. Piano di lavoro arrotolabile alto in alluminio.

CARATTERISTICHE:

- Telaio quadrato di nuova concezione per una maggiore stabilità
- Gambe regolabili in altezza per adattarsi a terreni irregolari
- Rivestimento in poliestere resistente
- Zanzariera di aerazione nella parete posteriore
- Completo di paravento
- Con sacca custodia

LEVEL SYSTEM

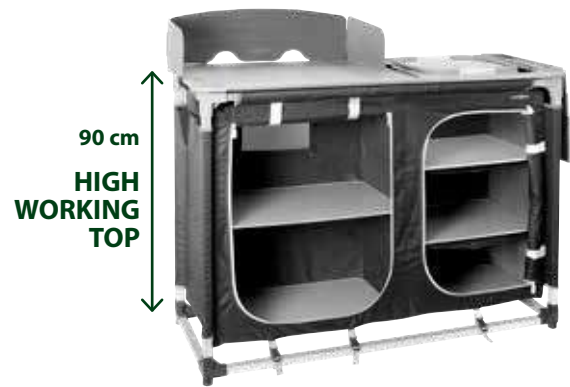
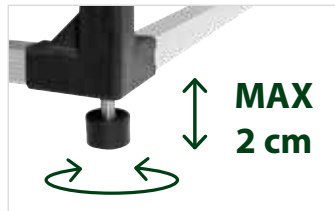

AZABACHE CTW SQUARE HWT

Art. 0422086N.C03

€ 227,90

- 110 x 48 x H90/118 cm
- 120 x 49 x 15 cm
- 11 kg

Pratica cucina da campeggio con lavello pieghevole integrato e rimovibile e 2 grandi vani portaoggetti con tanto spazio per il cibo e gli utensili da cucina. Con piano arrotolabile in alluminio di grandi dimensioni e gambe regolabili in altezza. Struttura estremamente stabile grazie all'impiego di profili rettangolari resistenti alla torsione. Montaggio semplice e veloce. Altezza di lavoro: 90 cm. La fornitura include un paravento ed un paraspruzzi, oltre ad una pratica borsa per il trasporto.

CARATTERISTICHE:

- Struttura in alluminio
- Tessuto: 100% poliestere spalmato
- Scomparti: 2 vani portaoggetti separati con cerniera (5 ripiani)

INCLUDED



CLEO
FOLD-AWAY

AZABACHE LS

Art. 0422081N.C03

€ 109,90



- 59 x 48 x H104 cm
- 42 x 11 x 53 cm
- 5,2 kg

Armadio funzionale in alluminio con ripiani interni.

AZABACHE HS

Art. 0422082N.C03

€ 124,90



- 59 x 48 x H140 cm
- 42 x 11 x 69 cm
- 6,3 kg

Armadio funzionale in alluminio grande con ripiani interni.

AZABACHE

CROSS SQUARE

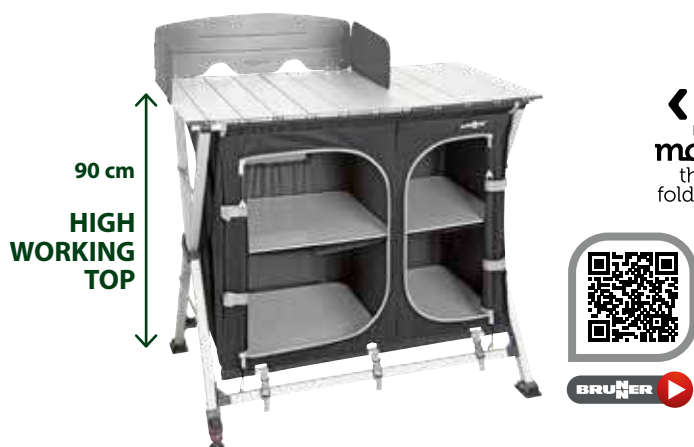

AZABACHE CT CROSS SQUARE

Art. 0422088N.C03

€ 189,90

99 x 51 x H90/115 cm

102 x 13 x 59 cm

8,9 kg

Armadio multifunzionale di nuova concezione con struttura CROSS in tubolare di alluminio. 1 piedino regolabile in altezza, orientabili e di dimensioni tali da evitare l'affondamento in terreni morbidi. Dotato di 2 scomparti separati e ripiano di lavoro in alluminio resistente (sistema Gapless) con livella integrata.

CARATTERISTICHE:

- Telaio quadrato di nuova concezione per una maggiore stabilità
- Piano di lavoro alto
- Rivestimento in poliestere resistente
- Zanzariera di aerazione nella parete posteriore
- Completo di paravento
- Con sacca custodia



Grande armadio multifunzionale con 2 scomparti separati con cerniera e 6 ripiani interni. Lo scomparto più stretto può essere trasformato in armadio grazie ai ripiani divisibili e alla barra pensile integrata. Struttura molto robusta con telaio trasversale in alluminio e profili rettangolari resistenti alla torsione. Le pareti anteriori e posteriori possono essere ulteriormente stabilizzate tramite uno speciale dispositivo di tensionamento. I piedini di appoggio impediscono che l'armadio sprofondi in un terreno soffice o rovini il pavimento della tenda o la moquette. Il piedino regolabile in altezza consente una perfetta compensazione del livello su terreni irregolari. Una finestra in zanzariera nella parete posteriore fornisce la ventilazione interna all'armadio.

CARATTERISTICHE:

- Struttura: Alluminio
- Tessuto: 100% poliestere spalmato
- Con borsa



AZABACHE LS CROSS SQUARE

Art. 0422089N.C03

€ 134,90

58 x 49 x H90 cm

62 x 12 x 61 cm

7,3 kg

Armadio multifunzionale di nuova concezione con struttura CROSS in tubolare di alluminio. 1 piedino regolabile in altezza, orientabili e di dimensioni tali da evitare l'affondamento in terreni morbidi. Dotato di grande scomparto e ripiano di lavoro in MDF rinforzato.

CARATTERISTICHE:

- Telaio quadrato di nuova concezione per una maggiore stabilità
- Rivestimento in poliestere resistente
- Zanzariera di aerazione nella parete posteriore
- Con sacca custodia



AZABACHE HSC CROSS SQUARE

Art. 0422090N.C03

€ 217,90

70 x 59 x H125 cm

72 x 17 x 92 cm

8 kg



AZABACHE

DAILY



<M>
mountless
the smart
folding system



AZABACHE DAILY MP

Art. 0422083N.C06

€ 159,90

60 x 51 x H84 cm

64 x 56 x 11 cm

6,3 kg

Mobiletto box di alta qualità con robusto telaio pieghevole in profilato di alluminio.

CARATTERISTICHE:

- Zanzariera di aerazione nella parete posteriore
- Piedini regolabili in altezza
- Con maniglia per il trasporto
- Con sacca custodia



AZABACHE DAILY CT

Art. 0422084N.C06

€ 219,90

102 x 50,5 x H84 cm

105 x 53 x 9 cm

9,3 kg



AZABACHE CUBE

Art. 0422091N.C06

€ 199,90

65 x 45 x H58/81 cm

65 x 15 x H45 cm

9,7 kg



Mobiletto cucina pieghevole portatile con nuovissima struttura salvaspazio Mountless in alluminio. Si apre e chiude in pochissimo tempo. Piano di cottura in bambù. Completo di armadietto in tessuto per riporre tutti gli accessori per cucinare. Di dimensioni molto compatte quando ripiegato e quindi ideale per tutti gli amanti di minibus, van e camper furgonati. Completo di sacca custodia.

CARATTERISTICHE:

- Struttura Mountless pieghevole in profilo rettangolare di alluminio
- Piedini regolabili in altezza
- Ripiano in MDF con bordo perimetrale in metallo
- Armadietto tessile a 2 ripiani in resistente tessuto di poliestere spalmato
- Con paravento/paraspruzzi in metallo
- Completo di sacca custodia

MERCURY

CROSS SQUARE

C06

<M>
mountless
the smart
folding system



MERCURY CROSS LS SQ

Art. 0422050N.C06

€ 159,90

60 x 49 x H100 cm

62 x 11 x 61 cm

8,4 kg

Stabile armadietto multiuso con struttura CROSS realizzata in profilato rettangolare di alluminio e snodo centrale in metallo. Tutti i piedini sono regolabili in altezza. Con 3 ripiani interni ed un piano di lavoro in bambù. Sistema Mountless. Con custodia per il trasporto.



MERCURY CROSS COOKER HWT SQ

Art. 0422054N.C06

€ 209,90

92 x 49 x H90 cm

93,5 x 11 x H57 cm

10,9 kg

90 cm
HIGH
WORKING
TOP



Pratico mobiletto cucina con struttura CROSS realizzata in profilato rettangolare di alluminio e snodo centrale in metallo. Tutti i piedini sono regolabili in altezza. Con 2 ripiani interni ed un piano di lavoro in bambù. Sistema Mountless. Con paravento e custodia per il trasporto.



MERCURY CROSS HS SQ

Art. 0422055N.C06

€ 199,90

60 x 49 x H140 cm

76,5 x 11 x 63 cm

9,3 kg

Stabile armadietto multiuso con struttura CROSS realizzata in profilato rettangolare di alluminio e snodo centrale in metallo. Tutti i piedini sono regolabili in altezza. Con 4 ripiani interni ed un piano di lavoro in bambù. Sistema Mountless. Con custodia per il trasporto.



space saver

LATIGA

Art. 0422098N

€ 95,90

49 x 33 x H109 cm

49 x 9,5 x H109 cm

4,3 kg



<M>
mountless

Riponitutto per camping e Outdoor con telaio pieghevole in alluminio e 3 cestini inclinabili di diverse dimensioni. Perfetto per mantenere in ordine la vostra tenda/veranda. Può essere ripiegato dopo l'uso per risparmiare spazio.





RAZOR CT

ULTRALIGHT



RAZOR ULTRALIGHT CT

Art. 0422003N

€ 179,90

80 x 46 x H82 cm

84 x 38,5 x 37,5 cm

5,9 kg



Mobiletto cucina Outdoor ultraleggero con robusta struttura in alluminio ed elegante piastra di copertura in alluminio arrotolabile con listelli terminali in bambù. L'ampio armadio in tessuto diviso centralmente con 2 ripiani per ciascun scomparto e con rivestimento interno di colore chiaro, offre molto spazio per riporre cibi e stoviglie. Tutte e 4 le gambe sono regolabili in altezza. Montaggio e smontaggio semplici e intuitivi. Dimensioni molto compatte quando ripiegato.

CARATTERISTICHE:

- Armadio in 100% poliestere con rivestimento interno di colore chiaro
- Gambe regolabili in altezza
- Comprende una pratica borsa per il trasporto



WINWALL

Art. 0426011N

€ 39,90

63,5 x 31 x H25,5 cm

63,5 x 31 x H1 cm

2,20 kg

Paravento per piano cottura con base resistente al calore. Tutti gli elementi sono pieghevoli e realizzati in metallo verniciato a polveri. Per fornelli a 2 e 3 fuochi.



HANGAR 3

Art. 0420072N.C03

€ 16,90

60 x 21 cm

100% Polyester

HANGAR 2

Art. 0420073N.C03

€ 13,90

40 x 21 cm

Pratica tasca portaoggetti con 2/3 tasche.

HANGAR 6

Art. 0420071N.C03

€ 31,90

90 x 30 cm

100% Polyester

Pratica tasca portaoggetti con 6 tasche ed un grande specchio.



RAZOR LS

ULTRALIGHT



RAZOR ULTRALIGHT LS

Art. 0422004N

€ 169,90

60 x 46 x H82 cm

66 x 35 x 29 cm

5,2 kg



Armadio multifunzionale ultraleggero per Outdoor con robusto telaio ad innesto in alluminio. Montaggio e smontaggio semplici e intuitivi. Elegante piano di copertura in alluminio arrotolabile con listelli terminali in bambù. L'ampio pensile in tessuto con 4 ripiani e rivestimento interno chiaro offre un abbondante spazio di stivaggio per tutti i tipi di articoli necessari per la vita in camper. Tutte e 4 le gambe sono regolabili in altezza. Dimensioni compatte dell'imballaggio.

CARATTERISTICHE:

- Armadio in 100% poliestere con rivestimento interno chiaro
- Gambe regolabili in altezza
- Include una pratica borsa per il trasporto



HANKY

Art. 0424007N

€ 47,90

40,5 x 20 x H75 cm

800 g

100% PES

Armadietto pensile dotato di 3 mensole interne e 4 tasche esterne. Porta in zanzariera con apertura centrale a cerniera.

HANGAR 12

Art. 0420070N.C03

€ 23,90

74 x 39 cm

100% Polyester

Pratica tasca portaoggetti con 12 tasche.



HANGAR 10S

Art. 0420075N.C06

€ 45,90

50 x 80 cm

100% Polyester

Soluzione comoda ed elegante per riporre scarpe, sandali e altri oggetti. In totale sono disponibili 10 tasche copribili per l'organizzazione dello spazio di stivaggio del veicolo. Utilizzabile sia all'interno che all'esterno.





CHUCK BOX NG

Art. 0426079N.C03

€ 194,90

90 x 50 x H82 cm

92 x 51 x 13 cm

6,5 kg



Mobiletto cucina con struttura in alluminio molto resistente ed un grande piano di lavoro in MDF con bordatura perimetrale in alluminio. L'intero mobiletto trova posto nella borsa di trasporto inclusa. Facile da montare e smontare. L'ampio mobile con chiusura a cerniera offre spazio per riporre alimenti e accessori per la cucina. Include un supporto laterale pieghevole per un lavello collassabile.

CARATTERISTICHE:

- Telaio con gambe pieghevoli
- Pensile con base a griglia in acciaio
- Piedini regolabili in altezza
- Include un paravento ed un paraspruzzi in metallo

OPTIONAL

**CLEO
FOLD-AWAY
p. 308**

not included



DRIVE IN BLACK

Art. 0426032N.C03

€ 254,90

100 x 50 x H78/128,5 cm

100 x 50 x 14,5 cm

11,9 kg



Mobiletto cucina ideale per l'utilizzo Outdoor.

CARATTERISTICHE:

- Ripiano di lavoro in MDF con bordo in alluminio
- Gambe in profilo di acciaio
- Mobiletto pensile a 2 scomparti
- Lavello in plastica
- Robuste maniglie per il trasporto
- Sacca custodia

KITCHENETTE

Art. 0422097N.C03

€ 134,90

67 x 50 x H93,5 cm

67 x 67,5 x 10,5 cm

7,9 kg



Mobiletto cucina compatto e pieghevole con piano di lavoro resistente al calore, abbondante spazio di stivaggio, tasche laterali per gli utensili ed un pratico paravento/paraspruzzi in metallo. Ideale per tende e verande di caravan e minibus di dimensioni compatte. Con pratica borsa per il trasporto.





SNACK BASIC

Art. 0422095N.C03

€ 114,90

 62 x 46 x H90/109 cm

 82 x 50 x 13 cm

 5,5 kg

REMOVABLE



Mobiletto cucina da campeggio pieghevole con piano di lavoro arrotolabile, ripiano inferiore con armadio in tessuto rimovibile e utile paravento e paraspruzzi. Un piedino è regolabile in altezza. Veloce e facile da montare e smontare. Molto compatto quando chiuso e quindi facile da riporre. Completo di robusta borsa per il trasporto.

CARATTERISTICHE:

- Telaio in metallo, verniciato a polvere
- Ripiano arrotolabile in alluminio
- Tessuto in 100% poliestere spalmato



OPTIONAL

PILLAR not included
p. 315

SNACK SQUARE

Art. 0422096N.C03

€ 187,90

 120 x 52 x H90/109 cm

 82 x 52 x 15 cm

 8,2 kg



Mobiletto cucina di nuova concezione con struttura pieghevole extra stabile in profilo quadrato di alluminio. 2 armadi separati offrono ampio spazio per riporre cibo e utensili da cucina. La fornitura include un paravento ed un paraspruzzi, oltre ad una pratica borsa per il trasporto.

CARATTERISTICHE:

- Ripiano arrotolabile: alluminio
- Armadi in 100% poliestere spalmato con porta a cerniera
- Altezza di lavoro: 90 cm (cucina standard)





SNACK EASY BLACK

Art. 0426034N.C03

€ 179,90

 141 x 50 x H80,5 cm

 80 x 51 x 12 cm

 7,8 kg



Combinazione molto pratica di cucina da campo e mobile portastoviglie.

CARATTERISTICHE:

- Struttura in alluminio Ø 19/22 mm
- Ripiano laterale in MDF bordato in alluminio
- Mobiletto pensile in 100% poliestere con ripiani interni in MDF
- Facile da ripiegare
- Sacca di trasporto inclusa



MEPO BOX
Ready

OPTIONAL





TABLE AND KITCHEN



**STOVIGLIE OUTDOOR
POPOTE**

TABLEWARE

COLLECTION

220

STONEtouch®

DOLOMIT • ODETTE • TUSCANY • GRANADA • SAVANA
BELLAGIO • AMALFI • VENETIAN • PEARL • METEORE • AMADÈ

233

PREMIUM CLASSIC

COTTERY • KASSANDRA • TIVOLI • GRANYTE
SANDHYA • SPACE • SPECTRUM • SPHERICA

243

SEVEN SEAS

NAUTICAL • BLUE OCEAN

246

ALLROUND

DEEP SEA • COSMIC • SERENADE • PRALIN

250

SQUARE

KHADI • PANAREA • ENIGMA

252

FLASH

SEQUOIA • BREEZE • ASTRALYS • BLUE BAY • TULIP • ESPRIT

256

LIVING

BBGRILL • SOUP BOWL • PASTA & SALAD • PIZZA
CHEESE SET

258

KIDS

ICE CREAM • JUNGLE PARADE • AROUND THE WORLD
BUTTERFLY • FARM • TIME TO TRAVEL • MOLLY • JACK
LET'S GO ADVENTURE

264

GLASSWARE



TABLETOP & ENTERTAINING

Gli articoli sono prodotti con la migliore melamina, composto ottenuto dalla combinazione di resine melaminiche e cellulosa che rende particolare questo materiale in quanto rigido e molto leggero.

BRUNNER MELAMINE:
100% BPA-FREE

BPA free



originaldesign



• Resistente al calore ed all'umidità

• Inodore ed insapore

• Facile da pulire

• Ottima resistenza agli urti

• Utilizzabile nel congelatore

• Lunga durata

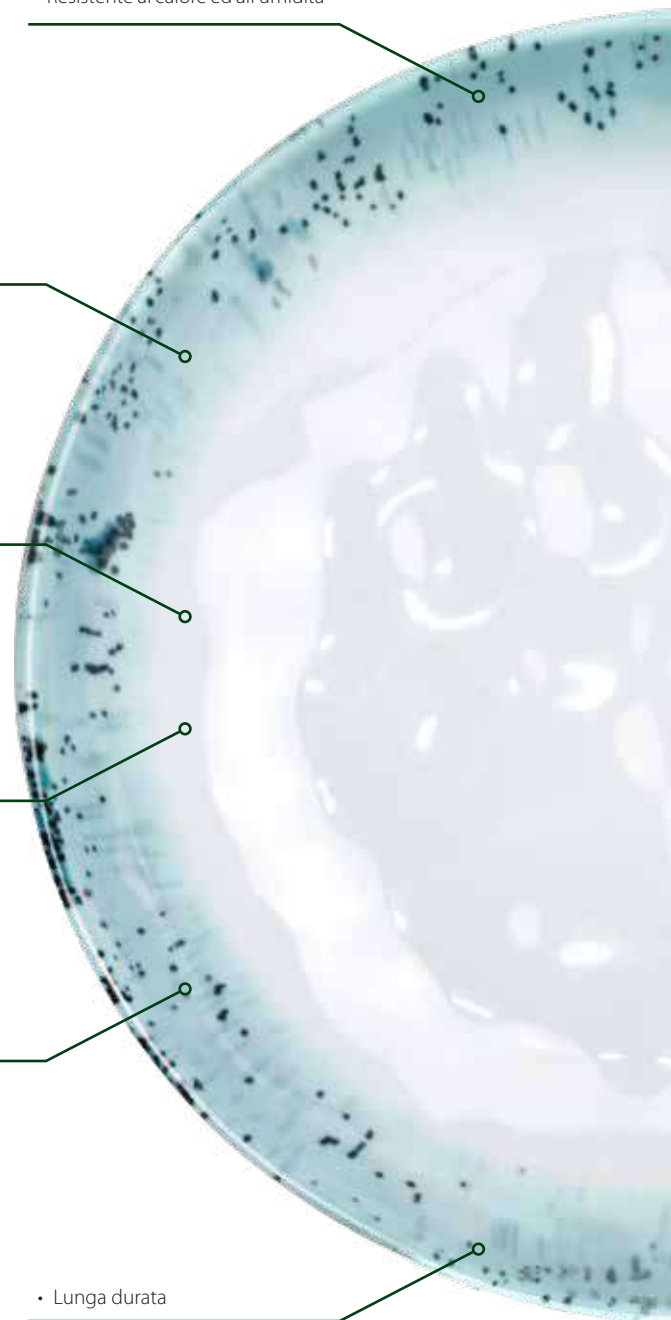

INFO

STONEtouch®

Nuovo materiale ottenuto da una combinazione di melamina/polvere minerale con eccellenti proprietà funzionali:

- Superficie dura
- Stabilità dimensionale
- Brilla come la porcellana
- Al tocco sembra porcellana
- Adatto per alimenti
- Igienico, facile da pulire
- Inodore e insapore
- Congelabile
- Lavabile in lavastoviglie
- Resistente alla rottura
- Lunga durata



STONE
touch
dinnerware

IMPROVED SURFACE



BRUNER

NOISE
REDUCTION

**ANTI
SLIP**

ANTISLIP

NOISE REDUCTION

Mediante l'utilizzo di una guarnizione in gomma integrata nel fondo delle stoviglie viene data maggiore stabilità. Infatti vengono quasi azzerate le possibilità di scivolamento e caduta e inoltre viene notevolmente ridotto il fastidioso tintinnio nel caso di spostamenti.





HOT MUG

BPA free

HEAT RESISTANT

Resylin è un materiale termoplastico incolore su base ABS (acrilonitrile-butadiene-stirene), nel quale si fondono buone caratteristiche meccaniche ed una buona resistenza chimica.

VANTAGGI:

- 100% senza BPA e adatto all'uso alimentare
- Ottime proprietà isolanti
- Riciclabile
- Resistente alla corrosione e abrasione
- Utilizzabile fino a 90°C (per breve tempo anche a 100°C)
- Ottima resistenza agli urti (anche a basse temperature)
- Utilizzabile nel congelatore



SPACE SAVER

COMPACT STORAGE



VIP STORAGE SYSTEM

SPACE ORGANIZING



VIP
STORAGE
box

COMES WITH
ALL INCLUSIVE VIP
STONETOUCH
COLLECTION



DOLOMIT

PREMIUM CLASSIC



STONEtouch®

Piatto piano ø 25 cm

Art. 0830025N € 12,50



C00



C43



C28



C20

Piatto fondo ø 20 cm

Art. 0830026N € 9,90



C00



C43



C28



C20

Scodella ø 16 cm

Art. 0830043N € 8,50



C00



C43



C28



C20

Piatto dessert ø 20 cm

Art. 0830027N € 8,50



C00



C43



C28



C20

Portauovo

Art. 0830032N € 4,90



C00



C43



C28



C20

Tazzone 30 cl

Art. 0830051N € 7,50



C00



C43



C28



C20

Bicchieri 30 cl

Art. 0830214S € 9,50



C00



C43



C28



C20

Insalatiera ø 25 cm

Art. 0830030N € 17,90



C00



C43



C28



C20

ONDA

Art. 0830214N

€ 22,90

300 ml

PACK 4X



ONDA & JAZZ WINEGLASS

Art. 0830184C.C9N

€ 39,90

60 cl

PACK 4X





MIDDAY DOLOMIT

Art. 0830148N.C2P

€ 119,90

PCS. 12

-  4 x Ø 16 cm
-  4 x Ø 20 cm
-  4 x Ø 25 cm



MUG SET DOLOMIT

Art. 0830051C.C2P

€ 29,90

PCS. 4







LUNCH BOX DOLOMIT

Art. 0830155N.C2P

€ 129,90

PCS. 16

-  4 x Ø 20 cm
-  4 x Ø 20 cm
-  4 x Ø 25 cm
-  4 x 30 cl









ALL INCLUSIVE DOLOMIT

Art. 0830154N.C2P

€ 179,90

PCS. 36

-  4 x Ø 20 cm
-  4 x Ø 20 cm
-  4 x Ø 25 cm
-  4 x 30 cl
-  4 x 20 cl
-  16 pcs





Piatto piano ø 25 cm

Art. 0830025N.C3A € 9,90



Piatto fondo ø 23 cm

Art. 0830026N.C3A € 10,90



Piatto dessert ø 19 cm

Art. 0830027N.C3A € 8,30



Tazzina espresso

Art. 0830048N.C3A € 8,90



Scodella ø 15 cm

Art. 0830043N.C3A € 9,90



Insalatiera ø 25 cm

Art. 0830030N.C3A € 18,90



Portauovo

Art. 0830032N.C3A € 4,90



ODETTE

STONEtouch®



**NEW
2023**

MIDDAY ODETTE

Art. 0830148N.C3A

PCS. 12

€ 93,50

	4 x Ø 15 cm
	4 x Ø 19 cm
	4 x Ø 25 cm



LUNCH BOX ODETTE

Art. 0830155N.C3A

PCS. 16

€ 119,50

	4 x Ø 23 cm
	4 x Ø 19 cm
	4 x Ø 25 cm
	4 x 30 cl



Tazzone 30 cl

Art. 0830051N.C3A € 7,50









6 IN 1 ODETTTE

Art. 0830137N.C3A

PCS. 7

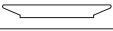
€ 68,90

	2 x Ø 23 cm
	2 x Ø 19 cm
	2 x Ø 25 cm
	1 x Ø 25 cm



Il set 6 in 1 è il risultato della nostra ricerca di una soluzione elegante, funzionale e salvaspazio da utilizzare per ogni viaggio, per il camping o per picnic all'aria aperta. Realizzato in melamina Stonetouch di alta qualità, è composto da ben 7 pezzi: 2 piatti piani, 2 piatti fondi, 2 piatti dessert più una capiente ciotola per insalata che contiene l'intero set, occupando veramente pochissimo spazio.

Tutti gli elementi del set 6 in 1 convincono con le seguenti caratteristiche:

- Realizzati in speciale melamina Stonetouch alimentare
- Effetto porcellana
- Resistenti agli urti
- Completi di anello Antislip
- Impilabili
- Lavabili in lavastoviglie
- Senza BPA





TÊTE-Â-TÊTE TUSCANY

Art. 0830143N.C5T

€ 63,50

PCS. 8



	2 x Ø 21 cm		2 x Ø 26 cm
	2 x Ø 15 cm		2 x 30 cl

MIDDAY TUSCANY

Art. 0830148N.C5T

€ 89,90

PCS. 12



	4 x Ø 15 cm		4 x Ø 26 cm
	4 x Ø 21 cm		

LUNCH BOX TUSCANY

Art. 0830155N.C5T

€ 108,90

PCS. 16



	4 x Ø 21 cm		4 x Ø 26 cm
	4 x Ø 21 cm		4 x 30 cl

ALL INCLUSIVE TUSCANY

Art. 0830154N.C5T

€ 172,50

PCS. 36



	4 x Ø 21 cm		4 x Ø 26 cm
	4 x Ø 21 cm		4 x 30 cl
	4 x 20 cl		16 pcs



TUSCANY

STONEtouch®

Piatto piano ø 26 cm

Art. 0830025N.C5T

€ 9,90



Piatto fondo ø 21 cm

Art. 0830026N.C5T

€ 8,90



Piatto dessert ø 21 cm

Art. 0830027N.C5T

€ 8,30



Tazzone 30 cl

Art. 0830051N.C5T

€ 7,50



Scodella ø 15 cm

Art. 0830043N.C5T

€ 9,90



Insalatiera ø 30 cm

Art. 0830030N.C5T

€ 17,90



Portauovo

Art. 0830032N.C5T

€ 4,90



Bicchiere 25 cl

Art. 0830090N.C48

€ 5,90



Burriera 13,5 x 9,5 x H6,5 cm

Art. 0830099N.C48

€ 11,50



Set zuppiera 1x 55 cl / 1x 24x18 cm

Art. 0830049N.C5T

€ 23,50



Ciotola ovale 33x23xH7 cm

Art. 0830067N.C5T

€ 28,50



Piatti da portata 40x28 cm / 35x25 cm

Art. 0830069N.C5T

€ 34,50



ALL INCLUSIVE VIP TUSCANY

Art. 0830150N.C5T

€ 196,90

PCS. 40

	4 x Ø 21 cm
	4 x Ø 21 cm
	4 x Ø 26 cm
	4 x Ø 15 cm
	4 x 30 cl
	4 x 20 cl
	16 pcs



TÊTE-À-TÊTE GRANADA

Art. 0830143N.C3S

€ 63,50

PCS. 8



	2 x Ø 21 cm		2 x Ø 26 cm
	2 x Ø 15 cm		2 x 30 cl

MIDDAY GRANADA

Art. 0830148N.C3S

€ 89,90

PCS. 12



	4 x Ø 15 cm		4 x Ø 26 cm
	4 x Ø 21 cm		

LUNCH BOX GRANADA

Art. 0830155N.C3S

€ 108,90

PCS. 16



	4 x Ø 21 cm		4 x Ø 26 cm
	4 x Ø 21 cm		4 x 30 cl

ALL INCLUSIVE GRANADA

Art. 0830154N.C3S

€ 172,50

PCS. 36



	4 x Ø 21 cm		4 x Ø 26 cm
	4 x Ø 21 cm		4 x 30 cl
	4 x 20 cl		16 pcs

Piatto piano ø 26 cm

Art. 0830025N.C3S

€ 9,90

**Piatto dessert ø 21 cm**

Art. 0830027N.C3S

€ 8,30

**Scodella ø 15 cm**

Art. 0830043N.C3S

€ 9,90

**Portauovo**

Art. 0830032N.C3S

€ 4,90

**Burriera 13,5 x 9,5 x H6,5 cm**

Art. 0830099N.C1M

€ 11,50

**Ciotola ovale 33x23xH7 cm**

Art. 0830067N.C3S

€ 28,50

**Piatto fondo ø 21 cm**

Art. 0830026N.C3S

€ 8,90

**Tazzone 30 cl**

Art. 0830051N.C1M

€ 7,50

**Insalatiera ø 30 cm**

Art. 0830030N.C3S

€ 17,90

**Bicchiere 25 cl**

Art. 0830090N.C1M

€ 5,90

**Set zuppiera 1x 55 cl / 1x 24x18 cm**

Art. 0830049N.C3S

€ 23,50

**Piatti da portata 40x28 cm / 35x25 cm**

Art. 0830069N.C3S

€ 34,50

**ALL INCLUSIVE VIP GRANADA**

Art. 0830150N.C3S

PCS. 40

	4 x Ø 21 cm
	4 x Ø 21 cm
	4 x Ø 26 cm
	4 x Ø 15 cm
	4 x 30 cl
	4 x 20 cl
	16 pcs



€ 196,90

**GRANADA**
STONEtouch®



SAVANA

STONEtouch®



Piatto piano ø 26 cm

Art. 0830025N.C4P € 9,90



Piatto fondo ø 21 cm

Art. 0830026N.C4P € 8,90



Piatto dessert ø 21 cm

Art. 0830027N.C4P € 8,30



Tazzone 30 cl

Art. 0830051N.C1C € 7,50



Scodella ø 15 cm

Art. 0830043N.C4P € 9,90



Insalatiera ø 30 cm

Art. 0830030N.C4P € 17,90



Portauovo

Art. 0830032N.C4P € 4,90



Bicchieri 25 cl

Art. 0830090N.C71 € 5,90



Burriera 13,5 x 9,5 x H6,5 cm

Art. 0830099N.C4P € 11,50



Set zuppiera 1x 55 cl / 1x 24x18 cm

Art. 0830049N.C4P € 23,50



Ciotola ovale 33x23xH7 cm

Art. 0830067N.C4P € 28,50



Piatti da portata 40x28 cm / 35x25 cm

Art. 0830069N.C4P € 34,50



ALL INCLUSIVE VIP SAVANA

Art. 0830150N.C4P

PCS. 40

4 x ø 21 cm

4 x ø 21 cm

4 x ø 26 cm

4 x ø 15 cm

4 x 30 cl

4 x 20 cl

16 pcs

VIP
box



€ 196,90



TÊTE-Â-TÊTE SAVANA

Art. 0830143N.C4P

€ 63,50

PCS. 8



2 x ø 21 cm

2 x ø 15 cm

2 x ø 26 cm

2 x 30 cl

MIDDAY SAVANA

Art. 0830148N.C4P

€ 89,90

PCS. 12



4 x ø 15 cm

4 x ø 21 cm

4 x ø 26 cm

LUNCH BOX SAVANA

Art. 0830155N.C4P

€ 108,90

PCS. 16



4 x ø 21 cm

4 x ø 21 cm

4 x ø 26 cm

4 x 30 cl

ALL INCLUSIVE SAVANA

Art. 0830154N.C4P

€ 172,50

PCS. 36



4 x ø 21 cm

4 x ø 21 cm

4 x 20 cl

4 x ø 26 cm

4 x 30 cl

16 pcs

BELLAGIO

STONEtouch®

Piatto piano ø 26 cm

Art. 0830025N.C4X € 9,90

**Piatto fondo ø 21 cm**

Art. 0830026N.C4X € 8,90

**Piatto dessert ø 21 cm**

Art. 0830027N.C4X € 8,30

**Tazzone 30 cl**

Art. 0830051N.C06 € 7,50

**Scodella ø 15 cm**

Art. 0830043N.C4X € 9,90

**Insalatiera ø 30 cm**

Art. 0830030N.C4X € 17,90

**Portauovo**

Art. 0830032N.C4X € 4,90

**Bicchieri 25 cl**

Art. 0830090N.C71 € 5,90

**Burriera 13,5 x 9,5 x H6,5 cm**

Art. 0830099N.C06 € 11,50

**Set zuppiera 1x 55 cl / 1x 24x18 cm**

Art. 0830049N.C4X € 23,50

**Ciotola ovale 33x23xH7 cm**

Art. 0830067N.C4X € 28,50

**Piatti da portata 40x28 cm / 35x25 cm**

Art. 0830069N.C4X € 34,50

**ALL INCLUSIVE VIP BELLAGIO**

Art. 0830150N.C4X

PCS. 40

**VIP
BOX**

	4 x Ø 21 cm
	4 x Ø 21 cm
	4 x Ø 26 cm
	4 x Ø 15 cm
	4 x 30 cl
	4 x 20 cl
	16 pcs



€ 196,90

**TÊTE-Â-TÊTE BELLAGIO**

Art. 0830143N.C4X

€ 63,50

PCS. 8



	2 x Ø 21 cm		2 x Ø 26 cm
	2 x Ø 15 cm		2 x 30 cl

MIDDAY BELLAGIO

Art. 0830148N.C4X

€ 89,90

PCS. 12



	4 x Ø 15 cm		4 x Ø 26 cm
	4 x Ø 21 cm		

LUNCH BOX BELLAGIO

Art. 0830155N.C4X

€ 108,90

PCS. 16



	4 x Ø 21 cm		4 x Ø 26 cm
	4 x Ø 21 cm		4 x 30 cl

ALL INCLUSIVE BELLAGIO

Art. 0830154N.C4X

€ 172,50

PCS. 36



	4 x Ø 21 cm		4 x Ø 26 cm
	4 x Ø 21 cm		4 x 30 cl
	4 x 20 cl		16 pcs



AMALFI

STONEtouch®



TÊTE-Â-TÊTE AMALFI

Art. 0830143N.C5E

€ 63,50

PCS. 8



	2 x Ø 21 cm		2 x Ø 25 cm
	2 x Ø 15 cm		2 x 30 cl

MIDDAY AMALFI

Art. 0830148N.C5E

€ 89,90

PCS. 12



	4 x Ø 15 cm		4 x Ø 25 cm
	4 x Ø 21 cm		

LUNCH BOX AMALFI

Art. 0830155N.C5E

€ 108,90

PCS. 16



	4 x Ø 21 cm		4 x Ø 25 cm
	4 x Ø 21 cm		4 x 30 cl

Piatto piano ø 25 cm

Art. 0830025N.C5E

€ 9,90



Piatto fondo ø 21 cm

Art. 0830026N.C5E

€ 8,90



Piatto dessert ø 21 cm

Art. 0830027N.C5E

€ 8,30



Tazzone 30 cl

Art. 0830051N.C48

€ 7,50



Scodella ø 15 cm

Art. 0830043N.C5E

€ 9,90



Insalatiera ø 24 cm

Art. 0830030N.C5E

€ 17,90



Portauovo

Art. 0830032N.C5E

€ 4,90



Bicchiere 30 cl

Art. 0830195S.C08

€ 5,90



POLYCARBONATE
HIGH QUALITY THERMOPLASTIC

ALL INCLUSIVE VIP AMALFI

Art. 0830150N.C5E

PCS. 40

	4 x Ø 21 cm
	4 x Ø 21 cm
	4 x Ø 25 cm
	4 x Ø 15 cm
	4 x 30 cl
	4 x 20 cl
	16 pcs



VIP
STONEtouch
box

€ 196,90



VENETIAN

STONEtouch®



TÊTE-À-TÊTE VENETIAN

Art. 0830143N.C9X

€ 63,50

PCS. 8



	2 x Ø 21 cm		2 x Ø 25 cm
	2 x Ø 18 cm		2 x 30 cl



MIDDAY VENETIAN

Art. 0830148N.C9X

€ 89,90

PCS. 12



	4 x Ø 18 cm		4 x Ø 25 cm
	4 x Ø 21 cm		

LUNCH BOX VENETIAN

Art. 0830155N.C9X

€ 108,90

PCS. 16



	4 x Ø 21 cm		4 x Ø 25 cm
	4 x Ø 21 cm		4 x 30 cl

Piatto piano ø 25 cm

Art. 0830025N.C9X

€ 9,90



Piatto dessert ø 21 cm

Art. 0830027N.C9X

€ 8,30



Scodella ø 18 cm

Art. 0830043N.C9X

€ 9,90



Portauovo

Art. 0830032N.C9X

€ 4,90



Piatto fondo ø 21 cm

Art. 0830026N.C9X

€ 8,90



Tazzone 30 cl

Art. 0830051N.C9X

€ 7,50



Insalatiera ø 28 cm

Art. 0830030N.C9X

€ 17,90



Bicchiere 30 cl

Art. 0830208S.C9X

€ 4,90



ALL INCLUSIVE VIP VENETIAN

Art. 0830150N.C9X

PCS. 40

	4 x Ø 21 cm
	4 x Ø 21 cm
	4 x Ø 25 cm
	4 x Ø 18 cm
	4 x 30 cl
	4 x 20 cl
	16 pcs

VIP
STORAGE
box

€ 196,90

BRUNER



Piatto piano ø 25 cm

Art. 0830025N.C5X € 9,90



Piatto fondo ø 19 cm

Art. 0830026N.C5X € 8,90



Piatto dessert ø 21 cm

Art. 0830027N.C5X € 8,30



Tazzone 30 cl

Art. 0830051N.C06 € 7,50



Scodella ø 18 cm

Art. 0830043N.C5X € 9,90



Insalatiera ø 28 cm

Art. 0830030N.C5X € 17,90



Portauovo

Art. 0830032N.C5X € 4,90



Bicchiere 25 cl

Art. 0830090N.C1M € 5,90



PEARL STONEtouch®



MIDDAY PEARL

Art. 0830148N.C5X

PCS. 12

€ 89,90



	4 x Ø 18 cm
	4 x Ø 21 cm
	4 x Ø 25 cm

TÊTE-Â-TÊTE PEARL

Art. 0830143N.C5X

PCS. 8

€ 63,50



	2 x Ø 19 cm
	2 x Ø 25 cm
	2 x Ø 18 cm
	2 x Ø 18 cm

LUNCH BOX PEARL

Art. 0830155N.C5X

PCS. 16

€ 108,90



	4 x Ø 19 cm
	4 x Ø 21 cm
	4 x Ø 25 cm
	4 x 30 cl

ALL INCLUSIVE VIP PEARL

Art. 0830150N.C5X

PCS. 40

€ 196,90



	4 x Ø 19 cm
	4 x Ø 21 cm
	4 x Ø 25 cm
	4 x Ø 18 cm
	4 x 30 cl
	4 x 20 cl
	16 pcs



Piatto piano ø 25 cm

Art. 0830025N.C1X € 9,90



Piatto fondo ø 21 cm

Art. 0830026N.C1X € 8,50



Piatto dessert ø 20 cm

Art. 0830027N.C1X € 8,30



Tazzone 30 cl

Art. 0830051N.C48 € 7,50



Portauovo

Art. 0830032N.C1X € 4,90



Scodella ø 15 cm

Art. 0830062N.C1X € 8,50



ACRYLIC

Insalatiera ø 24 cm

Art. 0830068N.C1X € 15,50



ACRYLIC

MUG SET

Art. 0830051C.C48 € 25,90

PCS. 4



Set tazzoni in Resylin di alta qualità.

METEORE

STONEtouch®



TÊTE-Â-TÊTE METEORE

Art. 0830143N.C1X

PCS. 8

€ 63,50

	2 x Ø 21 cm
	2 x Ø 25 cm
	2 x Ø 15 cm
	2 x 30 cl



MIDDAY METEORE

Art. 0830148N.C1X

PCS. 12

€ 89,90

	4 x Ø 15 cm
	4 x Ø 20 cm
	4 x Ø 25 cm



ALL INCLUSIVE VIP METEORE

Art. 0830150N.C1X

PCS. 40

VIP
STORAGE
BOX

€ 196,90

	4 x Ø 21 cm
	4 x Ø 20 cm
	4 x Ø 25 cm
	4 x Ø 15 cm
	4 x 30 cl
	4 x 20 cl
	16 pcs



LUNCH BOX METEORE

Art. 0830155N.C1X

PCS. 16

€ 108,90

	4 x Ø 21 cm		4 x Ø 25 cm
	4 x Ø 20 cm		4 x 30 cl





AMADÈ

STONEtouch®



SET WATERGLASS

Art. 0830221N.C71

€ 21,50

✓ 45 cl

PACK 2X



SET WINEGLASS

Art. 0830223N.C71

€ 24,90

✓ 60 cl

PACK 2X



Piatto piano ø 25 cm

Art. 0830025N.C8X

€ 9,90



Piatto fondo ø 20 cm

Art. 0830026N.C8X

€ 8,90



Piatto dessert ø 20 cm

Art. 0830027N.C8X

€ 8,30



Tazzone 30 cl

Art. 0830051N.C1C

€ 7,50



Scodella ø 15 cm

Art. 0830043N.C8X

€ 9,90



Insalatiera ø 30 cm

Art. 0830030N.C8X

€ 17,90



Portauovo

Art. 0830032N.C8X

€ 4,90



MIDDAY AMADÈ

Art. 0830148N.C8X

€ 89,90

PCS. 12

- 4 x Ø 15 cm
- 4 x Ø 20 cm
- 4 x Ø 25 cm



TÊTE-Â-TÊTE AMADÈ

Art. 0830143N.C8X

€ 63,50

PCS. 8

- 2 x Ø 20 cm
- 2 x Ø 25 cm
- 2 x Ø 15 cm
- 2 x 30 cl



LUNCH BOX AMADÈ

Art. 0830155N.C8X

€ 108,90

PCS. 16

- 4 x Ø 20 cm
- 4 x Ø 20 cm
- 4 x Ø 25 cm
- 4 x 30 cl



ALL INCLUSIVE VIP AMADÈ

Art. 0830150N.C8X

€ 196,90

PCS. 40

- 4 x Ø 20 cm
- 4 x Ø 20 cm
- 4 x Ø 25 cm
- 4 x Ø 15 cm
- 4 x 30 cl
- 4 x 20 cl
- 16 pcs



COTTERY

PREMIUM CLASSIC

Piatto piano ø 25 cm

Art. 0830025N.C9B € 9,90



Piatto fondo ø 21 cm

Art. 0830026N.C9B € 9,90



Piatto dessert ø 20 cm

Art. 0830027N.C9B € 8,90



**NEW
2023**



Tazzone 30 cl

Art. 0830035N.C9B € 7,90



WATER GLASS GREY

Art. 0830200N.C06 € 15,50

**SET WINEGLASS
THANGO GREY**

Art. 0830184N.C06 € 25,50



Scodella ø 15 cm

Art. 0830043N.C9B € 9,50



✓ 30 cl

PACK 2X

✓ 60 cl

PACK 2X



Insalatiera ø 28 cm

Art. 0830030N.C9B € 15,90



TÊTE-Â-TÊTE COTTERY

Art. 0830143N.C9B

PCS. 8

€ 59,90

	2 x Ø 21 cm
	2 x Ø 25 cm
	2 x Ø 15 cm
	2 x 30 cl



MIDDAY COTTERY

Art. 0830148N.C9B

PCS. 12

€ 83,50

	4 x Ø 15 cm
	4 x Ø 20 cm
	4 x Ø 25 cm



LUNCH BOX COTTERY

Art. 0830155N.C9B

PCS. 16

€ 109,90

	4 x Ø 21 cm
	4 x Ø 20 cm
	4 x Ø 25 cm
	4 x 30 cl



ALL INCLUSIVE COTTERY

Art. 0830154N.C9B

PCS. 36

€ 168,50

	4 x Ø 21 cm
	4 x Ø 20 cm
	4 x Ø 25 cm
	4 x 30 cl
	4 x 20 cl
	16 pcs





KASSANDRA

PREMIUM CLASSIC

Piatto piano ø 25 cm

Art. 0830025N.C2K

€ 9,90



Tazzone 30 cl

Art. 0830035N.C2K

€ 7,90



Piatto fondo ø 21 cm

Art. 0830026N.C2K

€ 9,90



Scodella ø 15 cm

Art. 0830043N.C2K

€ 9,50



Piatto dessert ø 20 cm

Art. 0830027N.C2K

€ 8,90



Insalatiera ø 28 cm

Art. 0830030N.C2K

€ 15,90



SET WATERGLASS BROWNSATIN

Art. 0830183N.C02

€ 23,50

✓ 35 cl

PACK 2X



SET WINEGLASS BROWNSATIN

Art. 0830184N.C02

€ 26,50

✓ 60 cl

PACK 2X



TÊTE-Â-TÊTE KASSANDRA

Art. 0830143N.C2K

PCS. 8

€ 59,90

2 x Ø 21 cm

2 x Ø 25 cm

2 x Ø 15 cm

2 x 30 cl



MIDDAY KASSANDRA

Art. 0830148N.C2K

PCS. 12

€ 83,50

4 x Ø 15 cm

4 x Ø 20 cm

4 x Ø 25 cm



LUNCH BOX KASSANDRA

Art. 0830155N.C2K

PCS. 16

€ 109,90

4 x Ø 21 cm

4 x Ø 20 cm

4 x Ø 25 cm

4 x 30 cl



ALL INCLUSIVE KASSANDRA

Art. 0830154N.C2K

PCS. 36

€ 168,50

4 x Ø 21 cm

4 x Ø 20 cm

4 x Ø 25 cm

4 x 30 cl

4 x 20 cl

16 pcs



TIVOLI

PREMIUM CLASSIC

Piatto piano ø 25 cm

Art. 0830025N.C7X

€ 9,90



Tazzone 30 cl

Art. 0830035N.C7X

€ 7,90



Piatto fondo ø 21 cm

Art. 0830026N.C7X

€ 9,90



Scodella ø 15 cm

Art. 0830043N.C7X

€ 9,50



Piatto dessert ø 20 cm

Art. 0830027N.C7X

€ 8,90



Insalatiera ø 28 cm

Art. 0830030N.C7X

€ 15,90



SET WATERGLASS BLACKSATIN

Art. 0830183N.C1M

€ 23,50

✓ 35 cl

PACK 2X

SET WINEGLASS BLACKSATIN

Art. 0830184N.C1M

€ 26,50

✓ 60 cl

PACK 2X



TÊTE-Â-TÊTE TIVOLI

Art. 0830143N.C7X

PCS. 8

€ 59,90

	2 x Ø 21 cm
	2 x Ø 25 cm
	2 x Ø 15 cm
	2 x 30 cl



MIDDAY TIVOLI

Art. 0830148N.C7X

PCS. 12

€ 83,50

	4 x Ø 15 cm
	4 x Ø 20 cm
	4 x Ø 25 cm



LUNCH BOX TIVOLI

Art. 0830155N.C7X

PCS. 16

€ 109,90

	4 x Ø 21 cm
	4 x Ø 20 cm
	4 x Ø 25 cm
	4 x 30 cl



ALL INCLUSIVE TIVOLI

Art. 0830154N.C7X

PCS. 36

€ 168,50

	4 x Ø 21 cm
	4 x Ø 20 cm
	4 x Ø 25 cm
	4 x 30 cl
	4 x 20 cl
	16 pcs



GRANYTE

PREMIUM CLASSIC



MUG SET GRANYTE

Art. 0830051C.C1M

€ 25,90

PCS. 4



Set tazzoni in Resylin di alta qualità.

TÊTE-Â-TÊTE GRANYTE

Art. 0830143N.C1M

€ 59,90

PCS. 8

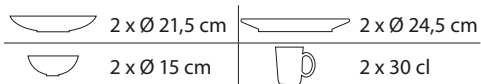

Piatto piano ø 24,5 cm

Art. 0830025N.C1M € 9,90



Piatto fondo ø 21,5 cm

Art. 0830026N.C1M € 9,90



Piatto dessert ø 19,5 cm

Art. 0830027N.C1M € 8,90



Tazzone 30 cl

Art. 0830051N.C1M € 7,50



MIDDAY GRANYTE

Art. 0830148N.C1M

€ 83,50

PCS. 12

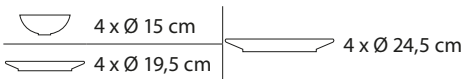

Scodella ø 15 cm

Art. 0830043N.C1M € 9,50



Insalatiera ø 23,5 cm

Art. 0830030N.C1M € 15,50



Portauovo

Art. 0830032N.C1M € 4,90



Burriera 13,5 x 9,5 x H6,5 cm

Art. 0830099N.C1M € 11,50



Tazzina espresso

Art. 0830063N.C3S € 7,90



Insalatiera ø 25 cm

Art. 0830044N.C1M € 45,90



LUNCH BOX GRANYTE

Art. 0830155N.C1M

€ 109,90

PCS. 16

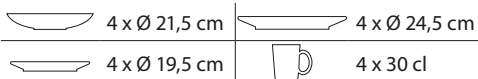

ALL INCLUSIVE GRANYTE

Art. 0830154N.C1M

PCS. 36

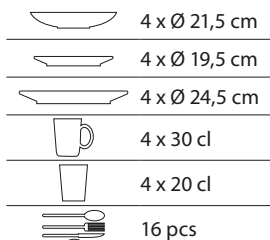

€ 168,50



SANDHYA

PREMIUM CLASSIC



Piatto piano ø 26 cm

Art. 0830025N.C2E € 9,90



Piatto fondo ø 23,5 cm

Art. 0830026N.C2E € 9,90



Piatto dessert ø 21 cm

Art. 0830027N.C2E € 8,90



Bicchiere 30 cl

Art. 0830185N.C2E € 5,90



Scodella ø 15 cm

Art. 0830043N.C2E € 9,50



Insalatiera ø 23,5 cm

Art. 0830030N.C2E € 15,90



Portauovo

Art. 0830032N.C2E € 4,90



Burriera

Art. 0830059N.C2E € 7,50



Tagliere 23,5x14,5 cm

Art. 0830021N.C2E € 8,50



Tazzina espresso 10 cl







Art. 0830055N.C06 € 7,90



ALL INCLUSIVE SANDHYA

Art. 0830154N.C2E

PCS. 36+1

	4 x Ø 23,5 cm
	4 x Ø 21 cm
	4 x Ø 26 cm
	4 x 30 cl
	4 x 20 cl
	16 pcs



€ 168,50

Tazzone 30 cl

Art. 0830051N

€ 7,50



C08

C34

C06





TÊTE-Â-TÊTE SANDHYA

Art. 0830143N.C2E

€ 59,90

PCS. 8



	2 x Ø 23,5 cm		2 x Ø 26 cm
	2 x Ø 15 cm		2 x 30 cl



MIDDAY SANDHYA

Art. 0830148N.C2E

€ 83,50

PCS. 12



	4 x Ø 15 cm		4 x Ø 26 cm
	4 x Ø 21 cm		





DINNER SERVICE SANDHYA

Art. 0830151N.C2E

€ 109,90

PCS. 16



	4 x Ø 23,5 cm		4 x Ø 26 cm
	4 x Ø 21 cm		4 x 30 cl

**Piatto piano ø 25 cm**

Art. 0830025N.C7B € 9,90

**Piatto fondo ø 21 cm**

Art. 0830026N.C7B € 9,90

**Piatto dessert ø 20 cm**

Art. 0830027N.C7B € 8,90

**Scodella ø 15 cm**

Art. 0830043N.C7B € 9,50

**Insalatiera ø 23,5 cm**

Art. 0830030N.C7B € 15,90

**Portauovo**

Art. 0830032N.C7B € 4,90

**Coperchio per scodelle ø 15 cm**

Art. 0830020N.C7B € 5,90

**Tazza con coperchio 30 cl**

Art. 0830023N.C7B € 9,50

**Bicchiere 30 cl**

Art. 0830185N.C7B € 5,90

**Bicchiere 40 cl**

Art. 0830187S.C7B € 6,90

**Burriera**

Art. 0830059N.C7B € 7,50

**Vassoio ø 30 cm**

Art. 0830080N.C7B € 19,50

**Tagliere 23,5x14,5 cm**

Art. 0830021N.C7B € 8,50

**Lattiera 30 cl**

Art. 0830058N.C7B € 8,50

**Tazzone 30 cl**

Art. 0830051N.C34 € 7,50

**MUG SET**

Art. 0830051C.C34

PCS. 4

€ 29,90



Set tazzoni in Resylin di alta qualità.

SET MULTIGLASS SPACE

Art. 0830185C.C7B

PCS. 3

€ 23,90



Bicchiere sovrapponibile. Materiale: SAN ad uso alimentare. 30 cl

FESTA SPACE

Art. 0830187N.C7B

PCS. 2

€ 14,50



Grande bicchiere impilabile in acrilico alimentare. 40 cl.

Contenitore ø 12x14,5 cm
Art. 0830040N.C34 € 8,90



Posate insalata
Art. 0830039N.C34 € 7,50



Cestino pane 24x24 cm
Art. 0830060N.C34 € 14,50



Tagliere/vassoio 36x24 cm
Art. 0830056N.C34 € 17,90



Tazza con piattino 25 cl
Art. 0830022N.C34 € 8,50



Tazzina espresso 10 cl
Art. 0830055N.C34 € 7,90



SET ESPRESSO SPECTRUM

Art. 0830055C.C34 € 15,90
PCS. 2



Portacenera
Art. 0830071N.C34 € 3,50



TÊTE-Â-TÊTE SPACE

Art. 0830143N.C7B
PCS. 8

€ 59,90

	2 x Ø 21 cm
	2 x Ø 25 cm
	2 x Ø 15 cm
	2 x 30 cl



MIDDAY SPACE

Art. 0830148N.C7B
PCS. 12

€ 83,50

	4 x Ø 15 cm
	4 x Ø 20 cm
	4 x Ø 25 cm



LUNCH BOX SPACE

Art. 0830155N.C7B
PCS. 16

€ 109,90

	4 x Ø 21 cm
	4 x Ø 20 cm
	4 x Ø 25 cm
	4 x 30 cl



ALL INCLUSIVE SPACE

Art. 0830154N.C7B
PCS. 36+1

€ 168,50

	4 x Ø 21 cm
	4 x Ø 20 cm
	4 x Ø 25 cm
	4 x 30 cl
	4 x 20 cl
	16 pcs



+1





SPECTRUM

PREMIUM CLASSIC



Piatto piano ø 25 cm

Art. 0830025N.C1P € 9,90



Piatto dessert ø 20 cm

Art. 0830027N.C1P € 8,90



Insalatiera ø 23,5 cm

Art. 0830030N.C1P € 15,90



APPETIZER

Art. 0830042N.C9N

€ 20,90

35,5 x 8,5 x H 5,5 cm



Eleganti ciotoline per aperitivo. Realizzate in melamina di alta qualità. Complete di vassoio.

Posate insalata

Art. 0830039N

€ 7,50

COLORS C30 C10 C34



Contenitore ø 12x14,5 cm

Art. 0830040N

€ 8,90

COLORS C30 C10 C34



MUG SET SPECTRUM

Art. 0830051C.C9N

€ 29,90

PCS. 4



Set tazzoni in Resylin di alta qualità.

Cestino pane 24x24 cm

Art. 0830060N

€ 14,50

COLORS C30 C34 C11



Tagliere/vassoio 36x24 cm

Art. 0830056N

€ 17,90

COLORS C30 C34 C11



SPICE BOX

Art. 0830010N.C9N

€ 6,90

8 x Ø 6 cm

56 g

4 x 50 ml



Pratico portaspesie in plastica di alta qualità. 4 comparti separati. 6 colori assortiti.

OLIAC

Art. 0830000N.C9N

€ 16,50

2 x 130 ml



Oliera e acetiera con sistema di chiusura a tenuta. Colori Spectrum assortiti.

GRATTÙ

Art. 0830017N

€ 11,50



Set grattugia composto da 4 grattugie a fori differenti per sminuzzare alimenti in modo diverso. Materiale: PP/acciaio inox.

Scodella ø 15 cm

Art. 0830043N

€ 9,50



C30



C10



C34



C11

Piatto fondo ø 21 cm

Art. 0830026N

€ 9,90



C30



C10



C34



C11

Tazzone 30 cl

Art. 0830051N

€ 7,50



C30



C10



C34



C11

Tazzina espresso 10 cl

Art. 0830055N

€ 7,90



C30



C10



C34



C11

Tazza con piattino 25 cl

Art. 0830022N

€ 8,50



C30



C10



C34



C11

MUG'N SPOON

Art. 0830061N.C9N

€ 9,50



Tazzone con cucchiaino in melamina colorata. Impilabile e salvaspazio.

MINI SPOON SET

Art. 0830129N.C9N

€ 7,90

PCS. 4



SPOON SET

Art. 0830128N.C9N

€ 9,90

PCS. 4



LUNCH BOX SPECTRUM

Art. 0830155N.C9N

€ 109,90

PCS. 16



	4 x Ø 21 cm		4 x Ø 25 cm
	4 x Ø 20 cm		4 x 30 cl

ALL INCLUSIVE SPECTRUM

Art. 0830154N.C9N

€ 168,50

PCS. 36



	4 x Ø 21 cm		4 x Ø 25 cm
	4 x Ø 20 cm		4 x 30 cl
	4 x 20 cl		16 pcs

SET ESPRESSO SPECTRUM

Art. 0830055C

€ 15,90

PCS. 2

COLORS





SPHERICA

PREMIUM CLASSIC



Piatto piano ø 24,5 cm

Art. 0830025N.C7T € 9,90



Piatto fondo ø 20 cm

Art. 0830026N.C7T € 9,90



Piatto dessert ø 20 cm

Art. 0830027N.C7T € 8,90



Scodella ø 16 cm

Art. 0830043N.C7T € 9,50



Tazzone 30 cl

Art. 0830035N.C7T € 7,90



tritan™
from eastman



SET WINEGLASS SPHERICA

Art. 0830225N.C71

€ 25,90

60 cl

PACK 2X

Portauovo

Art. 0830032N.C7T € 4,90



Insalatiera ø 25 cm

Art. 0830030N.C7T € 15,90



ALL INCLUSIVE SPHERICA

Art. 0830154N.C7T

€ 168,50

PCS. 36



4 x Ø 20 cm	4 x Ø 24,5 cm
4 x Ø 20 cm	4 x 30 cl
4 x 20 cl	16 pcs

TÊTE-Â-TÊTE SPHERICA

Art. 0830143N.C7T

€ 59,90

PCS. 8



2 x Ø 20 cm	2 x Ø 24,5 cm
2 x Ø 16 cm	2 x 30 cl

MIDDAY SPHERICA

Art. 0830148N.C7T

€ 83,90

PCS. 12



4 x Ø 16 cm	4 x Ø 24,5 cm
4 x Ø 20 cm	

SET SPHERICA

Art. 0830160N.C7T

€ 109,90

PCS. 16



4 x Ø 20 cm	4 x Ø 24,5 cm
4 x Ø 20 cm	4 x 30 cl

TÊTE-Â-TÊTE NAUTICAL

Art. 0830143N.C8S

€ 59,90

PCS. 8



	2 x Ø 23,5 cm		2 x Ø 26 cm
	2 x Ø 15 cm		2 x 30 cl

MIDDAY NAUTICAL

Art. 0830148N.C8S

€ 83,50

PCS. 12



	4 x Ø 15 cm		4 x Ø 26 cm
	4 x Ø 21 cm		

DINNER SERVICE NAUTICAL

Art. 0830151N.C8S

€ 109,90

PCS. 16



	4 x Ø 23,5 cm		4 x Ø 26 cm
	4 x Ø 21 cm		4 x 30 cl

ALL INCLUSIVE NAUTICAL

Art. 0830154N.C8S

€ 168,50

PCS. 36+1



	4 x Ø 23,5 cm		4 x Ø 26 cm
	4 x Ø 21 cm		4 x 30 cl
	4 x 20 cl		16 pcs

NAUTICAL**SEVEN SEAS****Piatto piano ø 26 cm**

Art. 0830025N.C8S

€ 9,90

**Piatto fondo ø 23,5 cm**

Art. 0830026N.C8S

€ 9,90

**Piatto dessert ø 21 cm**

Art. 0830027N.C8S

€ 8,90

**Bicchieri 30 cl**

Art. 0830185N.C8S

€ 5,90

**Portauovo**

Art. 0830032N.C8S

€ 4,90

**Tazzone 30 cl**

Art. 0830024N.C8S

€ 6,90

**Scodella ø 15 cm**

Art. 0830043N.C8S

€ 9,50

**Insalatiera ø 23,5 cm**

Art. 0830030N.C8S

€ 15,90

**Tagliere 23,5x14,5 cm**

Art. 0830021N.C8S

€ 8,50

**Lattiera 30 cl**

Art. 0830058N.C22

€ 8,50

**SET WINEGLASS THANGO BLUE**

Art. 0830184N.C22

€ 25,50

V 60 cl

PACK 2X

Burriera 13,5 x 9,5 x H6,5 cm

Art. 0830099N.C22

€ 11,50

**Tazzone 30 cl**

Art. 0830051N.C22

€ 7,50

**Tazzina espresso 10 cl**

Art. 0830055N.C22

€ 7,90

**SET ESPRESSO**

Art. 0830055C.C22

€ 15,90

PCS. 2





BLUE OCEAN

SEVEN SEAS



SET WINEGLASS THANGO BLUE

Art. 0830184N.C22 € 25,50

60 cl

PACK 2X



Contenitore ø 12x14,5 cm

Art. 0830040N.C8C € 8,90



Posate insalata

Art. 0830039N.C8C € 7,50



Portacenere

Art. 0830071N.C22 € 4,90



Cestino pane 24x24 cm

Art. 0830060N.C22 € 14,50



Tagliere/vassoio 36x24 cm

Art. 0830056N.C22 € 17,90



Appetizer 35,5x8,5xH5,5 cm

Art. 0830042N.C8C € 20,90



MUG SET

Art. 0830051C.C22

€ 29,90

PCS. 4



Set tazzoni in Resylin di alta qualità.

SET MULTIGLASS BLUE OCEAN

Art. 0830185C.C8C

€ 23,90

PCS. 3



Bicchiere sovrapponibile. Materiale: SAN ad uso alimentare. 30 cl

MUG SET BLUE OCEAN

Art. 0830024C.C8C

€ 27,50

PCS. 4



Set tazzoni in melamina di alta qualità.

FESTA BLUE OCEAN

Art. 0830187N.C8C

€ 14,50

PCS. 2



Grande bicchiere impilabile in acrilico alimentare. 40 cl.

ALL INCLUSIVE BLUE OCEAN

Art. 0830154N.C8C

€ 168,50

PCS. 36+1



+1

	4 x Ø 21 cm
	4 x Ø 20 cm
	4 x Ø 25 cm
	4 x 30 cl
	4 x 30 cl
	16 pcs

Piatto piano ø 25 cm

Art. 0830025N.C8C € 9,90



Piatto fondo ø 21 cm

Art. 0830026N.C8C € 9,90



Piatto dessert ø 20 cm

Art. 0830027N.C8C € 8,90



Tazzone 30 cl

Art. 0830051N.C22 € 7,50



Tazzone 30 cl

Art. 0830024N.C8C € 7,50



Lattiera 30 cl

Art. 0830058N.C8C € 8,50



Tazzina espresso 10 cl

Art. 0830055N.C8C € 7,90



Tazza con piattino 25 cl

Art. 0830022N.C8C € 8,50



Burriera

Art. 0830059N.C8C € 7,50



Scodella ø 15 cm

Art. 0830043N.C8C € 9,50



Insalatiera ø 23,5 cm

Art. 0830030N.C8C € 15,90



Portauovo

Art. 0830032N.C8C € 4,90



Coperchio per scodelle ø 15 cm

Art. 0830020N.C8C € 4,90



Tagliere 23,5x14,5 cm

Art. 0830021N.C8C € 8,50



Vassoio 29,5 x 40 cm

Art. 0830081N.C8C € 29,90



SET ESPRESSO BLUE OCEAN

Art. 0830055C.C8C € 15,90

PCS. 2



Bicchiere 30 cl

Art. 0830185N.C8C € 5,90



Bicchiere 40 cl

Art. 0830187S.C8C € 6,90



LUNCH BOX BLUE OCEAN

Art. 0830155N.C8C

PCS. 16

€ 109,90

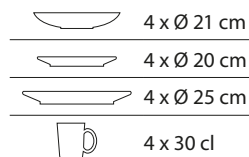

MIDDAY BLUE OCEAN

Art. 0830148N.C8C

PCS. 12

€ 83,50

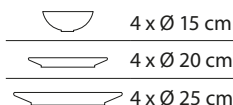

STACK BOX BLUE OCEAN

Art. 0830152N.C8C

PCS. 16

€ 122,50

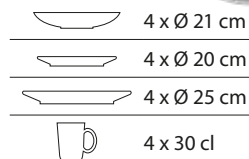

TÊTE-Â-TÊTE BLUE OCEAN

Art. 0830143N.C8C

PCS. 8

€ 59,90

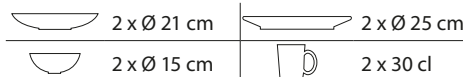



TÊTE-Â-TÊTE DEEP SEA

Art. 0830143N.C7R

€ 49,90

PCS. 8



	2 x Ø 21 cm		2 x Ø 25 cm
	2 x Ø 15 cm		2 x 30 cl

MIDDAY DEEP SEA

Art. 0830148N.C7R

€ 63,50

PCS. 12



	4 x Ø 15 cm		4 x Ø 25 cm
	4 x Ø 20 cm		

LUNCH BOX DEEP SEA

Art. 0830155N.C7R

€ 79,90

PCS. 16



	4 x Ø 21 cm		4 x Ø 25 cm
	4 x Ø 20 cm		4 x 30 cl

ALL INCLUSIVE DEEP SEA

Art. 0830154N.C7R

€ 136,50

PCS. 36



	4 x Ø 21 cm		4 x Ø 25 cm
	4 x Ø 20 cm		4 x 30 cl
	4 x 20 cl		16 pcs

DEEP SEA

ALLROUND



Piatto piano ø 25 cm

Art. 0830025N.C7R

€ 7,10



Piatto fondo ø 21 cm

Art. 0830026N.C7R

€ 6,90



Piatto dessert ø 20 cm

Art. 0830027N.C7R

€ 7,50



Tazzone 30 cl

Art. 0830051N.C06

€ 7,50



Tazzina espresso 10 cl

Art. 0830055N.C06

€ 7,90



Tazza con piattino 25 cl

Art. 0830022N.C06

€ 8,50



Scodella ø 15 cm

Art. 0830043N.C7R

€ 9,50



Insalatiera ø 23,5 cm

Art. 0830030N.C7R

€ 15,90



Bicchiere 30 cl

Art. 0830185N.C7R

€ 5,90



SAN

Posate insalata

Art. 0830039N.C06

€ 7,50



Portauovo

Art. 0830032N.C7R

€ 4,90



Burriera 13,5 x 9,5 x H6,5 cm

Art. 0830099N.C06

€ 11,50



Portacenera

Art. 0830071N.C06

€ 4,90



Tagliere/vassoio 36x24 cm

Art. 0830056N.C06

€ 17,90



Cestino pane 24x24 cm

Art. 0830060N.C06

€ 14,50



SET ESPRESSO

Art. 0830055C.C06

€ 15,90

PCS. 2



COSMIC

ALLROUND







TÊTE-Â-TÊTE COSMIC

Art. 0830143N.C8A

€ 49,90

PCS. 8



	2 x Ø 21 cm		2 x Ø 25 cm
	2 x Ø 15 cm		2 x 30 cl



MIDDAY COSMIC

Art. 0830148N.C8A

€ 63,50

PCS. 12



	4 x Ø 15 cm		4 x Ø 25 cm
	4 x Ø 20 cm		



SET COSMIC

Art. 0830160N.C8A

€ 69,50

PCS. 16

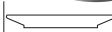

	4 x Ø 21 cm		4 x Ø 25 cm
	4 x Ø 20 cm		4 x 30 cl







ALL INCLUSIVE COSMIC

Art. 0830154N.C8A

€ 136,50

PCS. 36



	4 x Ø 21 cm		4 x Ø 25 cm
	4 x Ø 20 cm		4 x 30 cl
	4 x 20 cl		16 pcs

Piatto piano ø 25 cm

Art. 0830025N.C8A

€ 7,10



Piatto fondo ø 21 cm

Art. 0830026N.C8A

€ 6,90



Piatto dessert ø 20 cm

Art. 0830027N.C8A

€ 7,50



Tazzone 30 cl

Art. 0830051N.C8A

€ 7,50



Tazzina espresso 10 cl

Art. 0830055N.C8A

€ 7,90



Tazzone 30 cl

Art. 0830035N.C8A

€ 7,90



Scodella ø 15 cm

Art. 0830043N.C8A

€ 9,50



Insalatiera ø 23,5 cm

Art. 0830030N.C8A

€ 15,90



Bicchiere 30 cl

Art. 0830185N.C8A

€ 5,90



Posate insalata

Art. 0830039N.C8A

€ 7,50



Portauovo

Art. 0830032N.C8A

€ 4,90



Burriera

Art. 0830059N.C8A

€ 7,50



Lattiera 30 cl

Art. 0830058N.C8A

€ 8,50



Tagliere 23,5x14,5 cm

Art. 0830021N.C8A

€ 8,50



Vassoio ø 30 cm

Art. 0830080N.C8A

€ 19,50



SET ESPRESSO COSMIC

Art. 0830055C.C8A

€ 15,90

PCS. 2





SERENADE

ALLROUND



Piatto piano ø 25 cm

Art. 0830025N.C6A € 7,10



Piatto fondo ø 21 cm

Art. 0830026N.C6A € 6,90



Piatto dessert ø 20 cm

Art. 0830027N.C6A € 7,50



Tazzone 30 cl

Art. 0830035N.C6A € 7,90



Portauovo

Art. 0830032N.C6A € 4,90



Burriera

Art. 0830059N.C6A € 7,50



MELANGE

Art. 0830006N € 14,90

22,3 x ø 5 cm



Bicchiere 40 cl

Art. 0830187S.C6A € 6,90



POLYCARBONATE
HIGH QUALITY DRINKWARE



TÊTE-Â-TÊTE SERENADE

Art. 0830143N.C6A

€ 49,90

PCS. 8

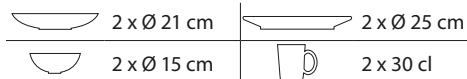

MIDDAY SERENADE

Art. 0830148N.C6A

€ 63,50

PCS. 12

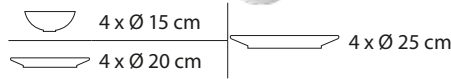

SET WINEGLASS THANGO BLACK

Art. 0830184N.C03

€ 25,50

60 cl

PACK 2X

Scodella ø 15 cm

Art. 0830043N.C03 € 9,50



Portacenera

Art. 0830071N.C03 € 4,90



SET SERENADE

Art. 0830160N.C6A

€ 69,50

PCS. 16

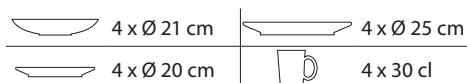

ALL INCLUSIVE SERENADE

Art. 0830154N.C6A

€ 136,50

PCS. 36

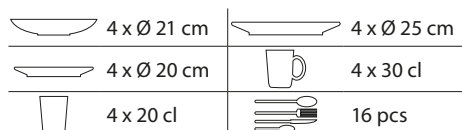

Tazzone 30 cl

Art. 0830051N.C03 € 7,50



Tazza con piattino 25 cl

Art. 0830022N.C03 € 8,50



Tazzina espresso 10 cl

Art. 0830055N.C03 € 7,90



SET ESPRESSO

Art. 0830055C.C03 € 15,90

PCS. 2



PRALIN

ALLROUND



Piatto piano ø 25 cm

Art. 0830025N.C6X € 7,10



Piatto dessert ø 20 cm

Art. 0830027N.C6X € 7,50



Portauovo

Art. 0830032N.C6X € 4,90



Appetizer 35,5x8,5xH5,5 cm

Art. 0830042N.C03 € 20,90



Bicchiere 30 cl

Art. 0830185N.C6X € 5,90



Piatto fondo ø 21 cm

Art. 0830026N.C6X € 6,90



Tazzone 30 cl

Art. 0830035N.C6X € 7,90



Scodella ø 15 cm

Art. 0830043N.C6X € 9,50



OLIAC

Art. 0830000N.C4N € 16,50

✓ 2x 130 ml



SET WINEGLASS THANGO BLACK & WHITE

Art. 0830184N.C4N

€ 25,50

✓ 60 cl

PACK 2X

Lattiera 30 cl

Art. 0830058N.C03 € 8,50



Contenitore ø 12x14,5 cm

Art. 0830040N.C03 € 8,90



Posate insalata

Art. 0830039N.C03 € 7,50



Burriera 13,5 x 9,5 x H6,5 cm

Art. 0830099N.C03 € 11,50



Tagliere/vassoio 36x24 cm

Art. 0830056N.C03 € 17,90



Cestino pane 24x24 cm

Art. 0830060N.C03 € 14,50



TÊTE-Â-TÊTE PRALIN

Art. 0830143N.C6X

€ 49,90

PCS. 8



	2 x Ø 21 cm		2 x Ø 25 cm
	2 x Ø 15 cm		2 x 30 cl

MIDDAY PRALIN

Art. 0830148N.C6X

€ 63,50

PCS. 12



	4 x Ø 15 cm		4 x Ø 25 cm
	4 x Ø 20 cm		

SET PRALIN

Art. 0830160N.C6X

€ 69,50

PCS. 16



	4 x Ø 21 cm		4 x Ø 25 cm
	4 x Ø 20 cm		4 x 30 cl

ALL INCLUSIVE PRALIN

Art. 0830154N.C6X

€ 136,50

PCS. 36



	4 x Ø 21 cm		4 x Ø 25 cm
	4 x Ø 20 cm		4 x 30 cl
	4 x 20 cl		16 pcs



KHADI

SQUARE



Piatto piano 26x26 cm

Art. 0830025N.C9T € 9,90



Piatto fondo 23x23 cm

Art. 0830026N.C9T € 8,90



Piatto dessert 20x20 cm

Art. 0830027N.C9T € 7,50



Bicchiere 30 cl

Art. 0830185N.C9T € 5,90



Scodella 15x15 cm

Art. 0830098N.C9T € 5,90



Insalatiera 25x25 cm

Art. 0830034N.C9T € 16,50



Tazzone 30 cl

Art. 0830051N.C1C € 7,50



Tazzina espresso 10 cl

Art. 0830055N.C1C € 7,90



Tazzina espresso 10 cl

Art. 0830055N.C06 € 7,90



Portauovo

Art. 0830032N.C9T € 4,90



Lattiera 30 cl

Art. 0830058N.C1C € 8,50



Tazza con piattino 25 cl

Art. 0830022N.C06 € 8,50



Burriera 13,5 x 9,5 x H6,5 cm

Art. 0830099N.C06 € 11,50



SET ESPRESSO

Art. 0830055C.C1C € 15,90

PCS. 2



Portacenere

Art. 0830071N.C06 € 4,90



MIDDAY KHADI'

Art. 0830148N.C9T

€ 88,50

PCS. 12

SET KHADI'

Art. 0830161N.C9T

€ 102,50

PCS. 16

ALL INCLUSIVE KHADI'

Art. 0830154N.C9T

€ 155,50

PCS. 36



4x 15 x 15 cm | 4x 20 x 20 cm | 4x 26 x 26 cm



4x 23 x 23 cm | 4x 20 x 20 cm | 4x 26 x 26 cm | 4 x 30 cl



4x 23 x 23 cm | 4x 20 x 20 cm | 4 x 20 cl | 4x 26 x 26 cm | 4 x 30 cl | 16 pcs

PANAREA

SQUARE

Piatto piano 25x25 cm

Art. 0830320N.C2X € 5,50



Piatto fondo 23x23 cm

Art. 0830310N.C2X € 5,90



Piatto dessert 20x20 cm

Art. 0830330N.C2X € 4,50



Scodella 15x15 cm

Art. 0830350N.C2X € 4,90



Tazzone 35 cl

Art. 0830140N.C2X € 4,90



SET PANAREA

Art. 0830161N.C2X

PCS. 16

€ 79,90

	4x 23 x 23 cm
	4x 20 x 20 cm
	4x 25 x 25 cm
	4 x 35 cl

ALL INCLUSIVE PANAREA

Art. 0830154N.C2X

PCS. 36

€ 136,50

	4x 23 x 23 cm
	4x 20 x 20 cm
	4x 25 x 25 cm
	4 x 35 cl
	4 x 20 cl
	16 pcs

Piatto piano 25x25 cm

Art. 0830320N.C5L € 5,50



Piatto fondo 23x23 cm

Art. 0830310N.C5L € 5,90



Piatto dessert 20x20 cm

Art. 0830330N.C5L € 4,50



Scodella 15x15 cm

Art. 0830350N.C5L € 4,90



Tazzone 35 cl

Art. 0830140N.C5L € 4,90



ENIGMA

SQUARE

SET ENIGMA

Art. 0830161N.C5L

PCS. 16

€ 79,90

	4x 23 x 23 cm
	4x 20 x 20 cm
	4x 25 x 25 cm
	4 x 35 cl

ALL INCLUSIVE ENIGMA

Art. 0830154N.C5L

PCS. 36

€ 136,50

	4x 23 x 23 cm
	4x 20 x 20 cm
	4x 25 x 25 cm
	4 x 35 cl
	4 x 20 cl
	16 pcs



SEQUOIA

FLASH



Piatto piano ø 26 cm

Art. 0830025N.C2A € 6,50



Scodella ø 15 cm

Art. 0830043N.C2A € 5,90



Piatto da portata 35x24 cm

Art. 0830053N.C2A € 9,90



Piatto fondo ø 21 cm

Art. 0830026N.C2A € 5,50



Insalatiera ø 24,5 cm

Art. 0830030N.C2A € 12,50



Portauovo

Art. 0830032N.C2A € 4,90



Piatto dessert ø 20 cm

Art. 0830027N.C2A € 4,50



MIDDAY SEQUOIA

Art. 0830148N.C2A

PCS. 12

€ 63,50



SET SEQUOIA

Art. 0830160N.C2A

PCS. 16

€ 77,50



Tazzone 30 cl

Art. 0830035N.C2A € 5,50

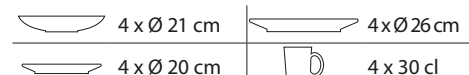
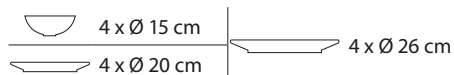

BREEZE

FLASH



Info p. 267



Piatto piano ø 26 cm
Art. 0830025N.C3B € 7,50



Scodella ø 16 cm
Art. 0830043N.C3B € 5,50



Piatto fondo ø 19 cm
Art. 0830026N.C3B € 7,50



Insalatiera ø 25 cm
Art. 0830030N.C3B € 13,90



Portauovo
Art. 0830032N.C3B € 4,90



Piatto dessert ø 23 cm
Art. 0830027N.C3B € 5,50



MIDDAY BREEZE
Art. 0830148N.C3B € 63,50
PCS. 12

SET BREEZE
Art. 0830160N.C3B € 77,50
PCS. 16

Tazzone 30 cl
Art. 0830077N.C3B € 5,50

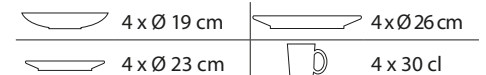
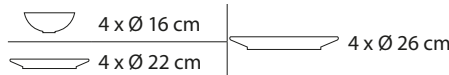



ASTRALYS

FLASH



BLUEBAY

FLASH





MIDDAY ASTRALYS

Art. 0830148N.C55

PCS. 12

€ 63,50

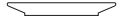

-  4 x Ø 15 cm
-  4 x Ø 20 cm
-  4 x Ø 25 cm



MIDDAY BLUEBAY

Art. 0830148N.C6T

PCS. 12

€ 42,90

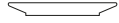

-  4 x Ø 13,5 cm
-  4 x Ø 21 cm
-  4 x Ø 25 cm





SET ASTRALYS

Art. 0830160N.C55

PCS. 16

€ 77,50



-  4 x Ø 22 cm
-  4 x Ø 20 cm
-  4 x Ø 25 cm
-  4 x 30 cl





SET BLUEBAY

Art. 0830160N.C6T

PCS. 16

€ 47,90



-  4 x Ø 21 cm
-  4 x Ø 20 cm
-  4 x Ø 25 cm
-  4 x 30 cl







ALL INCLUSIVE ASTRALYS

Art. 0830154N.C55

PCS. 36

€ 136,50



-  4 x Ø 22 cm
-  4 x Ø 20 cm
-  4 x Ø 25 cm
-  4 x 20 cl
-  4 x 30 cl
-  16 pcs







ALL INCLUSIVE BLUEBAY

Art. 0830154N.C6T

PCS. 36

€ 113,90







-  4 x Ø 21 cm
-  4 x Ø 20 cm
-  4 x Ø 25 cm
-  4 x 20 cl
-  4 x 30 cl
-  16 pcs

SET ESPRIT

Art. 0830160N.C5B

PCS. 16

€ 47,90

	4 x Ø 21 cm
	4 x Ø 20 cm
	4 x Ø 25 cm
	4 x 30 cl







**ALL INCLUSIVE ESPRIT**

Art. 0830154N.C5B

PCS. 36

€ 113,90







	4 x Ø 21 cm		4 x Ø 25 cm
	4 x Ø 20 cm		4 x 30 cl
	4 x 20 cl		16 pcs

**ESPRIT
FLASH****SET TULIP**

Art. 0830160N.C4E

PCS. 16

€ 47,90

	4 x Ø 21 cm
	4 x Ø 20 cm
	4 x Ø 25 cm
	4 x 30 cl







**ALL INCLUSIVE TULIP**

Art. 0830154N.C4E

PCS. 36

€ 113,90



	4 x Ø 21 cm		4 x Ø 25 cm
	4 x Ø 20 cm		4 x 30 cl
	4 x 20 cl		16 pcs

**TULIP
FLASH**



BBGRILL

LIVING



Piatto piano 31x27 cm
Art. 0830045N.C5R € 11,50



Appetizer 3x ø11cm / 40cm
Art. 0830041N.C5R € 20,90



Scodella 16x14 cm
Art. 0830047N.C5R € 9,90



Insalatiera 31x24,5 cm
Art. 0830046N.C5R € 19,90

SOUP BOWL

LIVING



Set zuppiera 1x 55 cl / 1x 24x18 cm
Art. 0830049N.C5T € 23,50



Set zuppiera 1x 55 cl / 1x 24x18 cm
Art. 0830049N.C3S € 23,50



Set zuppiera 1x 55 cl / 1x 24x18 cm
Art. 0830049N.C4P € 23,50



Set zuppiera 1x 55 cl / 1x 24x18 cm
Art. 0830049N.C4X € 23,50



100% Melamine

APPETIZER

Art. 0830042N.C06
35,5 x 8,5 x H5,5 cm

€ 20,90



CHEESE SET

Art. 0830134N

€ 38,90



40 x 20,5 cm



25 x 15,5 cm
Slate

9 x 9 x H5 cm
100% Melamine



GREENKICK

Art. 0830044N.C06
Ø 25 cm

€ 45,90



Art. 0830044N.C4P



Art. 0830044N.C1M



PASTA & SALAD

LIVING





PASTA & SALAD SET

Art. 0830132N

PCS. 5

€ 46,50

 1 x Ø 29,5 cm

 4 x Ø 20 cm

PIZZA

LIVING



SET PIZZA

Art. 0830131N

PCS. 2

€ 21,50

 Ø 37,5 cm

BREAD BOARD

Art. 0830056N.C06

€ 17,90

 36 x 24 cm

BREAD BASKET

Art. 0830060N.C06

€ 14,50

 24 x 24 cm

BUTTER BOX

Art. 0830099N.C06

€ 11,50

 13,5 x 9,5 x H6,5 cm



ICE CREAM COLLECTION

SET ICE CREAM CUP

Art. 0830037N.C9N

€ 27,50

Ø 12 cm

PCS. 4



Set di 4 ciotole per gelato in melamina di alta qualità. Con cucchiaini.

SET ICE CREAM BOWL

Art. 0830036N.C9N

€ 27,50

Ø 11 cm

PCS. 4



Set di 4 ciotole per gelato in melamina di alta qualità. Con cucchiaini.

ICE CREAM SCOOPER

Art. 0830038N.C9N

€ 4,90



Paletta per gelato in melamina di alta qualità.



kids
collection



1x 220 ml
1X | 1x 20 x 23 cm

Silicon Soft Touch



JUNGLE PARADE 6M+

Art. 0830072N

€ 19,90

PCS. 3



100%
silicone

AROUND THE WORLD 6M+

Art. 0830076N

€ 19,90

PCS. 3





100%
silicone

KIDS

COLLECTION

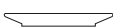

	1x Ø 16 cm		1x Ø 22 cm
	2 pcs		1x 20 cl

BUTTERFLY 3+

Art. 0830073N

PCS. 5



€ 21,50

FARM 3+

Art. 0830074N

PCS. 5



€ 21,50

TIME TO TRAVEL 3+

Art. 0830077N

PCS. 5



€ 21,50

MOLLY 3+

Art. 0830078N

PCS. 5



€ 21,50

JACK 3+

Art. 0830079N

PCS. 5



€ 21,50

LET'S GO ADVENTURE 3+

Art. 0830070N

PCS. 5



€ 21,50



EASTWOOD

EASTWOOD

Art. 0830115N

PCS. 12

€ 74,90

Classico set stoviglie da 12 pezzi. Realizzato in acciaio smaltato con anello di protezione in acciaio inox.

CARATTERISTICHE:

- Acciaio di alta qualità con rivestimento in smalto
- Superficie antiruggine
- Robuste, resistenti e leggere
- Perfette per le attività all'aria aperta
- Igieniche e facili da pulire

	4x 50 cl
	4 x Ø 18 cm
	4 x Ø 24 cm



1

2



Melamineware

BIWAK

Art. 0832043N

€ 19,50

100 g



Set posate outdoor in acciaio inox di ottima qualità. Il set comprende coltello, forchetta e cucchiaio collegati mediante un anello apribile.



GLUG

Art. 0830007N

€ 14,50

105 g

300 ml

Classico tazzone realizzato in acciaio inox.



LEGEND KARAMUG

Art. 0820068N

€ 12,50

Ø 7 x H8 cm

113 g

200 ml

Tazzone termoisolante a doppia parete realizzato in acciaio inox.



INOX

Stainless Steel

HUNGRY

Art. 0830110N.C30

€ 12,90



Ø 17,5/14 x 6 cm

HUNGRY XL

Art. 0830111N.C30

€ 18,50



Ø 22/18,5 x 6 cm

Ciotola per cani realizzata in resistente melamina con inserto in acciaio inox e pratico anello antiscivolo. Ideale per l'amico più fedele del camperista.

CUTRAY

Art. 0420010N

€ 9,90



 33,5 x 24,5 x H4,5 cm

Portaposate in materiale plastico.

MANTIS

Art. 0420008N

€ 15,90



 39,5 x 31,5 x H6 cm

 23,5 x 31,5 x H6 cm

 100% PP

Portaposate da cassetto. Regolabile, a 7 scomparti, con inserto superiore riposizionabile.

CHOPPER

Art. 0420002N

€ 14,90



 32 x 23 cm

Tagliere in bambù utilizzabile su entrambi i lati.

DELICIA

Art. 0832005N

€ 4,90



COLORS  

 30 x 45 cm

 Syntex



Tovaglietta decorativa, dà un tocco di colore alla tavola. Pratica, molto resistente e di facile pulizia.





DELICE

Art. 0832016N

€ 34,90 Set posate composto da 16 pezzi. Esecuzione molto solida con anima in metallo.

COLORS C06 C10 C03 C11 C02 C34 C8A C30



SAVOR

Art. 0832018N.C22

€ 28,50 Set posate in acciaio inox composto da 16 pezzi. Manico in materiale plastico con foro per appendere.



PARTY

Art. 0832015N

€ 38,90 Posate in acciaio inox anti-ruggine con manico anti-scivolo. Set da 16 pezzi.

COLORS C06 C30



PATIS

Art. 0832009N.C25



€ 29,50



Set posate composto da 16 pezzi.

AMyla

Art. 0832008N.C06



€ 34,90



Set posate dal design moderno, composto da 16 pezzi. Esecuzione molto solida con anima in metallo.

**SAPORA**

Art. 0832011N

COLORS C22 C48 C1C



€ 28,90



Set posate composto da 16 pezzi. Esecuzione molto solida con anima in metallo.

JOIA

Art. 0832017N



€ 39,90



Set posate composto da 16 pezzi in acciaio inossidabile.



CUVÉE

COLLECTION



SCRATCH RESISTANT
HIGH IMPACT RESISTANCE

POLYCARBONATE
HIGH QUALITY DRINKWARE

PERFECTLY TRANSPARENT
LIGHTWEIGHT

Il policarbonato è un materiale trasparente (polimero) che riunisce molte caratteristiche utili di metallo, vetro e materiali sintetici: altissima resistenza agli urti • anti-graffio • alta resistenza alla temperatura • ottime caratteristiche ottiche (trasparenza) • autoestinguente.

WATER GLASS

Art. 0830200N.C71

€ 15,50

WHITE WINEGLASS

Art. 0830171N.C71

€ 22,50

WINEGLASS

Art. 0830191N.C71

€ 26,50

30 cl

PACK 2X



30 cl

PACK 2X



45 cl

PACK 2X



tritan™
from eastman

R&W WINEGLASS

Art. 0830166N.C71

€ 23,90

RED WINEGLASS

Art. 0830184N.C71

€ 23,50

PROSECCO GLASS

Art. 0830205N.C71

€ 20,90

69 cl

PACK 2X



60 cl

PACK 2X



25 cl

PACK 2X



Freezer



WATER GLASS



WHITE WINEGLASS

tritan™
from eastman

WINEGLASS



R&W WINEGLASS

RED WINEGLASS



PROSECCO GLASS

Il materiale plastico Tritan è un'alternativa equivalente al polycarbonato ampiamente utilizzato. Tritan è stato sviluppato specificamente come alternativa senza BPA al polycarbonato, noto per contenere quantità minori di BPA. Perfettamente adatto per la produzione di bicchieri in plastica infrangibili che assomigliano esattamente a bicchieri di vetro, bicchieri di plastica, bicchieri da vino o eleganti calici.

CARATTERISTICHE SPECIALI DI TRITAN

- I prodotti Tritan sono trasparenti, durevoli e sicuri
- Tritan non contiene BPA, BPS o altri bisfenoli
- Tritan ha una resistenza alla rottura molto maggiore rispetto ad altre materie plastiche e vetro
- Tritan non si ammacca
- Tritan ha un look ed un feel simile al vetro
- Il Tritan non diventa nebuloso o torbido dopo il lavaggio
- Tritan può essere sagomato come desiderato (in produzione)
- Tritan è più leggero del vetro
- Tritan è sicuro per i bambini
- Tritan è in grado di resistere a temperature fino a 85°C



tritanTM
from eastman

WATER GLASS

Art. 0830216N.C71 € 20,50

V 30 cl

PACK 2X



WINEGLASS

Art. 0830218N.C71 € 24,90

V 45 cl

PACK 2X



WHITE WINEGLASS

Art. 0830219N.C71 € 26,50

V 42 cl

PACK 2X



R&W WINEGLASS

Art. 0830213N.C71 € 23,90

V 58 cl

PACK 2X



RED WINEGLASS

Art. 0830220N.C71 € 29,90

V 72 cl

PACK 2X



PROSECCO GLASS

Art. 0830217N.C71 € 24,90

V 25 cl

PACK 2X



Freezer



WATER GLASS

WINEGLASS

WHITE
WINEGLASS

R&W WINEGLASS

RED
WINEGLASS

PROSECCO GLASS



AMADÉ

COLLECTION



WATER GLASS



R&W WINEGLASS



WHITE WINEGLASS



WINEGLASS

SET WATERGLASS

Art. 0830221N.C71

€ 21,50

45 cl

PACK 2X



SET WINEGLASS

Art. 0830223N.C71

€ 24,90

60 cl

PACK 2X



tritan™
from eastman

SET R&W WINEGLASS

Art. 0830224N.C71

€ 24,50

58 cl

PACK 2X



SET WHITE WINEGLASS

Art. 0830226N.C71

€ 22,50

42 cl

PACK 2X



CORALUX

SET WINEGLASS

Art. 0830231N.C25

€ 18,50

40 cl

PACK 2X

SET WATERGLASS

Art. 0830230N.C25

€ 13,50

35 cl

PACK 2X



SET BOWLS

Art. 0830232N.C25

€ 15,90

80 cl

PACK 2X

SET WINEGLASS SPHERICA

Art. 0830225N.C71

€ 25,90

 60 cl

PACK 2X



tritan™

from eastman
**SET WATERGLASS BLACKSATIN**

Art. 0830183N.C1M

€ 23,50

 35 cl

PACK 2X

SET WINEGLASS BLACKSATIN

Art. 0830184N.C1M

€ 26,50

 60 cl

PACK 2X

**SET WATER GLASS GREY**

Art. 0830200N.C06

€ 15,50

 30 cl

PACK 2X

**SET WINEGLASS THANGO BLACK**

Art. 0830184N.C03

€ 25,50

 60 cl

PACK 2X

**SET WATERGLASS BROWNSATIN**

Art. 0830183N.C02

€ 23,50

 35 cl

PACK 2X

SET WINEGLASS BROWNSATIN

Art. 0830184N.C02

€ 26,50

 60 cl

PACK 2X

**SET WINEGLASS THANGO GREY**

Art. 0830184N.C06

€ 25,50

 60 cl

PACK 2X

**SET WINEGLASS THANGO BLACK & WHITE**

Art. 0830184N.C4N

€ 25,50

 60 cl

PACK 2X





BEER

COLLECTION

SCRATCH RESISTANT
HIGH IMPACT RESISTANCE
POLYCARBONATE
HIGH QUALITY DRINKWARE
PERFECTLY TRANSPARENT
LIGHTWEIGHT

tritan™
from eastman

tritan™
from eastman



PINT

TULIP

SPECIAL

PILSNER

MUNICH

CLASSIC

SET BEERGLASS PINT

Art. 0830210N.C71

€ 16,50



57 cl

PACK 2X

SET BEERGLASS TULIP

Art. 0830211N.C71

€ 24,50



46 cl

PACK 2X

tritan™
from eastman

SET BEERGLASS SPECIAL

Art. 0830173N.C71

€ 28,90



50 cl

PACK 2X

SET BEERGLASS PILSNER

Art. 0830209N.C71

€ 21,90



44 cl

PACK 2X

tritan™
from eastman

SET BEERGLASS MUNICH

Art. 0830196N.C71

€ 29,50



55 cl

PACK 2X

SET BEERGLASS CLASSIC

Art. 0830174N.C71

€ 32,50



60 cl

PACK 2X

PC-CARAFFE

Art. 0830193N

€ 14,50

V 520 ml

COLORS C34 C00**PC-CARAFFE**

Art. 0830172N

€ 22,90

V 1000 ml

COLORS C34 C00**VIAL**

Art. 0830203N.C71

€ 20,90

V 900 ml



COGNAC WHISKY GRAPS COLLECTION

**SET COGNAC**

Art. 0830202N.C71

€ 23,50

V 43 cl



PACK 2X

SET GRAPS

Art. 0830180N.C71

€ 11,50

V 30 ml



PACK 2X

SET KAPTIM

Art. 0830222N.C71

€ 12,50

V 25 cl



PACK 2X



BALOONS

Art. 0830212N.C9N € 21,90

✓ 35 cl

PACK 3X

ASSORTED



BALOONS

Art. 0830182N € 14,90

✓ 35 cl

PACK 2X

COLORS C30 C10 C34



OXIGEN

Art. 0830208N.C9N

✓ 30 cl

PACK 4X



€ 20,90



VINTAGE

Art. 0830195N

✓ 30 cl

PACK 4X

€ 23,90



COOL CUBES

Art. 0826005N

€ 5,90

PACK 10X



Cubetti ghiaccio riutilizzabili in materiale plastico. Perfetti per raffreddare tutti i tipi di bevande.





Il SAN (Styrol-Acrylnitril) è un materiale plastico rigido e trasparente ad uso alimentare, adatto al lavaggio in lavastoviglie e quindi perfetto all'utilizzo in cucina.

**TAHITI**

Art. 0830181C.C9N

€ 18,50

 20 cl

PACK 4X

OCTOGLASS COLOR

Art. 0830207N.C9N

€ 28,90

 28 cl

PACK 4X

**MULTIGLASS COLOR**

Art. 0830192N.C9N

€ 28,50

 30 cl

PACK 4X

ASSORTED

**MULTIGLASS COLOR**

Art. 0830188N

€ 14,50

 30 cl

PACK 2X

COLORS

WINEGLASS GLAMOUR

Art. 0830184C.C1P

€ 44,50

 60 cl

PACK 2X4X





WINEGLASS SAN 20

Art. 0830186N.C30

€ 6,50

✓ 20 cl



OCTOGLASS BLUE

Art. 08302075.C30

€ 5,90

✓ 28 cl



WINEGLASS EPOCH

Art. 0830206N.C71

€ 12,50

✓ 17 cl

PACK 2X



SET OCTOGLASS

Art. 0830178N.C71

€ 23,50

✓ 28 cl

PACK 3X



SET COCKTAIL HIGH

Art. 0830165N.C71

€ 18,50

✓ 40 cl

PACK 2X



Il policarbonato è un materiale trasparente (polimero) che riunisce molte caratteristiche utili di metallo, vetro e materiali sintetici: altissima resistenza agli urti • antigraffio • alta resistenza alla temperatura • ottime caratteristiche ottiche (trasparenza) • autoestinguente.

DIAMOND

Art. 0830204N

€ 26,50

✓ 30 cl

PACK 4X



ONDA & JAZZ WINEGLASS

Art. 0830184C.C9N

€ 39,90

 60 cl

PACK 4X

**ONDA**

Art. 0830214N

€ 22,90

 300 ml

PACK 4X

**JAZZ**

Art. 0830215N

€ 23,50

 305 ml

PACK 4X





POPOTE COLLECTION

PFOAfree

ALUMINIUM

NON-STICK
PTFE COATING



Ideati per impedire ai cibi di attaccarsi, naturalmente senza che sia necessaria l'aggiunta di condimenti grassi e quindi per una cottura più sana! Garantito senza PFOA.

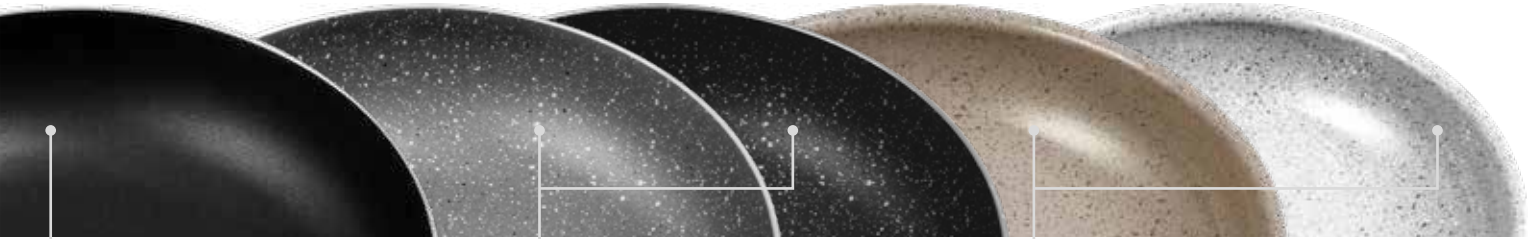

Classic Black

Rivestimento antiaderente a lunga durata. Igienico, affidabile, resistente agli shock termici, alla corrosione e facile da lavare.

Stone Rock

Speciale rivestimento effetto pietra rinforzato con minerali duri, ultrasensibile a graffi ed abrasioni.

Ceramic

Innovativo rivestimento interno in ceramica antiaderente. Ottima resistenza alle alte temperature ed agli sbalzi termici, non sfoglia, lavabile in lavastoviglie.

ALLUMINIO UN EFFICIENTE CONDUTTORE DI CALORE:

- è leggero • distribuisce il calore velocemente
 - fa risparmiare energia • regola meglio la temperatura.
- Rivestimento antiaderente.

COTTURA E PULIZIA PIÙ FACILI:

- si riduce l'utilizzo di grassi durante la cottura • evita che il cibo si bruci
- comodo da pulire.



HANDLES

PUSH SYSTEM CLAMP SYSTEM



VACUBLOCK SYSTEM

FUSION MAGNETIC, CAREZZA & PIRATE

Il nuovo sistema Vacublock protegge le vostre pentole e padelle durante il viaggio e celebra la straordinaria creatività del nostro team di sviluppo nella creazione di soluzioni funzionali per veicoli ricreazionali e barche.

- Facile e intuitivo da usare
- Blocca pentole e padelle mentre il veicolo è in movimento
- Elimina le possibilità di graffi della superficie antiaderente
- Elimina i rumori fastidiosi durante la guida



PATENTED



COVERY TRIO Ø 20 / 18 / 16 CM

Art. 0806107N € 18,50

220 g



COVERY TRIO Ø 22 / 20 / 18 CM

Art. 0806108N € 20,50

300 g

Coperchio universale in vetro con bordo graduato in silicone adatto per pentole e padelle di diversi diametri.

CARATTERISTICHE:

- Lavabile in lavastoviglie
- Foro per la compensazione della pressione
- Maniglia pieghevole salvaspazio
- Compatibile con il sistema VacuBlock

COVERY TRIO Ø 24 / 22 / 20 CM

Art. 0806109N € 21,50

380 g

COVERY Ø 24

Art. 0806103N € 19,90

400 g



COVERY Ø 22

Art. 0806102N € 18,50

340 g



COVERY Ø 20

Art. 0806101N € 16,90

260 g

Coperchio in vetro con bordo di protezione antirumore in silicone dotato di apertura colapasta e fessura per fissaggio della pinza prendi pentole.

CARATTERISTICHE:

- Bordo in silicone
- Lavabile in lavastoviglie
- Valvola di sfiato
- Maniglia pieghevole salvaspazio





PIRATE

STONE ROCK

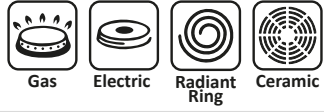

multiple
layer
coating



PIRATE 6+1 Ø 18

Art. 0806092N

€ 76,90

2,1 kg

Ø 18 cm	Ø 16 cm	Ø 18 cm	Ø 18 cm	Ø 16 cm	1X	1x	
3,3 l	1,6 l	1,3 l					



PIRATE 7+1 Ø 20

Art. 0806093N

€ 79,90

2,65 kg

Ø 20 cm	Ø 20 cm	Ø 16 cm	Ø 20 cm	Ø 18 cm	Ø 18 cm	1X	1x
4 l		1,6 l	1,5 l	1 l			



PIRATE 7+1 Ø 22

Art. 0806094N

€ 118,90

3,18 kg

Ø 22 cm	Ø 22 cm	Ø 22 cm	Ø 18 cm	Ø 22 cm	Ø 18 cm	1X	1x
5,3 l		1,8 l	2 l				



PIRATE 9+1 Ø 24

Art. 0806095N

€ 132,90

3,9 kg

Ø 24 cm	Ø 22 cm	Ø 20 cm	Ø 16 cm	Ø 24 cm	Ø 20 cm	Ø 24 cm	Ø 20 cm	1X	1x
6 l		2,5 l	1,5 l	2,2 l	1,5 l				



PIRATE MEPO BOX 16+9

Art. 0806086N

€ 178,50

8 kg

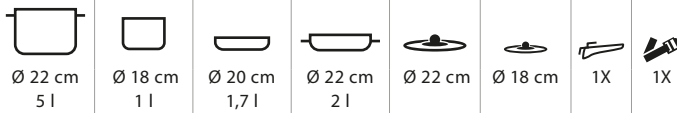

31 x 54 x H27,5 cm

Melamineware

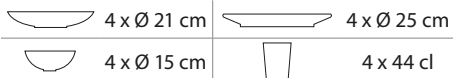

PIRATE PAN 3

Art. 0806089N

1,20 kg



€ 56,50



PIRATE POT 5

Art. 0806088N

1,90 kg

€ 71,50



PIRATE PAN 24

Art. 0806098N

0,55 kg

Ø 24 cm

€ 29,50



PIRATE PAN 26

Art. 0806097N

0,62 kg

Ø 26 cm

€ 30,90



PIRATE WOK

Art. 0806096N

0,75 kg

Ø 28 cm

€ 32,50



PIRATE SQUARE GRILL

Art. 0806099N

0,94 kg

28 x 28 cm

€ 34,90





PIRATE NG 7+1 Ø 20

Art. 0806083N

3,40 kg

€ 118,90



Ø 20 cm	Ø 20 cm	Ø 18 cm	Ø 16 cm	Ø 20 cm	Ø 20 / 18 / 16 cm	1x	1x
4 l	1,5 l	1,3 l	1,6 l				

PIRATE NG 7+1 Ø 22

Art. 0806084N

3,70 kg

€ 135,90



Ø 22 cm	Ø 22 cm	Ø 20 cm	Ø 18 cm	Ø 22 cm	Ø 22 / 20 / 18 cm	1x	1x
5,3 l	2 l	1,7 l	1 l				

PIRATE NG 7+1 Ø 24

Art. 0806085N

4,32 kg

€ 143,50



Ø 24 cm	Ø 24 cm	Ø 22 cm	Ø 20 cm	Ø 24 cm	Ø 24 / 22 / 20 cm	1x	1x
6 l	2,2 l	1,8 l	3 l				

PIRATE NG

STONE ROCK



VACUBLOCK System



H 20 cm



BRUNER



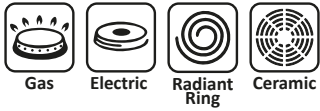
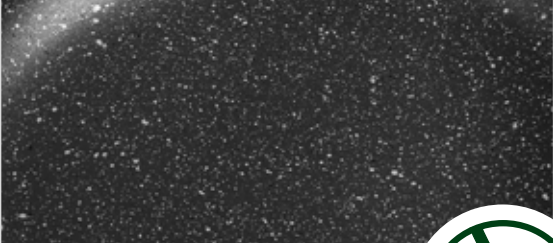

multiple layer coating

PIRATE SPACEMASTER Ø 20 MINI

Art. 0806087N

€ 85,50



Ø 20 cm H 9 cm	Ø 18 cm H 8 cm	Ø 20 cm H 5 cm	Ø 20 cm	1X



SPACEMASTER



H 15 cm



PIRATE SPACEMASTER Ø 22

Art. 0806064N

€ 98,50



Ø 22 cm H 10 cm	Ø 18 cm H 9 cm	Ø 22 cm H 5 cm	Ø 22 cm	1X



PIRATE SPACEMASTER Ø 24

Art. 0806063N

€ 106,50



Ø 24 cm H 10 cm	Ø 20 cm H 9 cm	Ø 24 cm H 5 cm	Ø 24 cm	2X



PIRATE SPACEMASTER Ø 26

Art. 0806061N

€ 117,50



Ø 26 cm H 5 cm	Ø 22 cm H 10 cm	Ø 18 cm H 9 cm	Ø 22 cm	2X

FUSION MAGNETIC CERAMIC

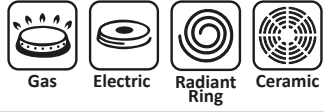

multiple
layer
coating



VACUBLOCK
System

PATENTED

FUSION 7+1 Ø 22

Art. 0806050N

€ 139,90



NEW
2023



Ø 22 cm 4,9 l	Ø 22 cm 1,5 l	Ø 20 cm 1,2 l	Ø 18 cm 1,7 l	Ø 22 cm	Ø 22 / 20 / 18 cm	1x



MAGNETOGRIP SYSTEM

Maniglia con sistema di connessione di nuova concezione che, attraverso l'uso di impugnature pieghevoli con elementi magnetici integrati, consente di ridurre notevolmente le dimensioni dell'imballaggio dei set di pentole e rende inoltre superfluo l'uso di una cinghia di fissaggio per stabilizzare la pentola e la padella durante il trasporto.

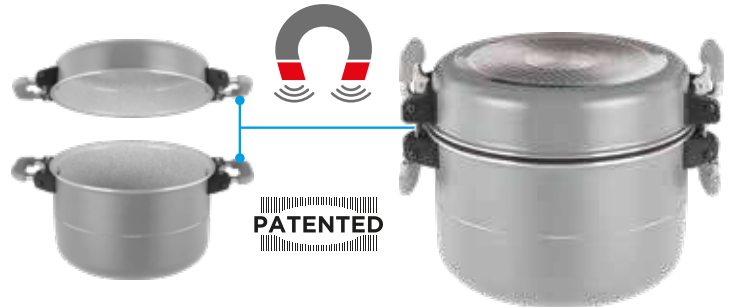

CAREZZA

CERAMIC



PFOAfree



100%
RECYCLED
ALUMINIUM

CAREZZA 7+1 Ø 22

Art. 0804082N

€ 113,90



NEW
2023



VACUBLOCK
System

PATENTED



Ø 22 cm H 14,5 cm	Ø 22 cm H 5 cm	Ø 20 cm H 5 cm	Ø 18 cm H 8 cm	Ø 22 cm	Ø 22 / 20 / 18 cm	1x

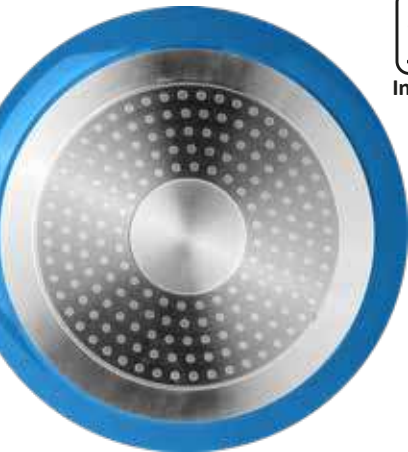

CAREZZA SPACEMASTER Ø 22 VACUBLOCK

Art. 0804081N

€ 107,50

NEW
2023



Ø 22 cm H 14,5 cm	Ø 18 cm H 8 cm	Ø 22 cm H 5 cm	Ø 22 / 20 / 18 cm	2X



CAREZZA PAN 24

Art. 0804084N

€ 27,50

Ø 24 cm

CAREZZA PAN 26

Art. 0804085N

€ 29,90

Ø 26 cm

NEW
2023



CAREZZA SPACEMASTER Ø 20 VACUBLOCK

Art. 0804080N

€ 89,90

NEW
2023



Ø 20 cm H 13 cm	Ø 16 cm H 8 cm	Ø 20 cm H 5 cm	Ø 20 / 18 / 16 cm	1X



100%
RECYCLED
ALUMINIUM

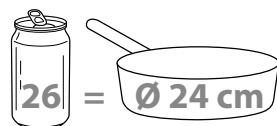

GOURMET ROCK NG

STONE ROCK

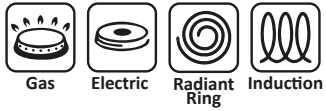

GOURMET ROCK NG 8+1 Ø 20

Art. 0806080N

€ 127,50

3,45 kg



Ø 20 cm	Ø 18 cm	Ø 16 cm	Ø 18 cm	Ø 20 cm	Ø 20 cm	Ø 18 cm	1x	1x
4 l	1,6 l	1 l	1,3 l	1,5 l				

GOURMET ROCK NG 9+1 Ø 22

Art. 0806081N

€ 149,90

4,10 kg



Ø 22 cm	Ø 22 cm	Ø 18 cm	Ø 16 cm	Ø 22 cm	Ø 18 cm	Ø 22 cm	Ø 18 cm	1x	1x
5,3 l		2,5 l	1 l	1,8 l	1,5 l				

GOURMET ROCK NG 9+1 Ø 24

Art. 0806082N

€ 138,90

4,20 kg



Ø 24 cm	Ø 22 cm	Ø 20 cm	Ø 16 cm	Ø 24 cm	Ø 18 cm	Ø 24 cm	Ø 20 cm	1x	1x
6 l		3 l	1,5 l	2,2 l	1,3 l				



GOURMET ROCK GRILL

Art. 0806071N

€ 39,50

1,15 kg
 28 x 28 cm



GOURMET ROCK SQUARE PAN 28

Art. 0806073N

€ 30,50

0,80 kg
 28 x 28 cm

GOURMET ROCK SQUARE PAN 26

Art. 0806072N

€ 28,90

0,75 kg
 26 x 26 cm



CHOCOLATE

CERAMIC



multiple layer coating

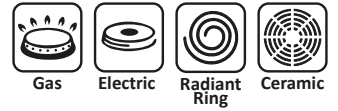

CHOCOLATE 7+1 Ø 20

Art. 0804041N

€ 97,50

2,75 kg



Ø 20 cm 4 l	Ø 16 cm 1,6 l	Ø 14 cm 1 l	Ø 20 cm 1,5 l	Ø 20 cm	Ø 16 cm	1x	1x

CHOCOLATE 9+1 Ø 22

Art. 0804042N

€ 149,90

3,70 kg



Ø 22 cm 5,3 l	Ø 22 cm	Ø 18 cm 2 l	Ø 14 cm 1 l	Ø 22 cm 1,8 l	Ø 20 cm 1,5 l	Ø 22 cm	Ø 18 cm	1x	1x

COSMIC

CERAMIC



multiple layer coating

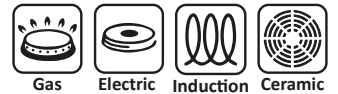

COSMIC 8+2 Ø 22

Art. 0804013N

€ 132,50

4,20 kg



Melamineware

Ø 22 cm 5,3 l	Ø 18 cm 3 l	Ø 22 cm 1,5 l	Ø 22 cm	Ø 18 cm	1x	1x



31 x 54 x H27,5 cm



SKIPPER

CLASSIC BLACK

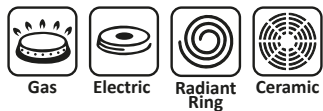

SKIPPER 7+1 Ø 18

Art. 0806006N

€ 86,50

2,5 kg



Ø 18 cm	Ø 16 cm	Ø 14 cm	Ø 18 cm	Ø 18 cm	Ø 16 cm	1 x	1 x
3,3 l	1,6 l	1 l	1 l				

SKIPPER 8+1 Ø 20

Art. 0806007N

€ 109,90

3,08 kg



Ø 20 cm	Ø 18 cm	Ø 14 cm	Ø 18 cm	Ø 20 cm	Ø 20 cm	Ø 18 cm	1 x	1 x
4 l	1,6 l	1 l	1,3 l	1,5 l				

SKIPPER 4+1 Ø 22

Art. 0806008N

€ 84,50

1,65 kg



Ø 22 cm	Ø 22 cm	Ø 22 cm	Ø 22 cm	1 x
5 l		2 l		

SKIPPER 9+1 Ø 22

Art. 0806009N

€ 134,90

3,82 kg



Ø 22 cm	Ø 22 cm	Ø 22 cm	Ø 18 cm	Ø 16 cm	Ø 20 cm	Ø 22 cm	Ø 18 cm	1 x	1 x
5 l		1,8 l	2 l	1,5 l	1,5 l				

SKIPPER 9+1 Ø 24

Art. 0806011N

€ 132,50

3,86 kg



Ø 24 cm	Ø 24 cm	Ø 22 cm	Ø 20 cm	Ø 16 cm	Ø 22 cm	Ø 24 cm	Ø 20 cm	1 x	1 x
6 l	2,2 l		3 l	1,5 l	1,5 l				

SKIPPER PAN

Pentola alluminio con fondo antiaderente. Con manico staccabile.



SOFT TOUCH



SKIPPER PAN Ø 20

Art. 0806040N

€ 16,50

320 g



ø 20 cm - 1 l

SKIPPER PAN Ø 22

Art. 0806041N

€ 22,50

380 g



ø 22 cm - 1,8 l

SKIPPER PAN Ø 24

Art. 0806044N

€ 21,90

420 g



ø 24 cm - 2 l

SKIPPER PAN Ø 26

Art. 0806042N

€ 22,90

450 g



ø 26 cm - 2,1 l

SKIPPER 4

Art. 0806037N

€ 33,50

750 gr



ø 20 cm - 1 l



ø 26 cm - 2,1 l



Set 4 pezzi di padelle in alluminio con fondo antiaderente e manici staccabili.

SKIPPER 6

Art. 0806038N

€ 49,90

1 kg



ø 16 cm - 1,6 l

ø 20 cm - 2,6 l

ø 16 cm

ø 20 cm

Set 6 pezzi di casseruole e coperchi in acciaio con fondo antiaderente e manici staccabili.

WOK

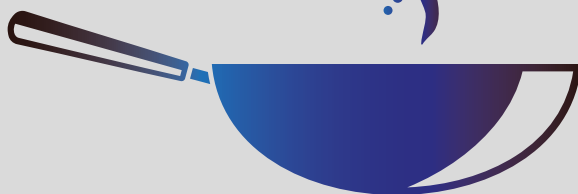

SKIPPER WOK

Art. 0806039N

€ 28,90

520 g

ø 28 cm



Padella Wok di alluminio con fondo antiaderente. Con manico staccabile.

JUNIPER NG

CLASSIC BLACK



Gas



Electric



Radiant Ring



Ceramic



NON-STICK SURFACE



alu



COMPACT STORAGE

PFOA free



SILICONE SOFT TOUCH



CLAMP SYSTEM



JUNIPER NG 7+1 Ø 20

Art. 0806075N.C34

€ 105,90



3 kg

Ø 20 cm	Ø 16 cm	Ø 14 cm	Ø 20 cm	Ø 20 cm	Ø 16 cm	1X	1X
4 l	1,6 l	1 l	1,5 l				



JUNIPER NG 8+1 Ø 22

Art. 0806060N.C34

€ 132,50



3,5 kg

Ø 22 cm	Ø 20 cm	Ø 14 cm	Ø 22 cm	Ø 22 cm	Ø 22 cm	Ø 20 cm	1X	1X
5,3 l	2,5 l	1 l	1,8 l					



JUNIPER NG 8+1 Ø 24

Art. 0806067N.C34

€ 126,90



3,94 kg

Ø 24 cm	Ø 20 cm	Ø 16 cm	Ø 24 cm	Ø 22 cm	Ø 24 cm	Ø 20 cm	1X	1X
6 l	3 l	1,5 l	2,2 l					





JUNIPER PAN

Art. 0806065N.C34

€ 27,50

 700 gr



Padella in alluminio con rivestimento antiaderente di ottima qualità. Dotata di praticissimo manico pieghevole salvaspazio brevettato.

COOKING SET

Art. 0832021N

€ 23,50



Set posate cucina composto da 6 pezzi. Realizzato in nylon alimentare.

POTGUARD

Art. 0806079N

€ 5,90



 Ø 20 / 22 / 24 cm

Protezione per pentole e padelle realizzata in feltro di poliestere. Ideale per prevenire graffi e altri danni causati da impilaggio, stoccaggio o rimozione. Fornita in set da 3 pezzi (20-22-24 cm).





ACADEMY NG

INOX



INOX Stainless Steel

Acciaio inox: Durevole e resistente agli urti. Resiste a graffi e ammaccature, rimanendo bello anche dopo anni di utilizzo. Ottimo conduttore termico: distribuisce il calore uniformemente. Igienico, facile da pulire e mantenere brillante.

BITER

Art. 0832027C

€ 23,90

110 g



Praticissima pinza prendi pentola con meccanismo di sicurezza contro l'apertura accidentale. Applicazione fissa a pentole e padelle. Esecuzione stabile e robusta.

TAKER

Art. 0832000C

€ 11,90

70 g



Pinza prendi pentole universale in materiale termoplastico per pentole e padelle.

ACADEMY PAN Ø 22

Art. 0804034N

€ 57,50



Ø 22 cm



ACADEMY DOUBLE PAN Ø 22/20

Art. 0804036N

€ 79,90



Ø 22 cm

Ø 20 cm

Ø 22 / 20 / 18 cm

1x



ACADEMY NG

INOX



PFOAfree

multiple layer coating



PFLUON



ACADEMY NG 5+1 Ø 20

Art. 0804031N

€ 114,90



Ø 20 cm 3,4l	Ø 20 cm	Ø 16 cm 1,4l	Ø 20 / 18 / 16 cm	1x	1x



induction sandwich bottom



ACADEMY NG 7+1 Ø 22

Art. 0804032N

€ 161,50



Ø 22 cm 4,5l	Ø 22 cm	Ø 18 cm	Ø 16 cm 1,4l	Ø 22 cm	Ø 22 / 20 / 18 cm	1x

Functional Cooking Lids



VACUBLOCK System

PATENTED



ACADEMY HIGH NG 7+1 Ø 22

Art. 0804033N

€ 149,90



Ø 22 cm 5,2l	Ø 22 cm	Ø 20 cm	Ø 18 cm 2,2l	Ø 22 cm	Ø 22 / 20 / 18 cm	1x

ACADEMY MINI

Art. 0804030N

€ 112,50



Ø 20 cm 2,8l	Ø 16 cm 1,4l	Ø 20 cm	Ø 20 cm	1x



VOLCANO

INOX



Gas



Electric



Halogen



Freezer

Inox
Stainless Steel

FOLD-AWAY



VOLCANO FOLD-AWAY Ø 24

Art. 0804026N

€ 54,50

Ø 24 x 4,5/14,5 cm

VOLCANO FOLD-AWAY Ø 20

Art. 0804027N

€ 43,90

Ø 20 x 3,5/8,5 cm



Pentole collapsabili per fornelli (gas ed elettrici).

CARATTERISTICHE:

- Pentole realizzate in silicone di alta qualità ed acciaio inox
- Coperchio in vetro con bordo antiscivolo
- Maniglie in metallo con rivestimento in silicone

VOLCANO PAN FOLD-AWAY

Art. 0804024N

€ 49,50

Ø 24 cm



FOLD-AWAY



VOLCANO PASTA AL VOLO

Art. 0804029N

€ 119,50

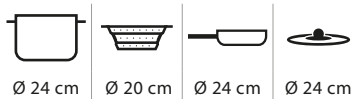

9 cm

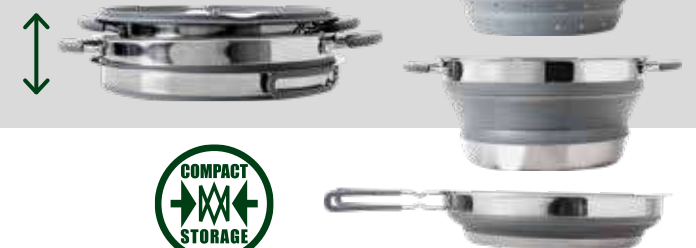

OMNIBOX

INOX



OMNIBOX 18+2 Ø 22

Art. 0804028N

€ 133,50

4,25 kg

INOX
Stainless Steel

Set cucina 18+2 con tutto il necessario per equipaggiare la cucina mobile.

SONO COMPRESI I SEGUENTI PEZZI:

- Pentola in acciaio inox con manici silicone Ø 22 cm - 3,5 litri • Coperchio Ø 22 cm in vetro con pomolo in silicone • Casseruola in acciaio inox Ø 17 cm - 1,3 litri con manico in silicone • Coperchio Ø 17 cm in vetro con pomolo in silicone • Contenitore in plastica Ø 16 cm con coperchio • Contenitore in plastica Ø 13 cm con coperchio • Contenitore in plastica Ø 11 cm con coperchio • Padella in acciaio inox Ø 23 cm - 1,5 litri con manico in silicone • Cucchiaino • Paletta • Mestolo • Cucchiaino forato • Pelapatate • Grattugia • Forbice • Coltello • Spazzolino lava piatti • Panno per pulire/asciugare • Borsa per stivaggio • Borsa per il trasporto



FOLD-AWAY COLANDER

Art. 0832210N

€ 13,50

RIDER

Art. 0830413N

€ 4,90



Ø 22 x 3,5/11 cm

220 g

COLORS

C11 C06

FOLD-AWAY

1,5 x 1,5 x 4,8 cm

PCS. 2

COLORS

C30 C34



Scolapasta colassabile. Prodotto in PP-TPR facile da pulire, resistente al calore e pieghevole.

Portamestolo in silicone.



DAYO

Art. 0802017N



Induction



V 1,8l

Ø 18 x H14,5 / 21 cm

420 g



Elegante bollitore realizzato in acciaio inox.

€ 31,90

DAYO BLACK NG

Art. 0802018N



Induction



V 1,8l

Ø 18 x H14,5 / 21 cm

420 g



Bollitore per l'acqua di costruzione identica al modello Dayo, ma dotato di fondo all'induzione e di manici in gomma antiscivolo. Design elegante.

€ 36,90

STEAMER TRAVEL

Art. 0802014N



Induction



V 2,5l

Ø 19 x H20 cm

810 g



Bollitore con fischio in acciaio inox munito di manico isolante ripiegabile e fondo sandwich.

€ 35,50

KETTY

Art. 0802012N



V 1l

Ø 15 x H14 cm

150 g



Bollitore acqua in resistente alluminio. Dotato di manico removibile in plastica.

€ 21,90



AMIGO 2

Art. 0830018N

€ 13,50

1-2 Cups / 7,5 cm

AMIGO



AMIGO 4

Art. 0830019N

€ 14,50

2-4 Cups / 9 cm



Filtro per caffè in acciaio inox estremamente leggero, pieghevole e facile da montare grazie ai suoi morsetti laterali metallici flessibili.

OUTDOOR LIFESTYLE



MC MOKA 3

Art. 0804078N

Ø 10 x 14,5 x H15 cm

316 g



MC MOKA 6

Art. 0804079N

Ø 12 x 17 x H20 cm

476 g

INOX
Stainless Steel



La caffettiera a induzione McMoka nasce dalla continua ricerca di nuove soluzioni, adatte ai cambiamenti e alla evoluzione dei gusti e delle abitudini dell'universo outdoor. Realizzata interamente in alluminio con fondo in acciaio, rappresenta la storica moka a cui non sappiamo rinunciare, ma con il vantaggio di una base molto ampia e di poter essere utilizzata su qualunque piano di cottura. Disponibile in 2 versioni, da 3 e da 6 persone.

LEGEND COFFEE NG

Art. 0820033N

€ 42,50

1 l

Ø 10 x H22 cm

490 g

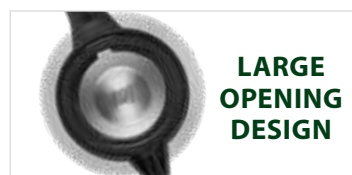

Thermos per caffè in acciaio inox a doppia parete.



PACKPOT ULTRALITE 18

Art. 0802024N

€ 46,50

PACKPOT ULTRALITE 20

Art. 0802026N

€ 66,90



672 g



Anodised



ultralight

PFOA free



Set popote Outdoor in alluminio anodizzato per 3/4 persone.

MANICI PIEGHEVOLI RIVESTITI IN SILICONE TERMOISOLANTE. IL SET È COMPOSTO DA:

- 1 pentolino con coperchio Ø 16,6 x 8,9 cm
- 1 padella Ø 16,7 x 4,4 cm
- 1 bollitore Ø 14,6 x 8,3 cm (1,1l)
- 1 mestolo in bambù
- sacchetto custodia



870 g



Anodised



ultralight

PFOA free



Set popote Outdoor in alluminio anodizzato per 4/5 persone.

MANICI PIEGHEVOLI RIVESTITI IN SILICONE TERMOISOLANTE. IL SET È COMPOSTO DA:

IL SET È COMPOSTO DA:

- 1 pentolino grande con coperchio Ø 19 x 11,2 cm
- 1 pentolino piccolo con coperchio Ø 16,6 x 8,9 cm
- 1 padella Ø 19,5 x 4,5 cm
- 1 mestolo in legno
- sacchetto custodia



COOK SET ALU 1

Art. 0802021N

€ 22,50



220 g

**Popote in alluminio per una persona, composta da:**

- 1 tegame Ø 18,5 cm
- 1 casseruola Ø 13,5 cm - 0,4l
- 1 coperchio Ø 13,5 cm
- 1 piatto fondo Ø 18 cm
- 1 tazza

POTGRIP

Art. 0802020N

€ 6,90

80 g



Pinza prendipentole superleggera in alluminio.

**WINDSTOPPER**

Art. 0802019N

€ 27,50

77,5 x 26 cm

210 g

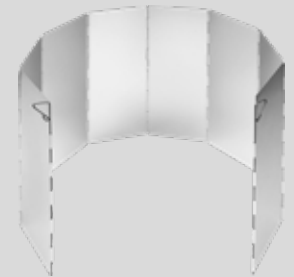

Paravento pieghevole in lamelle di alluminio per fornelli Outdoor.

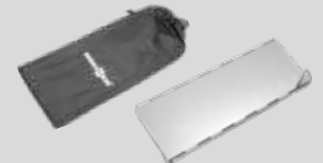
**UNILID**

Art. 0806027N

€ 20,50

170 g



Coperchio speciale adatto per pentole con diametro da 16 a 22 cm. Utilizzabile anche come scolapasta.

**TOASTER**

Art. 0706019N

€ 15,50

Ø 22 cm

150 g



Griglia tostapane pieghevole per fornelli a gas. Con piastra in acciaio.

**THERMATE**

Art. 0708049N

€ 13,90

Ø 16 cm

200 g

Piastra di cottura in acciaio per fornelli a gas.



GAS ITEMS

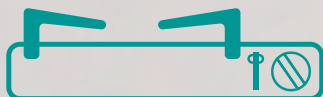

**FORNELLI
ACCESSORI GAS**



CUCINARE COL GAS

Cucinare con il gas all'aperto è di norma semplice, facile e pulito. Ci sono comunque alcune importanti regole da non dimenticare:

- E' vietato introdurre bombolette gas negli aerei
- Verificare che a destinazione siano acquistabili delle bombolette gas adatte
- Con l'aumentare dell'altezza sul livello del mare, diminuisce l'efficienza dei fornelli a gas
- Anche temperature sotto zero riducono la capacità di apparecchi a gas
- Usare sempre un paravento
- Durante la cottura usare possibilmente sempre un coperchio, per evitare che il calore si disperda

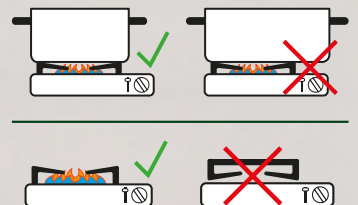



PIEZO IGNITION

FLAMINA ULTRACOMPACT S

Art. 0708011N

€ 28,90

10,5/15,5 x 10,5/15,5 x H 8 cm

8 x 8,5 x H 9,5 cm

3 kW

238 g

Mini-fornello gas pieghevole realizzato in resistente acciaio e con braccetti di supporto dentellati salvaspazio. Dotato di ottimo bruciatore, manopola di regolazione della fiamma e di accensione piezoelettrica integrata. Praticissimo da trasportare e riporre nel suo contenitore in materiale plastico.



FLAMINA ULTRACOMPACT L

Art. 0708012N

€ 54,50

Ø 17,5 / 18 cm x H 9,5 cm

Ø 9,5 cm x H 9,5 cm

3,5 kW

374 g

Fornello gas pieghevole ultraleggero in acciaio per camping ed Outdoor. Completo di accensione piezoelettrica e valvola di collegamento con manopola di regolazione della fiamma. Facile da riporre e trasportare nella sua pratica sacca custodia.



OUTDOOR LIFESTYLE



GAS

DEVIL HEATER SD

Art. 0708025N

€ 111,90

31,5 x 17 x H27,5 cm

1,5 kg

1,2 kW



Stufetta gas portatile con pannello radiante a raggi infrarossi. Accensione piezoelettrica. Funzionamento con bombole gas munite di valvola normalmente reperibili in commercio (non incluse nella fornitura). Consumo: 90 g/h

INOX
Stainless Steel

DEVIL

DOUBLE FLAME

SAFETY DEVICE
THERMOCOUPLE



DEVIL

Art. 0708013N

€ 46,90

P 30 mbar - without flame failure device

37,2 x 28,6 x 12,5 cm

P 2,2 kW

2 kg



DEVIL SD NG

Art. 0708043N

€ 59,90

P 30 mbar - with flame failure device

37,2 x 28,6 x 12,5 cm

P 2,2 kW

2 kg



Fornello con accensione piezoelettrica integrata e bruciatori in alluminio. Flusso del gas regolabile. Completo di pratica valigetta di trasporto. Funzionamento con cartucce gas.

Fornello gas portatile a cartuccia munito di manopola di regolazione della fiamma, di accensione piezoelettrica integrata e di termocoppia di sicurezza. La piastra di supporto pentole ed il coperchio del vano cartucce sono realizzati in resistente acciaio inox di facile manutenzione. Ottima erogazione della potenza mediante speciale bruciatore a doppia fiamma.

CARATTERISTICHE:

- Corpo realizzato in metallo verniciato con piastra di supporto pentole e coperchio per vano cartucce in acciaio inox
- Regolazione individuale della fiamma
- Con termocoppia di sicurezza
- Accensione piezoelettrica integrata
- Completa di robusta valigetta in materiale plastico per il trasporto



DEVIL HEATSTAR

Art. 0708040N

€ 18,50

15,5 x Ø 11,5 cm

320 g



Stufetta radiante per fornelli a gas Devil. Trasforma una normale fiamma generata dal fornello in energia termica. Costruzione in acciaio inox resistente alle alte temperature. Montaggio semplice e rapido mediante attacco a baionetta.



GAS

INOX
Stainless Steel

DEVIL MEGAGRILL

Art. 0708042N

€ 139,90

46 x 34,5 x 10 cm

2,2 kW

4,9 kg

Il Devil Megagrill è ideale come grill da tavolo mobile per il camping o i picnic, ma può essere perfettamente utilizzato anche a casa sui balconi o sulle terrazze. Il grill viene alimentato di serie con cartucce a valvola molto compatte da 227 g disponibili in commercio. Il corpo è realizzato in robusto metallo verniciato a polvere e contiene al suo interno un potente bruciatore a doppio tubo, che viene attivato tramite un'accensione piezoelettrica e può essere regolato in modo ottimale tramite un pomello di controllo. Una piastra grill di alta qualità in alluminio pressofuso con rivestimento antiaderente ed una superficie di grigliatura di 34,5 x 28,5cm permette di fornire facilmente cibo alla griglia a 2/3 persone. Sono inclusi anche una grande padella con coperchio in vetro e una pratica borsa per il trasporto e la custodia.



POWERGAZ 227

Art. 0708021N

€ 3,60

227 g

Bombolette gas butano/propano valvolate. Conforme alla normativa UN 2037.



POWERGAZ 450

Art. 0708036N

€ 7,90

450 g



GAS



DEVIL 450

Art. 0708014N

€ 82,90

35,5 x 22,6 x H23 cm

30,5 x 22,6 x H12 cm

2,4 kW

1,85 kg

Fornello a gas portatile con gambe pieghevoli. Utilizza cartucce filettate da 450 g. Include una valigetta in plastica per il trasporto.

CARATTERISTICHE:

- Consumo di gas: 175g/h
- Involucro (parte inferiore): plastica PBT ad alta resistenza
- Involucro (parte superiore): piastra superiore in metallo verniciato a polvere ad alta temperatura
- Griglia anticivolo in acciaio inox resistente al calore
- Raccordo di ingresso basculante per un facile montaggio della cartuccia di gas
- Manopola di sicurezza a doppio movimento con dispositivo di accensione piezoelettrica
- Controlli multifunzione integrati per un utilizzo sicuro
- Valvola/regolatore per mantenere stabile la fiamma e per prevenire il flare-up
- Gambe pieghevoli in acciaio inox

DEVIL DOUBLE GRILL

Art. 0708017N

€ 149,50

 67,9 x 28,6 x H12,5 cm + Plate 53 x 28 x H2,6 cm

 2x 2,2 kW

 7,1 kg



INOX
Stainless Steel

GRILL PLATE INCLUDED



Fornello gas a cartuccia a 2 fuochi con piastra grill in fusione di alluminio.



DEVIL PLANCHA FLAT

Art. 0708027N

€ 26,50

 25,5 x 24,4 x 2,2 cm

 620 g

Piastra grill di alta qualità con una superficie liscia antiaderente e un fondo appositamente progettato, che garantisce una buona tenuta su tutte le stufe a gas Devil a cartuccia.



DEVIL PLANCHA RIBBED

Art. 0708029N

€ 26,50

 25,5 x 24,4 x 2,2 cm

 620 g

Piastra grill di alta qualità con una superficie rigata antiaderente e un fondo appositamente progettato, che garantisce una buona tenuta su tutte le stufe a gas Devil a cartuccia.



DEVIL SQUARE PAN

Art. 0708026N

€ 46,50

 24 x 22 x H6,7 cm

 700 g

Casseruola quadrata in alluminio con rivestimento antiaderente, maniglie integrate e pratico coperchio in vetro. Il fondo appositamente progettato garantisce una tenuta sicura su tutti i fornelli a cartuccia a gas della linea Devil. Costruzione di alta qualità con bordi sagomati che impediscono la deformazione causata dal calore.



DEVIL GRILL PLATE

Art. 0708019N

€ 27,50

 Ø 31 cm

 400 g

Griglia per fornello Devil.





STOVE

COLLECTION



MAGMA

Art. 0708050N

€ 62,90

- p** 30 mbar
- 43 x 27 x H8 cm
- P** 2x 1,6 kW
- 1,42 kg

Fornello gas a 2 fuochi stabile e compatto. La struttura è in metallo verniciato a polvere con griglia di appoggio in nickel cromato resistente a deformazioni.

PHOENIX 30

Art. 0708052N

€ 78,50

- p** 30 mbar - without flame failure device
- 45,9 x 29,6 x H8,2 cm
- P** 2x 1,2 kW
- 1,6 kg

Fornello a gas a 2 fuochi con bruciatori regolabili. Resistente struttura in metallo verniciato a polvere. Funzionamento con bombole a gas.

PHOENIX 50

Art. 0708056N

€ 78,50

- p** 50 mbar - without flame failure device
- 45,9 x 29,6 x H8,2 cm
- P** 2x 1,2 kW
- 1,6 kg



**PULSE
IGNITION**

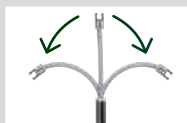

**FLEXIBLE NECK
360° ROTATE**

FIRESTICK

Art. 0712135N

€ 16,90

- 23,5 x 1,5 x 1,5 cm
- 75 g



Accendino ricaricabile USB con braccio flessibile ed interruttore integrato. La soluzione pratica, sicura e sostenibile per accendere fornelli e grill a gas. Corpo in metallo. Completo di cavetto di ricarica micro-USB.

ARISTO



ARISTO 2/30

Art. 0708053N

€ 79,90

P 30 mbar - without flame failure device

✎ 51 x 31 x 12 cm

P 2x 1,6 kW

👤 4,6 kg



SAFETY DEVICE
THERMOCOUPLE

ARISTO 3/30

Art. 0708057N

€ 107,50

P 30 mbar - without flame failure device

✎ 51 x 31 x 12 cm

P 2x 1,6 kW + 1x 1 kW

👤 5 kg



SAFETY DEVICE
THERMOCOUPLE

Fornello gas a 2 o 3 fuochi con base e coperchio in metallo verniciato a polvere.
Doppio raccordo di collegamento: filettato 1/4" sx o portagomma.



ARISTO BAG

Art. 0708039N

€ 15,90

✎ 62 x 33 x 11 cm

Pratica sacca custodia e da trasporto per il fornello a gas Aristo.
Adatto per i modelli a 2 e 3 fuochi. Materiale 100% poliestere.



GAS REG

GAS REG D



Regolatori a gas per bassa pressione, adatti per bombole gas germaniche con un peso lordo fino a 14 kg. Solo per utilizzo per campeggio (grill a gas, fornelli, lampade, ecc.).

GAS REG



Regolatore gas per bombole da campeggio. Con dispositivo di sicurezza anti-rottura del tubo. Testato DIN-DVGW.

GAS REG ITA



Regolatore gas per bombole di fabbricazione italiana. Testato IMQ.

GAS KIT

Kit di collegamento composto da un regolatore a bassa pressione con taratura fissa (30 mbar), 1,5m di tubo GPL e 2 fascette stringitubo.
0712168N -> Adatto per bombole attacco Italia.
0712170N -> Adatto per bombole attacco CG.



GAS KIT

Art. 0712168N

€ 18,50



GAS KIT CG

Art. 0712170N

€ 20,90

p



PACK

		<i>p</i>		PACK	
GAS REG 50 D	Art. 0712059C	50 mbar	1/4" L	1X	€ 13,50
GAS REG 30 D	Art. 0712063C	30 mbar	1/4" L	1X	€ 13,50
GAS REG 50	Art. 0712157C	50 mbar	1/4" L	1X	€ 13,90
GAS REG 30	Art. 0712158C	30 mbar	Ø 8 mm	1X	€ 15,50
GAS REG ITA	Art. 0712243C	30 mbar	1/4" L - Ø 8 mm	1X	€ 12,50

GAS REG CARTRIDGE



Art. 0712078N

€ 9,90

p 30 mbar



Art. 0712079N

€ 16,50

p 50 mbar

Gruppo regolatore che consente di alimentare apparecchi gas a bassa pressione mediante cartucce gas filettate EN417 evitando di dover trasportare pesanti bombole gas. Disponibile in 2 versioni.
Versione 30mbar: attacco portagomma, senza tubo gas
Versione 50mbar: attacco 1/4' sx, con tubo gas



CONNECTOR

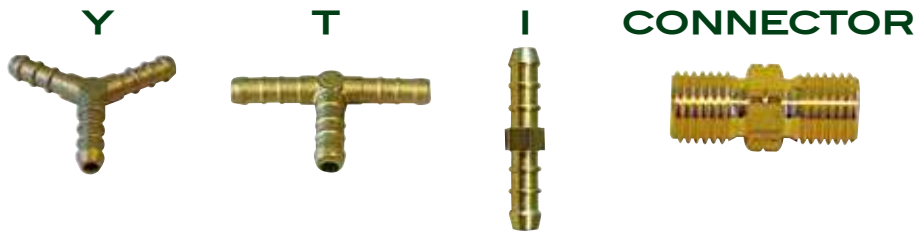

Raccordo portagomma.

			PACK	
CONNECTOR Y	Art. 0712014C	3x Ø 8 mm	1X	€ 6,90
CONNECTOR T	Art. 0712029C	3x Ø 8 mm	1X	€ 5,50
CONNECTOR I	Art. 0712224C	2x Ø 8 mm	1X	€ 4,50
CONNECTOR	Art. 0712270C	2x 1/4" L	1X	€ 5,50

CALIBER

Art. 0712076N

€ 7,50



Praticissimo adattatore per utilizzare le diffusissime cartucce gas 227g come bombolette gas filettate.



ADAPTOR ITA



Adattatore da connessione.



			PACK	
ADAPTOR ITA	Art. 0712251C	1/4" L - Ø 8 mm	1X	€ 5,50
ADAPTOR ITA-CG	Art. 0712011C		1X	€ 7,90
ADAPTOR ITA-DE	Art. 0712080C		1X	€ 7,90



G-HOSE



Tubi gas per collegamento a regolatore bassa pressione. Da utilizzare con grill a gas, fornelli, frigoriferi, lanterne, ecc. Resistente fino a -20°C.

				PACK	
G-HOSE 100	Art. 0712124C	100 cm	1/4" L - 1/4" L	1X	€ 9,90
G-HOSE 200	Art. 0712074C	200 cm	1/4" L - 1/4" L	1X	€ 13,50
G-HOSE 300	Art. 0712075C	300 cm	1/4" L - 1/4" L	1X	€ 16,90



G-HOSE ITA

Art. 0712248N

€ 3,50

 Ø int. 8 mm x 50 m

Tubo gas in PVC rinforzato. Conforme alla normativa UNI-CIG. Omologato.



HOUSEHOLD



**CONTENITORI E BACINELLE
PORTARIFIUTI
STENDIBIANCHERIA**



MY CAMPER MY HOME



Nelle pagine seguenti vi presentiamo pratiche innovazioni per la gestione domestica del vostro veicolo ricreazionale. L'obiettivo è di fare in modo che in camper ci si senta a proprio agio come se si fosse a casa propria e questo, ovviamente, senza dover rinunciare alle comodità di tutti i giorni. Perché una cosa è chiara a tutti i campeggiatori: la casa viaggia sempre con noi e deve essere curata di conseguenza.

NE RISULTA UNA MOLTIPLICITÀ DI DOMANDE:

- Qual è il modo migliore per lavare le mie stoviglie?
- Come evitare odori fastidiosi all'interno del veicolo?
- Quali soluzioni sono disponibili per conservare piatti e bicchieri in modo sicuro?

E molto altro ancora a cui cerchiamo di dare una risposta con suggerimenti focalizzati su prodotti e soluzioni innovative - con il chiaro obiettivo di dare un contributo attivo per rendere la vacanza in camper il più piacevole possibile.



VINIS

Art. 0203051N

€ 9,50

V 14 l

400 g



Secchio multiuso in plastica alimentare.



CLEO NG

Art. 0203063N

€ 11,50

V 13 l

35 x 36 x 18 cm

430 g



Bacinella multiuso con manici pieghevoli.

for Vinis only



OPTIONAL

VINSERT

Art. 0203052N

€ 8,50

Ø 33 cm

220 g



Inserto per secchio multiuso Vinis. In plastica ad uso alimentare.

VINCAP

Art. 0203058N

€ 8,50

Ø 36,3 x H2,3 cm

190 g



Coperchio in materiale plastico per secchio multiuso Vinis.



12 L



POOL

Art. 0812011N

€ 28,90

V 12 l

29 x 29 x 16 cm

280 g

Polyester / PVC

Lavello pieghevole con bordo rinforzato.

16 L



POOL ROUND

Art. 0812010N

€ 32,50

V 16 l

Ø 33 x 25 cm

400 g

100% PVC

Secchio rotondo pieghevole con bordi rinforzati e pratico organizer ad aggancio.

ASSORTED



MERLIN

Art. 0203071N

€ 12,90

V 14 l



Cesto multiuso in materiale plastico flessibile e ad uso alimentare.



BUCK

Art. 0812012N

€ 21,50

V 8 l

Ø 25 x 23 cm

450 g

Secchio pieghevole in nylon.



INFO

I casalinghi pieghevoli sono un'alternativa salvaspazio alle tradizionali ciotole, secchi e bacinelle e non dovrebbero mancare in nessuna delle moderne attrezzature per camper. Sono molto facili da ripiegare, versatili e, soprattutto quando lo spazio è limitato, ideali per lo stivaggio. Per poterlo utilizzare, è sufficiente esercitare una piccola pressione sul fondo. Tutti i prodotti Brunner-FoldAway possono essere ripiegati con la stessa facilità dopo l'uso.

CARATTERISTICHE GENERALI DEL PRODOTTO:

- Materiale: Plastica PP/TPU a stabilità dimensionale
- Leggero
- Stivaggio salvaspazio
- Facile da pulire
- Durevole
- Sicuro da usare



VINIS FOLD-AWAY

Art. 0203062C.C9N

€ 20,90

- V 14 l
- Ø 38 x H23 (+24) cm
- Ø 40 x H10 cm
- 670 g

Paniere collassabile realizzato in materiale plastico TPE resistente al calore, alle rotture e facile da pulire. In caso di inutilizzo si ripiega in modo compatto.

CARATTERISTICHE:

- Adatto per uso alimentare
- Resistente al calore fino a 125°C
- Resistente al gelo
- Con maniglia da trasporto

COLOR



CLEO FOLD-AWAY

Art. 0203064C.C9N

€ 20,90

- V 13 l
- 35,3 x 36,3 x H17 cm
- 35,3 x 36,3 x H6,5 cm
- 640 g

Bacinella collassabile Cleo FoldAway. Realizzata in materiale TPE/PP di alta qualità con comode maniglie pieghevoli.

COLOR



FOLD-AWAY

for Vinis Fold-Away only



OPTIONAL

VINCAP FOLD-AWAY

Art. 0203065N

€ 5,90

- Ø 38 x 2,5 cm

Coperchio in materiale plastico (100% PP) per paniere Vinis Fold-Away.



IRIS FOLD-AWAY

Art. 0203067N.C59

€ 13,50

- V 9 l
- Ø 37,5 x H14 cm
- Ø 37,5 x H5 cm
- 430 g

Lavello pieghevole costruito in resistente materiale plastico. Molto compatto da riporre e facile da trasportare grazie allo speciale sistema Fold-Away.

FOLD-AWAY



DRUM 10 FOLD-AWAY

Art. 0203069N

€ 16,90

✓ 10 l

🔒 Ø 32 x H25 cm

🔒 Ø 32 x H7 cm

📏 610 g

COLOR



Bacinella pieghevole in plastica robusta. Il pratico sistema FoldAway permette di ripiegare in modo compatto e di risparmiare spazio.

DRUM 15 FOLD-AWAY

Art. 0203074N

€ 22,90

✓ 15 l

🔒 Ø 36 x H28 cm

🔒 Ø 36 x H8,2 cm

📏 710 g

COLOR



Bacinella pieghevole in plastica robusta. Il pratico sistema FoldAway permette di ripiegare in modo compatto e di risparmiare spazio.



HOLDALL FOLD-AWAY

Art. 0203070N

€ 16,90

✓ 16 l

🔒 46,1 x 34,2 x 18,4 cm

🔒 46,1 x 34,2 x 4,9 cm

📏 550 g

COLOR



Bacinella pieghevole in plastica robusta. Il pratico sistema Fold-Away permette di ripiegare in modo compatto e di risparmiare spazio.

LOTUS FOLD-AWAY

Art. 0203068N

€ 24,90

✓ 36 l

🔒 54 x 39 x 24 cm

🔒 54 x 39 x 7,1 cm

📏 770 g

COLOR



Lavello pieghevole costruito in resistente materiale plastico. Molto compatto da riporre e facile da trasportare grazie allo speciale sistema Fold-Away.



TANQ FOLD-AWAY

Art. 0203066N.C50

€ 20,90

V 9 l

🔒 30,5 x 30 x 20 cm

🔒 30,5 x 30 x 6 cm

👤 500 g



Lavello pieghevole realizzato in robusto materiale plastico con maniglie per il trasporto integrate e scolo chiudibile mediante tappo. Molto compatto da riporre e facile da trasportare grazie allo speciale sistema Fold-Away.

BOWLIN



TPE / ABS

FOLD-AWAY



BOWLIN 20	Art. 0203076N.C20	Ø 20 x 8 cm	Ø 20 x 2,3 cm	155 g	€ 10,50
BOWLIN 22	Art. 0203077N.C20	Ø 22 x 8,5 cm	Ø 22 x 2,5 cm	198 g	€ 11,50
BOWLIN 25	Art. 0203078N.C20	Ø 25 x 10 cm	Ø 25 x 3 cm	283 g	€ 12,50

Ciotole pieghevoli salvaspazio in PP-TPR resistente al calore con bordo in plastica perimetrale. Compatte e leggere. Molteplici usi. Adatte per alimenti e lavabili in lavastoviglie. Disponibili in 3 misure.

NEW 2023



PURA

Art. 0420030N

€ 8,90

🔪 Base Ø 10 x H3 cm - Brush Ø 8 x H12 cm

👤 132 g

🔲 TPR / Polycarbonate / ABS

Spazzola per lavaggio stoviglie con serbatoio del detersivo integrato. Ideale per una pulizia efficace e delicata di stoviglie e pentole. Munita di speciale pulsante che aziona una piccola pompa inserita nel corpo della spazzola, permettendo un dosaggio mirato del detersivo da utilizzare.

CARATTERISTICHE:

- Corpo spazzola in robusto materiale plastico
- Serbatoio detersivo integrato con pulsante di dosaggio
- Con pratico piattino d'appoggio



FOLD-AWAY GLASS

Art. 0830410N

€ 7,50

V 200 ml

🔪 Ø 8 x 1,5/8 cm

COLORS

C30 C34

FOLD-AWAY

Bicchiere pieghevole in silicone.



FOLD-AWAY FUNNEL

Art. 0830414N

€ 9,90

🔪 Ø 12 x 4/13,5 cm

COLORS

C30 C34

FOLD-AWAY

Imbuto pieghevole in silicone.



DROPPER FOLD-AWAY

Art. 0420040N

€ 27,90

 36,5 x 31 x H12 cm

 36,5 x 31 x H6 cm



Scolapiatti collassabile con portaposate. Realizzato in materiale plastico.



DRIPDISH 90

Art. 0420037N

€ 17,50

 49,5 x 34 x 8,8 cm

 850 g



Scolapiatti triangolare a 2 elementi realizzato in resistente materiale plastico. Ideale per l'utilizzo in spazi ristretti.



DIARID

Art. 0420029N

€ 42,50

 37 x 33 x 17,2 cm

Bacinella scolapiatti con involucro in materiale plastico e griglia in metallo. Completa di portaposate amovibile e scarico incorporato.



PANDORA

Art. 0404021N

€ 11,90

Resistente portabevande in plastica per bottiglie.

CARATTERISTICHE:

- Con staffa di fissaggio flessibile
- Ideale per auto e camper
- Adatto per bottiglie fino a 2 litri





TRIO

Art. 0420004N

€ 19,50

 Ø 28 x H77 cm

 Ø 28 x H4 cm

 300 g

Portaoggetti pensile. Composto da tre cestini inseribili in metallo.



FOOD COVER

Art. 0420009N

€ 5,90

 34 x 34 x 22 cm

 40 g

Zanzariera coprivivande in fitta rete. Telaio pieghevole.



GLASS BASE

Art. 0830001N

€ 6,50

PACK 6X

Portabicchieri in plastica. Adatto per bicchieri in plastica da 200 ml. Colori assortiti.



RESPECT YOUR HOSTS



BIO BOY COMPACT

Art. 7427015N € 15,50

32,5 x 28,5 x H66 cm

32,5 x 28,5 x H7 cm

650 g

Telaio portarifiuti smontabile realizzato in materiale plastico. Adatto per sacchetti rifiuti fino a 50 litri.



BIO BOY NG

Art. 7427017N € 18,50

32,5 x 28,5 x H66 cm

32,5 x 28,5 x H7 cm

650 g

Telaio portasacchetto rifiuti con scomparto portasacchetti. Struttura in materiale plastico. Completo di 10 sacchetti portarifiuti.

Set 3pcs



FIXING SET



EASY SETUP

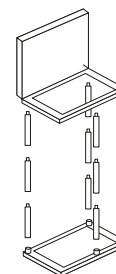

BIO BOY DIFCOL

Art. 7427013N € 44,90

99 x 28,5 x H66 cm

32,5 x 28,5 x H22 cm

2,1 kg

Telai portasacchetto rifiuti modulari per la raccolta differenziata. Realizzati in materiale plastico con coperchi differenziati per colore. Montaggio e smontaggio semplici e rapidi. Facili da riporre e trasportare. Adatti per sacchi fino a 50l di volume. In set da 3 pezzi.



COMPACT STORAGE





PLITTER

Art. 7427026N € 23,50

- 🔒 32 x 27,5 x H38,5 cm
- 🔒 31 x 38 x H6,5 cm
- 🔒 1,65 kg

Cestino per rifiuti con struttura pieghevole in materiale plastico.



BOGO

Art. 7427019N € 14,90

- 🔒 27,5 x 35,5 x H36,5 cm
- 🔒 27,5 x 4,5 x 48 cm
- 🔒 300 g

Telaio portarifiuti pieghevole in materiale plastico.



SNAPSTER

Art. 7427028N € 11,50

- ✂️ 37,5 x 12,5 cm
- 🔒 100 g

Portasacchetti rifiuti con telaio in materiale plastico a chiusura automatica. Montaggio semplice e rapido a porte, ante e pareti.



TRAPSY

Art. 7427035N € 8,90

- ✂️ 13,9 x 10,8 x 4,5 cm
- 🔒 85 g

Pratico portasacchetti per rifiuti utilizzabile in molteplici situazioni: veicoli ricreazionali, camping, nautica, cucina, bagno. Realizzato con telaio in materiale plastico a chiusura automatica bloccadodori. Utilizzo anche con una mano sola. Montaggio semplice e rapido. La fornitura comprende 20 sacchetti portarifiuti (capacità 3,5l ca).



TRAPSY BAGS

Art. 7427079N € 4,50

- PACK 20X
- 3,5l

Sacchetti di ricambio per portarifiuti Trapsy.



NEW
2023



PILLAR FOLD-AWAY

Art. 7427022N

€ 18,90

25,5 x 18,5 x H29 cm

25,5 x 9,5 x H29 cm

620 g

PP - TPR

8 l

Cestino portarifiuti con coperchio ad apertura manuale, caratterizzato da una struttura pieghevole Fold-Away che in caso di inutilizzo consente di ridurre il suo volume d'ingombro di più del 50%. Corpo in resistente materiale termoplastico con fascia in TPR. Utilizzo come portarifiuti indipendente da pavimento oppure appeso a pareti, porte o ante.



FOLD-AWAY

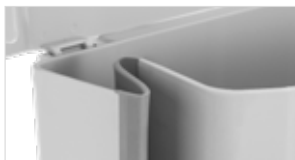

NOT INCLUDED

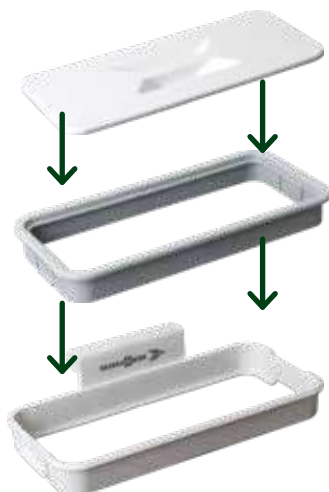

ONE WAY

Art. 7427020N

€ 8,90

23,7 x 11 x 2,9 cm

138 g

PP

One Way è un pratico portarifiuti utilizzabile a mani libere, che si aggancia a qualsiasi cassetto o mobiletto. Il telaio a clip intelligente garantisce un fissaggio sicuro dei sacchetti di plastica. One Way è perfetto per mantenere la cucina e il bagno puliti e in ordine.

CARATTERISTICHE:

- Utilizzo a mani libere
- Intelligente clip telaio
- Custodia robusta in plastica
- Montaggio facile e senza viteria
- Lavabile in lavastoviglie
- Con coperchio
- Per sacchetti della spazzatura da 30 l

EASY
INSTALLATION



NO SCREWS OR
INSTALLATION



**PILLAR**

Art. 7427021N

€ 18,50

22/26,5 x 9/12 x H30 cm

380 g

100% PP

5,1 l

COLOR

C06 C00



Cestino pensile con coperchio ad apertura manuale dal design curato, innovativo e funzionale.

MONTAGGIO SEMPLICE MEDIANTE:

- Supporto di montaggio da avvitare a pareti o ante armadi
- Avvitamento

**PILLAR XL**

Art. 7427025N

€ 27,90

31,5 x 18 x H31,5 cm

476 g

100% PP

10 l

COLOR

C06 C00



Cestino portarifiuti pensile con coperchio.

MONTAGGIO SEMPLICE MEDIANTE:

- Supporto di montaggio da avvitare a pareti o ante armadi
- Mediante piastra di fissaggio regolabile in altezza da avvitare ad ante e porte
- Con speciale supporto da agganciare alla struttura tubolare dei mobiletti cucina



25 pcs



25 pcs

OPTIONAL**PILLARBAG**

Art. 7427008N

€ 4,50

PACK 25X

5,1 l

Sacchetti in plastica biodegradabile per contenitori portarifiuti Pillar.

**BIO- DEGRADABLE****PILLARBAG XL**

Art. 7427009N

€ 5,50

PACK 25X

10 l



EXPRESS

Art. 7202810N

€ 11,50

Ø 45 cm

Stendibiancheria rotondo in materiale plastico. Con 10 aste ripiegabili e 20 mollette.



JOKER

Art. 7202805N

€ 17,50

Ø 45 cm

Stendibiancheria ovale con 24 mollette in materiale plastico di alta qualità. Gancio di fissaggio con chiusura a molla.



SUN TIME

Art. 7202808N

€ 20,50

70 x 34 cm

Stendibiancheria rettangolare in materiale plastico. Con 34 mollette. Pieghevole.



POPS

Art. 7202824N

€ 9,50

max. 90 cm

102 g



Stendibiancheria con ventose.



RAPID METAL

Art. 7427050C

€ 6,90

40 cm

PACK 1X

Asta con sette ganci spostabili in plastica realizzata in metallo cromato.



ARIAL

Art. 7427054N

€ 12,90

60 x 9,5 cm

Appendino a 8 ganci per caravan.



DRYLINE

Art. 7202799N

€ 5,90

1,5 m

Corda stendibiancheria elastica utilizzabile senza mollette. I singoli indumenti vengono incastrati tra i filamenti elastici attorcigliati su loro stessi. Fissaggio mediante ventose.



BONE DRY

Art. 7202798N

€ 6,90

160 g

Corda stendibiancheria estensibile con 2 ganci di fissaggio alle estremità e 12 mollette in metallo. Lunghezza: 1,9 / 3,5 m.



DRYWHEEL

Art. 7202802N

€ 12,50

5,5 m

Corda stendibiancheria in PP con pratico avvolgitore.

LAUN-TREE 3A





LAUN-TREE 3A

Art. 7202811N

€ 69,50



 121 (x3) x H150 cm

 80 x 25 x 12 cm

 2,3 kg

Stendibiancheria con struttura pieghevole in alluminio anodizzato. Lunghezza complessiva corda: 14 metri.

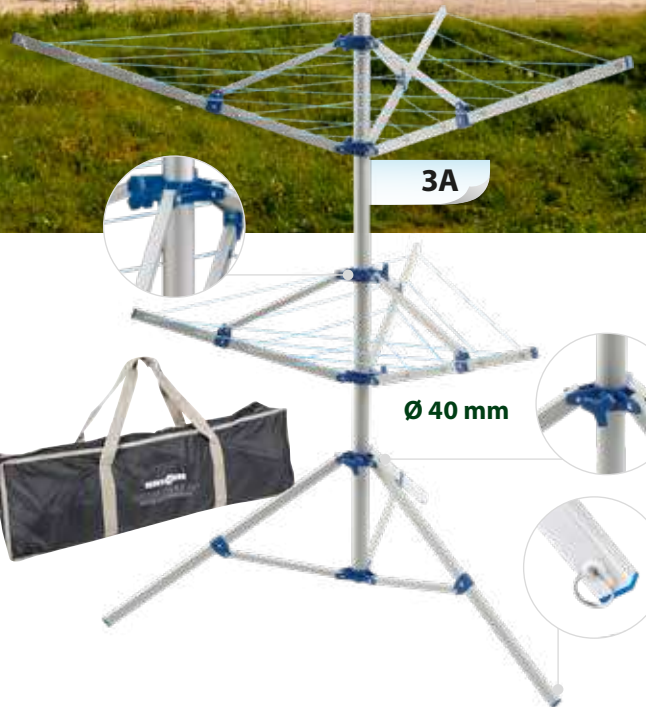



LAUN-TREE 3A WITH EXTENSION

Art. 7202801N

€ 88,50

 121 (x3) x H150 cm

 80 x 25 x 12 cm

 2,8 kg

Stendibiancheria Laun-Tree con supplemento in alluminio per dare più spazio alla biancheria. La lunghezza della corda aumenta a seconda del modello scelto di 7,2/7,5 m.



MARY

Art. 7202829N

€ 13,50

 51 x 26 x 13 cm

 500 g



MARY XL

Art. 7202827N

€ 34,50

 80,5 x 54,5 x 22 cm

 670 g



Stendibiancheria pratico e compatto per le finestre di camper e caravan.



FRANKY

Art. 0203038N

€ 31,90

📏 125 x 26,5 cm

📏 69 x 19 cm

📏 450 g

Scopa per camping con speciale meccanismo di apertura che raddoppia la larghezza utile della spazzola. Dotata di pratica paletta raccogli polvere.



SPIK

Art. 0203035N

€ 11,90

📏 70/118 x 25 cm

📏 340 g

Scopa per tende e verande con pratico manico telescopico.



BENJAMIN

Art. 0203025N

€ 7,90

📏 118 x 25 cm

📏 150 g

Pratica scopa per tende e verande.



TOUCAN

Art. 0203033N

€ 23,50

📏 86/124 x 30 cm

📏 700 g

Scopa per camping con manico telescopico in alluminio.



TIDY

Art. 0203020N

€ 10,50

📏 18 x 21 x 4,5 cm

📏 160 g



Miniset paletta/scopetta di minimo ingombro. Realizzato in materiale plastico.



BUNNY

Art. 0203032N

€ 12,50

📏 27 x 21 x 4,5 cm

📏 170 g



Set paletta/scopetta di minimo ingombro. Realizzato in materiale plastico.



BUTLER

Art. 0203030N

€ 9,50

📏 31 x 22 x 10,5 cm

📏 150 g



Set paletta/scopetta in materiale plastico.



SCOOPY

Art. 0203034N

€ 14,90

📏 34 x 23,5 x 10 cm

📏 175 g

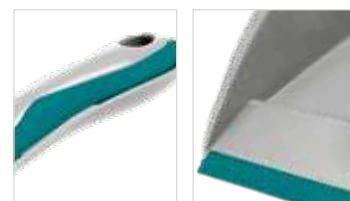

Set paletta/scopetta di ampie dimensioni.

BARRICK SINGLE

Asta di bloccaggio con molla interna e terminali antiscivolo.

**BARRICK DOUBLE**

Doppia asta di bloccaggio per mobiletti e frigoriferi. Telescopico e bloccabile mediante rotazione.



PACK

BARRICK SINGLE S	Art. 0201100N	26/43 cm	2X	€ 16,90
BARRICK SINGLE M	Art. 0201101N	41/71 cm	2X	€ 19,50
BARRICK DOUBLE S	Art. 0201098N	26/43 x H8,5 cm	1X	€ 19,50
BARRICK DOUBLE M	Art. 0201099N	41/71 x H8,5 cm	1X	€ 20,90

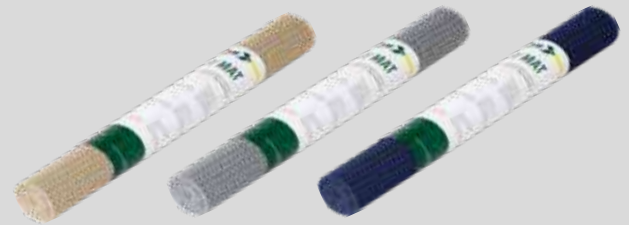
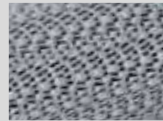

PHTHALATE free

**STAY MAT S**

Art. 0201030N

€ 5,90

COLOR



30 x 150 cm

100% PVC

Stuoia antiscivolo resistente e lavabile fino a 30°C. Tagliabile a piacere.

STAY MAT M

Art. 0201031N

€ 8,90

50 x 150 cm

100% PVC

Stuoia antiscivolo resistente e lavabile fino a 30°C. Tagliabile a piacere.

**SALVAR**

Art. 0420046N

€ 23,50

34 x 25,5 x H6 cm

110 g

Portabicchieri/portatazze universale in materiale espanso. 12 posizioni per bicchieri e tazze di diverse misure.



SOFT FOAMED PLASTIC

**SALVAR SLOT**

Art. 0420048N

€ 27,90

33,5 x 25 x H10 cm

128 g

Portapiatti in schiuma EVA di alta qualità per trasportare fino a 10 piatti in modo sicuro e silenzioso in veicoli ricreativi ed imbarcazioni. Adatto per piatti piani, piatti fondi e piatti da dessert.



SOFT FOAMED PLASTIC

**HOBOX**

Art. 7540204N

€ 20,50

37 x 28 x 12 cm

Mobiletto pensile in materiale plastico. Con fori di aggancio.

**MULTI SHELF**

Art. 7540213N

€ 12,50

27 x 11 x 12 cm

Mensola portaccessori in materiale plastico.



COOLING



**PRODOTTI ELETTRICI AC E DC
BORSE TERMICHE
THERMOS**



POLARYS

COLLECTION



POLARYS FREEZE SZ

SZ30 • SZ40 • SZ50



POLARYS FREEZE DZ

DZ35 • DZ45



POLARYS PORTAFREEZE

8



POLARYS TRAVEL

25 • 28





POLARYS FREEZE

SINGLE ZONE



Nuovo frigo/congelatore bivalente portatile a scomparto unico dal design moderno e compatto. Dotato di resistente corpo in materiale plastico antiurto ad alta capacità isolante ed un display digitale per il controllo della temperatura. Ideale per camper, auto, imbarcazioni.

VANTAGGI:

- Spazioso, per conservare cibo e bevande per più persone
- Elevata velocità di raffreddamento
- Regolazione precisa mediante display digitale
- Design moderno e funzionale
- Ampio range temperatura
- Temperatura minima raggiungibile: -20°C
- Silenzioso, a basso consumo

CARATTERISTICHE:

- Capacità: 30, 40, 50 l
- Voltaggio: 12V / 24V (DC), 220V (AC)
- Potenza totale Ingresso: 45W
- Tecnologia: Compressore

PRESTAZIONI:

• Regolazione della temperatura	tra +20°C e -20°C (surgelamento)
• Refrigerante tipo	R1234yf
• GWP	1430
• Consumo medio di energia AC	(EN62552) 0,28 kWh/24h
• Consumo energetico 12V DC	(ambiente@32°C, interno@5°C) 1,29 Ah/h
• Classe climatica	(EN62552) T/ST/N/SN





30ℓ

**POLARYS FREEZE
SZ 30**

Art. 0826052N

€ 329,90



40ℓ

**POLARYS FREEZE
SZ 40**

Art. 0826053N

€ 389,90



50ℓ

**POLARYS FREEZE
SZ 50**

Art. 0826054N

€ 429,90

58,7 x 36,5 x 36,8 cm

10,9 kg

12/24V DC - 100/240V AC

45W

30 l

58,7 x 36,5 x 43,8 cm

11,6 kg

12/24V DC - 100/240V AC

45W

40 l

58,7 x 36,5 x 50,8 cm

12,3 kg

12/24V DC - 100/240V AC

45W

50 l





POLARYS PORTAFREEZE



8 l

POLARYS PORTAFREEZE

Art. 0826047N

€ 319,90

23,6 x 39,3 x 44,3 cm

7,8 kg

AC 100-240V / DC 12/24V

8 l



ICE PACK



OPTIONAL BATTERY



Frigorifero a compressore 12V/230V portatile concepito appositamente per l'utilizzo in spazi ridotti e per essere facilmente trasportato mediante il suo robusto maniglione pieghevole. Ideale per tutte le attività all'aperto, anche grazie alla possibilità di un'alimentazione mobile mediante l'utilizzo di una batteria al litio (opzionale). Costruzione solida e robusta realizzata con materiali di ottima qualità. Dotato di compressore di ultima generazione che ottimizza il rapporto tra consumo energetico e prestazione raffreddante.

CARATTERISTICHE:

- Batteria staccabile (opzionale) della durata di 4-24 ore
- Compressore di alta qualità per prestazioni di raffreddamento di alto livello
- Protezione della batteria a tre stadi
- Funzionamento DC/AC (AC con alimentatore esterno)
- Design durevole ed antiurto
- Display LCD
- Funzionamento silenzioso
- Maniglione per il trasporto pieghevole



OPTIONAL

POLARYS E-PACK 15

Art. 0826043N

€ 182,90

15600 mAh / 173 Wh

Con la batteria ricaricabile agli ioni di litio E-Pack 15, entrambi i frigobox a compressore della linea Polarys Freeze DZ e Portafreeze possono essere alimentati con energia mobile quando non è disponibile un'alimentazione convenzionale. A seconda del livello di refrigerazione, il contenuto dei frigobox viene mantenuto freddo fino a 8 ore.

Tensione: 11,1V
Capacità: 15600 mAh/173 Wh
Tensione di carica: 12,6V
Tempo di ricarica: 8h ca.

COOLER UP

Art. 0406047N

€ 45,50

45 x 50 x H33/45 cm

63 x Ø 12 cm

1,5 kg

Telaio portafrigo pieghevole e regolabile su due altezze. Completo di custodia.



POLARYS FREEZE

DUAL ZONE

35ℓ







45ℓ



POLARYS FREEZE DZ35

Art. 0826049N





€ 599,00

-  64,7 x 44,1 x 40 cm
-  15,6 kg
-  12/24V DC - 100/240V AC
-  60W
-  35 l (25+10)

POLARYS FREEZE DZ45

Art. 0826050N

€ 639,00

-  64,7 x 50,5 x 40 cm
-  16,5 kg
-  12/24V DC - 100/240V AC
-  60W
-  45 l (32+13)

Grazie ai nostri nuovi refrigeratori/congelatori Dual Zone potrete godervi l'estate in modo estremamente piacevole: Eccezionale capacità di raffreddamento e congelamento allo stesso tempo in un unico dispositivo! Due zone di temperatura regolabili separatamente (Dual Zone) e una batteria staccabile (opzionale) rendono i Polarys Freeze coolers i compagni ideali per tutte le attività all'aperto senza doversi preoccupare dell'alimentazione elettrica. In aggiunta, i refrigeratori/congelatori portatili Polarys Freeze vantano tutta una serie di caratteristiche interessanti e di funzioni utili:

- Batteria staccabile (opzionale) della durata di 4-24 ore
- Due scomparti interni (Dual Zone) con controllo individuale della temperatura
- Compressore di alta qualità per prestazioni di raffreddamento di alto livello
- Protezione della batteria a tre stadi
- Uso DC/AC
- Design durevole ed antiurto
- Display LCD con controllo touch
- App per la regolazione della temperatura
- Funzionamento silenzioso
- Coperchio girevole che permette l'apertura da entrambi i lati
- Testato CE/RoHs
- La fornitura include: unità di raffreddamento, 1 cavo di collegamento CC, 1 cavo di collegamento CA, istruzioni per l'uso

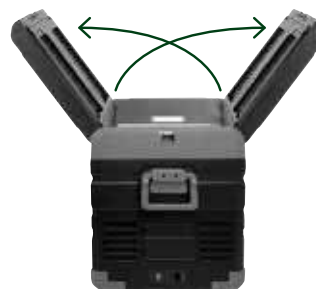

REVERSE DOOR DESIGN MAKES DOOR OPENING MORE FLEXIBLE

PRESTAZIONI:

• Regolazione della temperatura	tra +20°C e -20°C (surgelamento)
• Refrigerante tipo	R1234yf
• GWP	1430
• Consumo medio di energia AC	(EN62552) 0,28 kWh/24h
• Consumo energetico 12V DC	(ambiente@32°C, interno@5°C) 1,29 Ah/h
• Classe climatica	(EN62552) T/ST/N/SN



POLARYS TRAVEL

25l



28l



POLARYS TRAVEL 25

Art. 0826042N

€ 89,90

30 x 39 x H40,7 cm

4 kg

12V DC/230V AC

48 W

25l

Frigobox termoelettrici (sistema Peltier), alimentati mediante accendisigari da auto 12V DC oppure da rete 230V AC. Leggero e facilmente trasportabile. Ideali per la spiaggia, il picnic ed il campeggio.

CARATTERISTICHE:

- Con cavo di collegamento per funzionamento a 12V o 230V
- Adatto per bottiglie da 1,5 l / 2 l
- Coperchio chiudibile con maniglia
- Coperchio elettrico con sistema di raffreddamento integrato
- Facile posizionamento del frigobox in quasi tutti i bauli delle auto o dietro il sedile del conducente o del passeggero

POLARYS TRAVEL 28

Art. 0826044N

€ 99,90

30 x 39 x H45,7 cm

4,5 kg

12V DC/230V AC

48 W

28l



OPTIONAL



COOLPOWER

Art. 0826098N

€ 32,90

13,5 x 5,5 x 3 cm

330 g

100V / 240V - 50/60Hz - AC

72W

Alimentatore 220/12V per frigobox termoelettrici. Tensione in entrata: 240V / 50Hz. Tensione in uscita 12V DC - 6A.

GELBAG

COLLECTION



GELBAG 20

Art. 0824047N

€ 28,90

36 x 23 x H31 cm

Polyester - PEVA

20 l

400 g



GELBAG 30

Art. 0824048N

€ 31,90

41 x 26 x H34 cm

Polyester - PEVA

30 l

450 g



GELBAG 40

Art. 0824049N

€ 34,90

45 x 30 x H36,5 cm

Polyester - PEVA

40 l

500 g



Sia che trascorriate il vostro tempo libero a un picnic, in spiaggia, in viaggio o a una festa, i nuovi Brunner Gelbag sono caratterizzati da un isolamento in schiuma di alta qualità che mantiene cibi e bevande piacevolmente freschi per molte ore. Il rivestimento interno, trattato con microbatteri, è facile da pulire in qualsiasi momento ed è altresì resistente alla formazione di odori, muffe e funghi.

CARATTERISTICHE:

- Design moderno e funzionale
- Parte anteriore con pratica daisy chain
- Schiuma di alta qualità per un efficace isolamento
- Ampio scomparto principale con cerniera per alimenti e bevande
- Tracolla regolabile per un comodo trasporto a mani libere
- Maniglie laterali imbottite
- Incluso apribottiglie
- Fodera interna trattata con antimicrobico per prevenire la formazione di odori, muffe e funghi





AZOfree

25ℓ



NEOPRENE EVA



FREE GO 25

Art. 0824046N

€ 36,90

Borsa termica alla moda, perfetta per le calde giornate estive. Le bevande e gli alimenti rimangono piacevolmente freschi per un lungo periodo grazie ad uno strato isolante di alta qualità. La borsa termica Free Go è particolarmente resistente e molto semplice da pulire dopo l'uso. Ideale per una fantastica giornata in spiaggia o un piacevole pic-nic in montagna.

48 x 23 x 32 cm

Tarpaulin 100% PVC / Alu Foil lining

25 l

820 g



BPAfree

PFOAfree



ICE PACK 100

ICE PACK 140

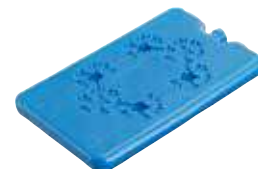
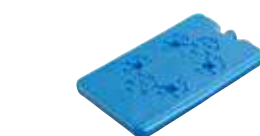

COOLPAD 200

COOLPAD 400

Mini mattonelle di ghiaccio sintetico con involucro in materiale plastico. Perfettamente adatte per mantenere freschi e trasportare cibi e bevande in borse termiche, ghiacciaie o contenitori alimentari in genere. Riutilizzabili senza limite. Non contengono metalli pesanti o ftalati.

Mattonella di ghiaccio sintetico dalla forma extra-piatta. Contenuto: refrigerante non pericoloso.



					PACK	
ICE PACK 100	Art. 0826017N	7,2 x 8,2 x 2 cm	80 ml	4x 100 g	4X	€ 7,90
ICE PACK 140	Art. 0826016N	12 x 12 x 1,3 cm	120 ml	4x 140 g	4X	€ 11,50
COOLPAD 200	Art. 0826018N	16,5 x 11 x H1,5 cm	200 ml	2x 180 g	2X	€ 5,90
COOLPAD 400	Art. 0826019N	25 x 14 x H1,5 cm	400 ml	1x 375 g	1X	€ 5,50



18ℓ



SPECTRACOOOL 18

Art. 0824038N.C9N

€ 49,50

33 x 21 x 29 cm

700D Nylon / Alu foil

18 l

1 kg



AZOfree



Assorted

Borsa termica ideale per le giornate in spiaggia.



25ℓ



SPECTRACOOOL 25

Art. 0824039N.C9N

€ 46,90

45 x 27 x 27 cm

700D Nylon / Alu foil

25 l

1,10 kg



AZOfree



Assorted

Borsa termica ideale per le giornate in spiaggia.

FRIOBAG



12ℓ



20ℓ



30ℓ



34ℓ

Borse termiche di alta qualità, ideale per gite, spiaggia e picnic.

 **AZOfree**



FRIOBAG COMPACT

Art. 0824041N

€ 29,90

 34 x 23 x 8,5 cm

 100% Polyester Jacquard 420D

 12 l

 250 g

FRIOBAG DAYPACK

Art. 0824013N

€ 59,90

 30,5 x 18 x 46,5 cm

 100% Polyester Jacquard 420D

 20 l

 800 g

FRIOBAG OBLIQUE

Art. 0824015N

€ 56,50

 45 x 25 x 33 cm

 100% Polyester Jacquard 420D

 30 l

 850 g

FRIOBAG CLASSIC

Art. 0824016N

€ 58,50

 34 x 31 x 33 cm

 100% Polyester Jacquard 420D

 34 l

 900 g





FOSTER

Art. 0820028N € 26,50

365 g

600 ml



SHOT

Art. 0820055N € 27,50

280 g

750 ml



HYDROLIN STEEL 1000

Art. 0820026N € 12,50

190 g

1000 ml



Bottiglia termica infrangibile realizzata in acciaio inox alimentare 18/8. 100% BPA-free.

Bottiglie portabevande in acciaio alimentare verniciato a polvere. Con tappo a vite a filetto interno e coperchio rivestito in elegante bambu'. Inodore ed insapore. Lavabile in lavastoviglie.

Bottiglia in acciaio inox con elegante superficie lucidata.



ZERO+ 5

Art. 0826002N € 39,90

25,2 x 26,6 x H27 cm

900 g

5 l

ZERO+ 10

Art. 0826004N € 58,50

30,6 x 31,5 x H33,2 cm

1,65 kg

10 l

Thermo-contenitore per bevande con tappo a vite e rubinetto. Design moderno.

CARATTERISTICHE:

- Adatto per bevande fredde e calde (max. 65°C)
- Apertura di riempimento di grandi dimensioni per riempimento e pulizia
- Coperchio filettato
- Utilizzabile anche come secchiello per il ghiaccio
- Rubinetto a tenuta

INOX

Stainless Steel



RICO

Art. 0820052N

€ 20,50

400 g

500 ml

SOFT TOUCH



SILICON

Bottiglia termica sottovuoto con coperchio a tazza.

CARATTERISTICHE:

- Isolamento sottovuoto a doppia parete
- Scocca esterna ed interna in acciaio inox
- Fondo antiscivolo (Antislip)
- Tappo a tenuta
- Versamento facile
- Coperchio a tazza incluso



LEGEND OUTDOOR 500

Art. 0820050N

€ 15,90

270 g

500 ml

LEGEND OUTDOOR 1000

Art. 0820051N

€ 26,50

470 g

1000 ml

Bottiglia termica realizzata interamente in acciaio inox antiurto.



IQUID

Art. 0820034N

€ 48,50

Ø 11 x H31 cm

900 g

1,5l

Bottiglia termica a doppia parete isolante realizzata in acciaio inox alimentare 18/8. 100% BPA-free.



ELECTRICAL PRODUCTS



**PRODOTTI ELETTRICI AC E DC
SPOT E PLAFONIERE
ADATTATORI E PROLUNGHE**



Invertitori di corrente per veicoli ricreazionali, auto, barche e sistemi ad energia alternativa. Inverter a onda sinusoidale modificata.

CARATTERISTICHE:

- Tensione nominale in uscita: AC230V ± 10%
- Frequenza nominale in uscita: 50Hz ± 3Hz
- USB: 5V-3,1A
- Protezione tensione minima
- Protezione corto circuito

ZING 300	Art. 0826060N	16 x 15,5 x 7,5 cm	868 g	10V-15V DC	300W	€ 84,50
ZING 600	Art. 0826061N	19 x 15,5 x 7,5 cm	1 kg	10V-15V DC	600W	€ 115,50
ZING 1200	Art. 0826062N	25,5 x 15,5 x 7,5 cm	1,5 kg	10V-15V DC	1200W	€ 169,90



Ventola di raffreddamento Fusibile Collegamento cavi

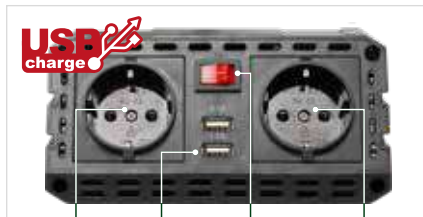

USB charge Schuko USB: 5V-3,1A On / Off Schuko



Ventola di raffreddamento Collegamento cavi



VENTO SWIFT 92
Art. 7164006N € 114,90

- 19,2 x 9,2 x 3 cm
- 350 g
- 12V - 0,5A



VENTO NG 92
Art. 7164011N € 56,90

- 19,2 x 9,2 x 3 cm
- 350 g
- 12V - 0,5A

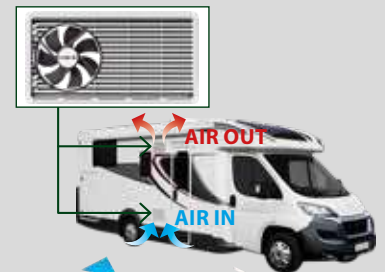

VENTO ELECTRONIC
Art. 7164010N € 57,50

- 26 x 10 x 2,4 cm
- 370 g
- 12V - 0,5A
- 6W

VENTO SWIFT 120
Art. 7164007N € 121,90

- 24,8 x 12 x 3 cm
- 460 g
- 12V - 0,5A

VENTO NG 120
Art. 7164012N € 62,90

- 24,8 x 12 x 3 cm
- 460 g
- 12V - 0,5A

Con il Vento Swift, il ventilatore per frigoriferi è stato completamente reinventato. Il cablaggio del pannello di controllo è stato interamente eliminato e un semplice collegamento all'alimentazione a 12V di bordo è tutto ciò che serve per avviare il dispositivo. Il pannello di controllo, che è dotato di un display touch screen a batteria, consente di utilizzare comodamente tutte le impostazioni della ventola e può essere montato in modo flessibile in qualsiasi punto del veicolo.

Ventilatore per frigo ad alte prestazioni con pannello di controllo (completo di cornice per montaggio a parete). Il rilevamento della temperatura avviene mediante uno speciale sensore. Le staffe di fissaggio ed i cavi collegamento sono compresi nella fornitura.

Ventilatore per frigo a velocità variabile, regolata elettronicamente. Completo di pannello di comando.





App: W8 SYSTEM



W8 2.0

Ø 31 cm



Smartphone not included

W8 2.0

Art. 0712005N

€ 157,50

Ø 29,2/31 x H3,2/4,1 cm

La versione 2.0 della popolare W8-Gascontrol presenta i seguenti miglioramenti ed ottimizzazioni:

- Nuova copertura sviluppata per le celle di carico
- Prolungamento dei cavi di collegamento al vano di ricarica della batteria
- App W8 rivisitata

Il dispositivo elettronico W8 GASCONTROL misura il livello di riempimento delle bombole a gas e lo trasmette via Bluetooth a Smartphone o Tablet con tecnologia Android o iOS. Grazie alla sua altezza molto contenuta il W8 GASCONTROL può essere utilizzato in maniera continuativa nel vano portabombole della stragrande maggioranza di veicoli ricreazionali.

CARATTERISTICHE:

- Adatto per tutte le bombole gas (acciaio, alluminio, plastica, vetroresina) con diametro massimo di 30 cm
- Misurazione rapidissima del livello di riempimento
- Indicazione dell'autonomia
- Lettura del livello di riempimento e dell'autonomia su Smartphone o Tablet
- Tecnologia Bluetooth
- Software compatibile con sistemi Android e iOS
- App per Smartphone o Tablet inclusa (download)
- Funzionamento a batterie (non ricaricabili)
- Involucro in resistente materiale plastico
- Semplice e intuitivo da usare
- Prodotto europeo

CAMPI D'UTILIZZO:

- Veicoli ricreazionali
- Camping e picnic
- Barbecue & grill

ATTENZIONE: IL DISPOSITIVO DI LETTURA (SMARTPHONE, TABLET, ECC.) NON È INCLUSO NELLA FORNITURA!



4X1,5V AA batteries
not included

BATTERY LEVEL

>75%

50%

<25%





WITH BUFFER BATTERY

3-SICUR

Art. 0712002N

€ 103,50

7 x 11 x H4 cm



Dispositivo di rilevazione gas per veicoli ricreazionali dotato di sensore ad alta sensibilità in grado di rilevare propano/butano, monossido di carbonio e gas narcotizzanti. Il dispositivo si calibra automaticamente ed in caso di allarme emette un segnale acustico. Una batteria tampone (opzionale) garantisce la funzionalità del dispositivo anche in caso di mancanza di alimentazione di bordo. 3-Sicur, può essere utilizzato in modo mobile o con installazione permanente. E' dotato di un solo pulsante per accensione, spegnimento, test e reset, luci a led di segnalazione a led e spina a 12V.

INFO

La versione 2.0 della popolare W8-Gascontrol presenta i seguenti miglioramenti ed ottimizzazioni:

- Nuova copertura sviluppata per le celle di carico
- Prolungamento dei cavi di collegamento al vano di ricarica della batteria
- App W8 rivisitata



APP BLUETOOTH CONNECT



Areas of application:



CARAVAN



MOTORHOME



BBQ





MISTRAL UNIVERSAL

Art. 0716020N

€ 37,90

Ø 22cm

0,7 kg

12V



Potente ventilatore a 12V con doppio sistema di fissaggio (piastra a vite o fissaggio a clip). Griglia di protezione cromata Ø 22cm. Collegamento elettrico tramite presa accendisigari.



ATMO RG

Art. 0716014N

€ 41,50

Ø 22 x H13 cm

480 g

3,7V / 4000mAh RG Li-Ion

80 lumen

1

12h Light / 7h Fan



Questa pratica combinazione di ventilatore/lampada ricaricabile fornisce simultaneamente una luce LED brillante e la brezza fresca di un potente ventilatore a quattro pale. Il design funzionale permette il fissaggio del ventilatore sia al tetto che alle pareti di tende e verande mediante la sua maniglia pieghevole e/o il suo gancio.

CARATTERISTICHE:

- 2 livelli di luminosità
- Ventilatore a 4 pale in schiuma espansa (a prova di infortunio) - 2 velocità
- Utilizzabile in 3 posizioni: appeso verticalmente, appeso orizzontalmente, appoggiato ad una superficie piana
- Batterie ricaricabili



MONSUN

Art. 7202818N

€ 24,90

15 x 7 x H18 cm

18,5 x 7 x H10,5 cm

320 g

12V DC

180W



Utilissimo asciugacapelli 12V da viaggio. Design moderno con manico pieghevole salvaspazio. Involucro in resistente materiale plastico. Completo di interruttore ON/OFF, spina per accendisigari e becco per la piega staccabile. La fornitura comprende una pratica custodia per il trasporto.



SCIROQUE 2.0

Art. 7202814N

€ 27,90

14,3 x 5 x 19 cm

300 g

220V + 110V AC

800W



Asciugacapelli compatto con maniglia pieghevole salvaspazio. Può essere utilizzato sia con una tensione di 230V, che con 110V. Corpo in resistente materiale plastico. Con pratica borsa portaoggetti.



AIRTOUCH RG

Art. 0436011N

€ 83,90



22,5 x 14 x H8 cm

1,34 kg

RG

8 bar - 120 PSI



Touch Control



Compressore portatile wireless ricaricabile con batteria agli ioni di litio e presa USB per la ricarica. Dotato di display digitale Touch Screen. Ideale per essere utilizzato ovunque sia richiesto senza la necessità di avere nelle vicinanze una presa elettrica dove collegare il cavo di alimentazione. Perfetto per gonfiare auto, moto, biciclette e palloni.

CARATTERISTICHE:

- Corpo in resistente materiale plastico
- Display digitale
- Batteria agli ioni di litio 2500 mAh
- Presa USB per la ricarica
- Cavo di alimentazione/ricarica USB - lunghezza 1,5 m
- Con adattatore 5V DC / 1A
- Tubo aria in gomma con connettore a sgancio rapido. Lunghezza 60 cm
- Completo di 2 adattatori ed 1 ago sportivo



Touch Control



INFLATOR

Art. 0436010N

€ 20,90

12 x 10 x H11,5 cm

230 g

12V DC

75W

L/min 20 l/min

Gonfiatore e sgonfiatore elettrico 12V con interruttore ON/OFF completo di 3 adattatori.



TEMPEST RG USB

Art. 0436016N

€ 43,90

8 x 7,5 x 10,5 cm

280 g

RG

38 W

L/min 270 l/min

Potente pompa 5V con interruttore ON-OFF. Completa di adattatore USB. Con borsa.



RECHARGEABLE



KERO THERMOSTAT

Art. 7202840N

€ 39,90

15,5 x 15 x H7,3 cm

650 g

230V

500W DC



Termoventilatore compatto in ceramica con elemento riscaldante PTC. Corpo in solido materiale plastico. Ideale per l'uso in caravan, camper o verande. Dotato di un regolatore termostatico. Il ventilatore integrato garantisce un'efficiente distribuzione del calore.

CARATTERISTICHE:

- Protezione anti-surriscaldamento
- Protezione anti-ribaltamento
- Controllo termostatico
- Adatto a locali fino a 10 m²



SOLAN

Art. 7202839N

€ 79,90

21 x 14 x 16 cm

1,5 kg

230V AC - 50Hz

750W / 1500W



Potente stufetta elettrica a ceramica. Utilizzabile anche come ventilatore.

CARATTERISTICHE:

- Involucro in resistente materiale plastico
- Temperatura regolabile senza scatti
- Resistenze in ceramica PTC
- Non brucia la polvere
- Protezione anti-surriscaldamento
- Protezione anti-ribaltamento



FERVOR

Art. 7202843N

€ 19,50

25 x 7 x H37 cm

750 g

230V - 50Hz

400W / 800W



Efficiente stufa alogena a 2 livelli di potenza selezionabili tramite manopola.



CALENSA

Art. 7202842N

€ 54,90



✏ 18 x 15 x 19 cm

📏 255 g

⚙ 220V - 240V - 50/60 Hz

Ⓟ 750W - 1500W

Nuovissimo termoventilatore compatto in ceramica, con elemento riscaldante PTC. Corpo in solido materiale plastico, ideale per l'uso in caravan, camper o verande, è dotato di regolatore termostatico.

CARATTERISTICHE:

- Potenza variabile da 500 a 1000 Watt
- Termostato regolabile
- Fusibile di sicurezza
- Interruttore antiribaltamento
- Protezione da surriscaldamento



BLACKFIRE NG

Art. 7202849N

€ 30,90



✏ 11,3 x 13,4 x H7,5 cm

📏 410 g

⚙ 12V

Ⓟ 150W

Stufetta ad aria 12V.



HOT POINT



WITH AUTOMATIC DETECTION OF THE INDUCTION COOKER, IT WILL NOT START WITHOUT IT



HOT POINT INDUCTION

Art. 7202834N

€ 63,50

28 x 35 x H4,6 cm

2,1 kg

230V - 50Hz

300 - 2000W

Piastra ad induzione di calore portatile con corpo in PP e superficie di cottura realizzata in vetroceramica ad alta resistenza. Perfetta per l'utilizzo in ambito Outdoor e Camping grazie al suo peso ridotto ed ai 9 livelli di potenza (300 - 2000 W) selezionabili mediante interruttore Touch Control e display LED.



HOT POINT

Art. 7202831N.C25

€ 41,90

29,5 x 27 x H7 cm + Plate Ø 18,5 cm

2 kg

230V - 50 Hz

750W

Piastra di cottura elettrica con corpo in metallo verniciato e manopola di selezione potenza a 5 posizioni.







HOT POINT INDUCTION GRILL

Art. 7202833N

€ 139,90

 37 x 27 x H4,8 cm - 41,5 x 27,2 x H3,3 cm (grill plate)

 3,9 kg

 230V - 50Hz

 300 - 2000W



Fornello/Grill portatile elettrico dotato di monopiastra ad induzione. Costruzione solida e dal design moderno realizzata con corpo in PP termoresistente e superficie di cottura in vetroceramica ad alta resistenza. Ideale per l'utilizzo in ambito outdoor e campeggio, grazie a una zona di cottura con 9 livelli di potenza (da 300 a 2000W) selezionabili mediante comandi Touch control e display led. La fornitura comprende una piastra grill in alluminio predisposta per una termodiffusione omogenea, internamente rivestita in ceramica per delle cotture alla griglia davvero eccezionali.



Touch Control



BOWA

Art. 7202847N

€ 31,50

 600 g

 230V - 50Hz

 750W

 1 l

Bollitore acqua elettrico. Esecuzione cordless con grande indicatore di livello acqua.





ASPAIR DUAL NG

VACUUM CLEANER



13 min.



5,5 h



Charging



ASPAIR DUAL NG

Art. 0436025N

€ 79,90

12 x 41/122 x 12 cm

1 kg

Li-Ion 2000 mAh / 11,1 V

100 W / 5,5 kPa

500 ml (powder) / 120 ml (liquids)

13 min



Il potente aspirapolvere Aspair Dual NG è lo strumento ideale per rimuovere qualsiasi tipo di sporco e/o liquido. Grazie al suo design molto maneggevole e compatto, è possibile pulire in poco tempo anche luoghi difficili da raggiungere. Piccoli e grandi residui di sporco vengono facilmente rimossi grazie alla sua grande potenza di aspirazione ed il vostro veicolo, la veranda o il tavolo da pranzo tornano puliti in pochissimo tempo. Utilizzabile perfettamente anche come aspirapolvere da pavimento per mezzo dei tubi di prolunga inclusi nella fornitura.

CARATTERISTICHE:

- Ricaricabile: Batteria Li-ion (funzionamento cordless) con indicatore di carica
- Potenza di aspirazione 5,5 kPa con potente motore a turbina
- Aspirazione a secco e a umido
- Facile da maneggiare grazie al peso ridotto di soli 1,0 kg
- Ricarica tramite caricabatterie 230V o cavo di ricarica 12V (180 cm)
- Filtro HEPA lavabile
- Pulizia a tutto campo: con 4 diversi tipi di accessori
- Inclusi nella fornitura: bocchetta per fessure, spazzola per pulire, spazzola rotonda, bocchetta per liquidi, tubi di prolunga, custodia per il trasporto
- Funzionamento silenzioso
- Capacità del contenitore di 500 ml di polvere o 120 ml di liquido
- Docking station (indipendente e a parete)

VORTIX

Art. 0436020N

€ 38,50

Ø 22 x H24 cm

1,3 kg

12V

120W / 10A



Aspirapolvere ed aspira acqua a corrente continua con struttura in robusto materiale plastico, tubo flessibile e lungo cavo di alimentazione a 12V. Accessori inclusi: bocchetto per fessure, bocchetto per tappeti, adattore per gonfiaggio.





ASPAIR COMPACT 12

Art. 0436026N

€ 43,90

33,6 x 10,5 x 11,5 cm

645 g

12V

75W

500 ml



Potente aspirapolvere 12V ideale per rimuovere qualsiasi tipo di sporco. Grazie ad un design maneggevole e compatto, è possibile pulire luoghi difficili da raggiungere. Piccoli e grandi residui di sporco saranno facilmente rimossi grazie alla sua potenza di aspirazione, così il vostro veicolo, la veranda o il tavolo da pranzo torneranno puliti in breve tempo.

CARATTERISTICHE:

- Alimentazione 12V
- Cavo di alimentazione 3 m con spina per accendisigari
- Potenza di aspirazione 5,5 kPa
- Filtro HEPA lavabile
- Pulizia a tutto campo grazie a diversi tipi di accessori
- Inclusi nella fornitura: bocchetta per fessura, spazzola per pulire, spazzola tonda, custodia per il trasporto



DAYTONA DUO

Art. 7202854N

€ 206,90

56,5 x 35,5 x 61,5 cm

11 kg

230V - 50Hz

250W Washing + 120W Spinning

Questa lavatrice portatile dalle dimensioni compatte e dotata di centrifuga (sistema a doppia vasca) è ideale per lavare la biancheria in spazi compatti come in camper, in caravan o in un mobilhome. Caricamento dall'alto. Semplicemente selezionare la funzione desiderata (lavaggio o centrifuga) e la macchina si arresterà automaticamente non appena il ciclo sarà terminato. Corpo in resistente materiale plastico con coperchio trasparente. Capacità di carico: 3,5 kg in lavaggio (biancheria asciutta) e 1,5 kg in centrifuga. Basso consumo energetico.



DAYTONA

Art. 7202853N

€ 119,90

35 x 36,5 x 50 cm

6 kg

230V - 50Hz

180W

Lavatrice portatile di dimensioni compatte con caricamento dall'alto. Dotata di un resistente involucro in materiale plastico, di un affidabile motore ed un pratico timer. Capacità di carico: 2 kg (biancheria asciutta). Basso consumo energetico.





CONDO

Art. 7530024N

€ 22,90

10,3 x 10,3 x 3,5 cm

80 g

12V

60 lumen

0,24W

Energy class
in process of approval

Plafoniera LED rotonda. Con corpo in plastica, lente di diffusione ed interruttore ON/OFF. Montaggio a parete.



White Light **Red Light**



ORION

Art. 7530003N

€ 25,50

20,5 x 12,5 x 2,9 cm

110 g

12V

280 lumen

21 SMD

3,6W

G

Plafoniera LED ovale per interni con corpo in resistente materiale plastico ed interruttore ON/OFF. Montaggio a parete.

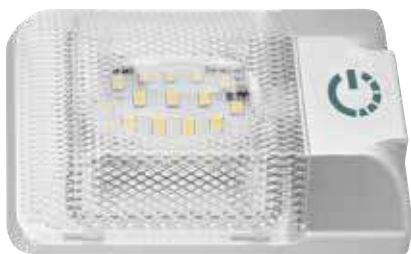

AURIGA

Art. 7530006N

€ 24,90

18 x 12 x 3,8 cm

110 g

12V

280 lumen

24

3,6W

G

Plafoniera con resistente involucro in ABS e lente in PP.



**On-Off
Touch**



LIBRA

Art. 7530007N

€ 31,50

30 x 12,2 x 4 cm

210 g

12V

550 lumen

48

6W

F

Plafoniera con resistente involucro in ABS e lente in PP.



ILUMINA LED 45

Art. 7530032N

€ 28,90

45 x 3,8 x 4,2 cm

180 g

12 V

350 lumen

36

4,3W

ILUMINA LED 60

Art. 7530033N

€ 36,90

60 x 3,8 x 4,2 cm

280 g

12 V

630 lumen

66

6,7W

Energy class
in process of approvalEnergy class
in process of approval

Luce esterna LED per illuminare l'ambiente circostante le porte d'entrata di veicoli ricreazionali. Il corpo realizzato interamente in alluminio, grazie alla sua speciale forma, facilita il deflusso dell'acqua piovana. Schermo in materiale plastico opacizzato per garantire la distribuzione uniforme della luce. Disponibile in 2 lunghezze.



AVENUE

Art. 7530059N

€ 57,90

37 x 5 x 5,5

280 g

12V

355 lumen

10

3W

Lampada LED per esterni ad alta luminosità. Corpo in resistente ABS. Pre-cablata per un montaggio rapido. Angolo di diffusione: 40°.

Energy class
in process of approval

FUNKY LED HP

Art. 7530025N

€ 40,50

Ø 6 x H10 cm

148 g

12V DC

140 lumen

1

3W

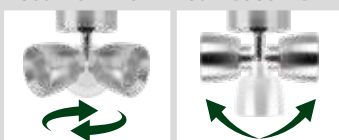
360° ROTATION 180° ADJUSTABLE
Energy class
in process of approval

Spot LED montabile con riflettore orientabile.

FLEXSPOT LED

Art. 7530028N

€ 57,50

Ø 6,5 x H18 cm

190 g

10-30V

650 lumen

1

3W

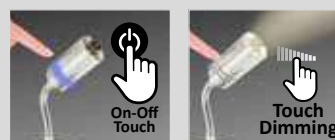

Faretto LED da parete con braccio snodato (10 cm) realizzato in metallo cromato e riflettore in alluminio con interruttore sensibile al tatto. Design moderno ed elegante.









AMBEL



AMBEL COMPACT

Art. 7530026N

€ 52,90

-  50 x 2 x 1,5 cm
-  125 g
-  12V DC - 220V AC
-  500 lumen
-  30
-  7W







 Energy class in process of approval

La versione compatta della lampada Ambel L.

AMBEL L

Art. 7530027N

€ 78,50

-  120,5 x 2,8 x 2,4 cm
-  468 g
-  12V DC - 220V AC
-  1100 lumen
-  180
-  12W

  Energy class in process of approval

Lampada tubolare LED per verande e gazebo. Montaggio ai pali della struttura mediante clips in plastica Ø 22-26 mm.

DIMA TOUCH
ON-OFF
DIMMER 0-100%







SUPPORTS INCLUDED



RAY S

Art. 7530019N

€ 36,90

-  22,5 x 3 cm
-  160 g
-  12V DC
-  150 lumen
-  24
-  2,5W







 Energy class in process of approval



RAY L

Art. 7530020N

€ 52,90

-  45 x 3,5 cm
-  296 g
-  12V DC
-  500 lumen
-  36
-  5W

 Energy class in process of approval

MINI ROCKER
SWITCH



180 DEGREE
SWIVEL

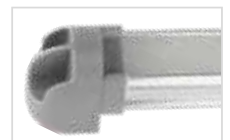

Lampada LED molto luminosa.
Struttura in alluminio rotante.



GLOBE LED

Art. 0720009N

€ 13,90

RECHARGEABLE

Ø 10,4 x H17,3 cm

180 g

3,7V 2400mAh

98-394 lumen

42

21W

8-15 h

 Energy class
in process of approval

Lampada LED a basso consumo energetico realizzata con corpo in resistente ABS e schermo in materiale plastico trans lucente che genera una luce uniforme. Il pulsante ON-OFF integrato permette di selezionare più livelli di intensità luce per illuminare l'ambiente circostante in maniera ottimale. Completa di gancio in metallo per appenderla e presa Micro-USB per la ricarica. Facile da trasportare grazie alle sue dimensioni compatte. Ottima per l'utilizzo Outdoor e Camping.

ATHOME

Art. 7530031N

€ 20,50



12 x 4,3 x 1,7 cm

80 g

Lithum 500mAh 3,7V

240 lumen

12

0,75W

 Energy class
in process of approval

Lampada ricaricabile LED per armadi, entrate, corridoi, dispense, ecc. Corpo in elegante materiale plastico con sensore di movimento a tecnologia PIR integrato. Facilmente ricaricabile mediante presa USB. Montaggio a parete.

3 LIGHTING MODES

AUTO
Motion Sensor
Light

OFF
Turn Light Off

ON
Always Lighting

 120°
3 m

AUTO - PASSIVE INFRARED (PIR)



SIXRAY

Art. 7521011N

€ 39,90

Ø 50 x H25 cm

400 g

230V AC

250 lumen

5W

3h

Lampadario ad ombrello a sei raggi completo di lampadina LED a bulbo con batteria ricaricabile integrata. Completo di cavo di collegamento e interruttore ON/OFF.



COLORS



C06

C21

C30



**DIMMERABLE
0-100%**

SYRMA LED

Art. 7521018N

€ 57,50

230 V

520 lumen

32

Ø 18,5 X H12 cm

350 g

15W

Lampada LED per tende e verande. Corpo pieghevole in silicone (sistema Fold-Away).

CARATTERISTICHE:

- Corpo in silicone
- Moderna tecnologia LED per oscuramento graduale (dimmer)
- Con gancio di sospensione e cavo di collegamento da 5 m
- Sistema di regolazione dell'altezza
- Interruttore ON-OFF



COLORS



C06

C34



ZAZÀ



ZAZÀ DUO

Art. 0205081N

€ 15,50

-  230V AC
-  11 x 6 x 4,5 cm
-  60 g





not included



ZAZÀ DUO 12V

Art. 0205083N

€ 18,50

-  9 x 5 x 4,5 cm
-  80 g
-  12V DC

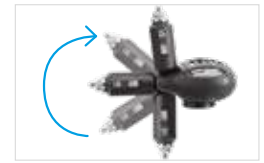

not included



Insetticida elettrico a vaporizzazione con doppia configurazione. Dotato di spina rotante e interruttore ON/OFF. Liquido non incluso.





Insetticida funzionante sia con piastrelle tampone che con pratico vaporizzatore per liquidi insettifughi (non inclusi). Non produce fumo e protegge per 8 ore ca.



FIREFLY

Art. 0205085N

€ 40,50

-  13,1 x 13,1 x H13,6 cm
-  600 g
-  5V DC
-  4W



Zanzarikiller elettronico con lampada LED-UV e ventola di aspirazione incorporata.

CARATTERISTICHE:

- Sicuro ed ecologico: nessun bisogno di repellenti anti-zanzare tossici e malsani
- Nessun odore sgradevole o sibilo fastidioso generato dai sistemi a scossa elettrica
- Zona di aspirazione a 360°: le zanzare vengono attratte dalla luce a LED ed aspirate nel corpo rimovibile tramite il ventilatore aspirante incorporato
- Funziona con una tensione di 5V DC con connessione USB
- Compatto e leggero. Facile da trasportare e posizionare

3in1







WITH UV LIGHT
360-390 nm

MOSLIGHT

Art. 0205086N

€ 34,50

-  8,7 x 8,7 x 13 cm
-  230 g
-  18650 RG (incl.)
-  3W



Praticissima lampada LED per Outdoor a doppia funzione luce/zanzarikiller dotata di batterie al litio ricaricabili. Utilizzabile anche appesa mediante il gancio in metallo pieghevole integrato nell'involucro. Schermo in materiale plastico translucido che trasmette una luce uniforme. Completa di cavetto USB di ricarica.

CARATTERISTICHE:

- Funzionamento mediante batteria ricaricabile 18650
- Corpo in resistente materiale plastico ABS/PC
- Resistente agli spruzzi
- Zanzarikiller a luce UV (360-390 nm)
- Interruttore: ON-OFF (lampada)
- Interruttore ON-OFF (zanzarikiller)
- Luce a 3 intensità selezionabili
- Presa Micro-USB



UNIVERSAL PLUG 10A

Art. 7203341N

€ 4,90

12V - 10A

Spina universale 12V. Completa di fusibile di sicurezza integrato.

UNIVERSAL PLUG 15A

Art. 7203342N

€ 4,90

12V - 15A



PROLONGER 12V

Art. 0722083N

€ 11,50

12V

Cavo di prolunga con spina universale 12V. Fusibile da 10A. Lunghezza cavo: 3 m



SPIRAL PROLONGER 12V

Art. 0722084N

€ 11,50

12V

Cavo di prolunga a spirale con spina universale 12V. Fusibile da 5A. Lunghezza cavo: 2 m



TWIN CONNECT

Art. 7203356N

€ 12,90

12V

Connettore doppio 12V con due prese per spine accendisigari. Fusibile da 10A.



TWIN CONTROL

Art. 7203357N

€ 16,90

12V

Connettore doppio 12V con controllo batteria. Fusibile da 10A.



B-SWITCH 12V

Art. 7203307C

€ 21,90

12V

PACK 1X

Staccabatteria 12V/24V per veicoli ricreazionali ed autovetture. Resistenza fino a 500 A. Chiave estraibile.



B-OFF 12V

Art. 7203312C

€ 25,50

12V

PACK 1X

Staccabatteria 12V monopolo per veicoli ricreazionali ed autovetture.



PLUG 13 P

Art. 7203545C

€ 12,50

PACK 1X

Pres a 13 poli. Contatti nickel.



RECEPTACLE 13 P

Art. 7203591C

€ 12,50

PACK 1X

Pres a 13 poli. Con distacco automatico per luce antinebbia.



CAPTOR 13/7

Art. 7203593C

€ 9,90

PACK 1X

Adattatore da presa 13 poli (veicolo) a presa 7 poli (rimorchio).



CAPTOR 7/13

Art. 7203595C

€ 9,50

PACK 1X

Adattatore da presa 7 poli (veicolo) a presa 13 poli (rimorchio).

PROLONGER



PROLONGER CEE/CEE RUBBER

Cavo di prolunga CEE/CEE. Guaina in gomma. 230V-16A.



Art. 0301091C	10 m	€ 54,90
Art. 0301092C	25 m	€ 101,50
Art. 0301095N	50 m	€ 178,50



Art. 0301122C	5 m	€ 42,50
Art. 0301093C	10 m	€ 69,50
Art. 0301096C	15 m	€ 89,90
Art. 0301094C	25 m	€ 137,90



PROLONGER SCHUKO/SCHUKO

Cavo di prolunga Schuko/Schuko. Guaina in gomma. 230V-16A.



Art. 0301111C	10 m	€ 48,50
Art. 0301112C	25 m	€ 91,90



Art. 0301123C	5 m	€ 35,90
Art. 0301108C	10 m	€ 59,90
Art. 0301109C	25 m	€ 126,50



PROLONGER CEE/SCHUKO RUBBER

Cavo di prolunga CEE/Schuko. Guaina in gomma. 230V-16A.



Art. 0301126C	5 m	€ 32,50
Art. 0301127C	10 m	€ 50,90
Art. 0301128C	15 m	€ 67,50
Art. 0301115C	25 m	€ 92,50



Art. 0301116C	25 m	€ 134,90
---------------	------	----------



DRUMMER RUBBER 3X1,5

Art. 0301068N

€ 119,90

25 m / 3x1,5 mm²

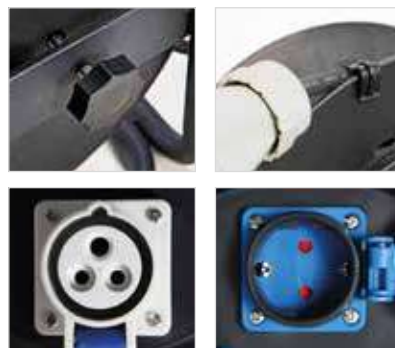

DRUMMER RUBBER 3X2,5

Art. 0301081N

€ 129,90

25 m / 3x2,5 mm²



Avvolgicavo CEE (guaina in gomma) dotato di 2 prese Schuko /1 presa CEE con coperchio e protezione da sovraccarico.



WHEELA

Art. 0301079N € 23,50

Ø35,5 x 10,5 cm



Avvolgicavo di alta qualità realizzato in robusto polipropilene. Leggero e funzionale, adatto a tutti i cavi elettrici con una lunghezza fino a 25 metri. Utilizzo semplice ed intuitivo, ideale per caravan, camper e motorhome.



ADAPTOR



ADAPTOR CEE/SCHUKO • 30 CM

Art. 0301076C € 9,90

PACK 1X

30 cm / 3x1,5 mm²



Art. 0301090C

€ 13,50

PACK 1X

30 cm / 3x2,5 mm²



Adattatore CEE/Schuko per esterni. Omologato CE 230V-16A. Cavo in gomma.



ADAPTOR SCHUKO/CEE 90 • 30 CM

Art. 0301082C € 14,50

PACK 1X

30 cm / 3x2,5 mm²



Adattatore Schuko/CEE. Omologato CE 230V-16A. Cavo in gomma.



ADAPTOR CEE/CEE 90 • 150 CM

Art. 0301084C € 25,50

PACK 1X

150 cm / 3x2,5 mm²



Adattatore CEE/CEE a gomito per esterni. Omologato CE 230V-16A. Cavo in gomma.



ADAPTOR CEE/SCHUKO 150 CM

Art. 0301070C € 17,50

PACK 1X

150 cm / 3x1,5 mm²



Art. 0301088C

€ 20,50

PACK 1X

150 cm / 3x2,5 mm²



Adattatore CEE/Schuko per esterni. Omologato CE 230V-16A. Cavo in gomma.



ADAPTOR SCHUKO/CEE 150 CM

Art. 0301071C € 17,50

PACK 1X

150 cm / 3x1,5 mm²



Art. 0301086C

€ 20,50

PACK 1X

150 cm / 3x2,5 mm²



Adattatore Schuko/CEE per esterni. Omologato CE 230V-16A. Cavo in gomma.



ADAPTOR SCHUKO/CEE 90 • 150 CM

Art. 0301073C € 19,50

PACK 1X

150 cm / 3x1,5 mm²



Art. 0301085C

€ 22,50

PACK 1X

150 cm / 3x2,5 mm²



Adattatore Schuko/CEE a gomito per esterni. Omologato CE 230V-16A. Cavo in gomma.



ADAPTOR CEE/SCHUKO

Art. 7203318C

€ 15,90

PACK 1X

Adattatore CEE/Schuko con presa bipasso. Omologato CE per uso temporaneo.

PLUG CEE 90

Art. 7203452C

€ 13,50

PACK 1X

Presa a gomito CEE con coperchio. Tre poli. Con presa Schuko posteriore.



COUPLER CEE 16A-230V

Art. 7203538C

€ 9,90

PACK 1X

Presa volante CEE 16A-230V.

PLUG CEE 16A-230V

Art. 7203540C

€ 8,90

PACK 1X

Spina volante CEE 16A-230V.



ELECTRO SAFE



ELECTRO SAFE

Art. 7203438N

€ 7,50

Ø 87 x 210 mm

Contenitore di protezione antispruzzo in materiale plastico per raccordi Schuko.

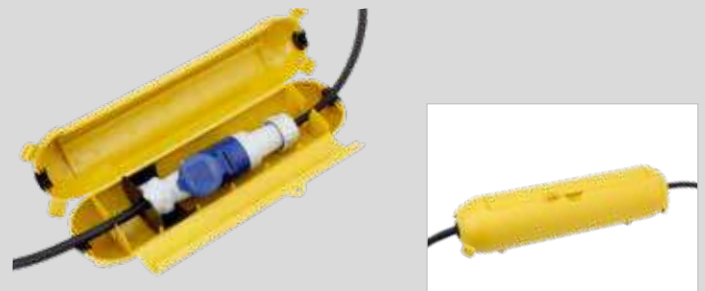

ELECTRO SAFE CEE

Art. 7203437N

€ 12,50

Ø 94 x 375 mm

Contenitore di protezione antispruzzo in materiale plastico per raccordi CEE.



WATER AND SANITATION



**GHIRBE
DOCCE
ACCESSORI VR
PRODOTTI CHIMICI**

WEDOR



Standard
DIN 96

WEDOR CHH 22

Art. 0810055N

€ 108,90

 32 x 27 x 53/87 cm

 3,7 kg

- Serbatoio mobile per acque grigie 22l.
- Realizzato in resistente materiale plastico HDPE
 - Compatto e leggero
 - Maniglia di trasporto pieghevole
 - Con indicatore di livello e manicotto di scarico
 - Grandi ruote facilitano il trasporto
 - Completo di scarico e coperchi a vite

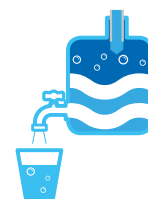

WEDOR CHH 40

Art. 0810057N

€ 139,90

 37,5 x 23 x 80 cm

 40 l

- Serbatoio mobile per acqua potabile 40l.
- Realizzato in resistente materiale plastico HDPE
 - Compatto e leggero
 - Maniglia di trasporto integrata
 - Grandi ruote facilitano il trasporto
 - Completo di tubo di scarico e coperchi a vite



FUNNEL

Art. 0810032N

€ 7,90

 Ø 14 x 40 cm

Imbuto in plastica con filtro integrato. Con trasvasatore flessibile.



MANTIX

Art. 0810042N

€ 25,50

✓ 9,4l



Ghirba a mannice in robusta plastica alimentare.



CUBE 10

Art. 0810021N

€ 8,50

✓ 10l

CUBE 15

Art. 0810022N

€ 9,50

✓ 15l

Ghirba pieghevole in robusta plastica alimentare. Con foro per appenderla e rubinetto regolabile ON/OFF.



WABOX 10

Art. 0810005N

€ 13,50

✓ 10l

WABOX 15

Art. 0810006N

€ 14,90

✓ 15l

Ghirba pieghevole in morbido materiale plastico alimentare.



ALEA 8

Art. 0810070N

€ 23,50

✓ 8l

ALEA 16

Art. 0810071N

€ 23,90

✓ 16l

Ghirba a fisarmonica in plastica alimentare.

FOLDAWAY



HEAT RESISTANT
40°C



BLUE PEARL

Art. 0810010N

€ 16,90

✓ 5,1l

Ø 19 x 11/25,6 cm

Contenitore d'acqua pieghevole in materiale plastico di alta qualità.

JERRY



JERRY PLUS

Ghirba in robusta plastica alimentare. Con foro per appenderla e rubinetto regolabile ON/OFF.

JERRY PRO

Taniche acqua portatili per Outdoor e camping. Caratterizzate da un grande tappo a vite e da un rubinetto ON/OFF. Realizzate in robusto polietilene alimentare.



JERRY PLUS 10	Art. 0810063N	10l	€ 18,50
JERRY PLUS 20	Art. 0810064N	20l	€ 20,50
JERRY PRO 15	Art. 0810073N	15l	€ 28,90
JERRY PRO 20	Art. 0810074N	20l	€ 33,50

AQUATIC



EASY
INSTALLATION



AQUATIC 10L

Art. 7202415C

€ 22,50

100 x Ø 38 mm

140 g

12V DC

l/min 10 l/min

PACK 1X

Pompa acqua ad immersione. Pressione: 0,6 bar. Completa di 90 cm di cavo elettrico di collegamento.

AQUATIC 18L

Art. 7202418C

€ 41,50

110 x Ø 64 mm

260 g

12V DC

l/min 18 l/min

PACK 1X

Pompa acqua ad immersione con dispositivo di sfiato automatico. Pressione: 1,0 bar. Completa di 90 cm di cavo elettrico di collegamento.

AQUATIC 22L

Art. 7202419N

€ 57,90

53 x 77 x 130 mm

290 g

12V DC

l/min 22 l/min

Potente pompa ad immersione con valvola di non ritorno e sfiato automatico. Involucro in ABS. Uso universale per bagno e cucina. Pressione: 1,4 bar. Cavo di collegamento da 100 cm.



FONTAY

Art. 7202413N C00

€ 29,90

125 g

12V - 3A

COLOR

C00 C37

Rubinetto ad erogazione automatica. Con interruttore microswitch 12V-3A. Pressione massima: 2,5 bar. Foro di montaggio: Ø 19 mm



PHTHALATE free

SOLAR PHF

Art. 0810018N

€ 12,50



20 l



SPLASH

Art. 0810023N

€ 63,50



15 l



Doccia solare in PVC atossico con flusso acqua regolabile e maniglia per appenderla.

Doccia a pressione. Con pompa a pedale e sacchetto custodia.



AQUAFRESH 2.0

Art. 0810013N

€ 37,90



2 kg



12V DC - 35W

l/min 3,5 l/min.

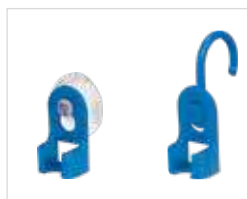

FLUX RG

Art. 0810014N

€ 59,50



620 g



2200mAh Li-Ion RG

l/min 4 l/min

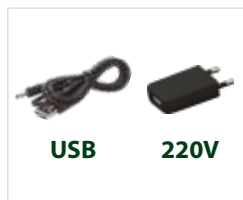

USB

220V

RECHARGEABLE



Doccia da viaggio a 12V per taniche d'acqua. Design moderno abbinato a prestazioni migliorate. Ideale per fare la doccia, per pulire il veicolo e/o la bicicletta o per risciacquare i piatti dopo i pasti. Design robusto e compatto. La fornitura contiene: doccetta con tubo flessibile 2m, pompa ad immersione 12V, ventosa per soffione doccia, cavo di collegamento (5m) con spina accendisigari 12V, borsa custodia.

Doccia Outdoor ricaricabile con interruttore ON/OFF. Leggera e senza fili. Ideale per camping, spiaggia, caravaning ed altre attività Outdoor.

CARATTERISTICHE:

- Funzionamento One-Touch
- Ricarica batterie mediante cavo USB
- Funzionamento con batteria al litio integrata



NEW
2023



OPTIPOT

Art. 0402028N

€ 29,90

31 x 31 x H37 cm

1,0 kg

23,5 l

WC portatile a secchio con tavoletta, coperchio e maniglia per il trasporto. Costruzione robusta e stabile in materiale plastico. Compatto e facile da trasportare rappresenta una soluzione pratica e conveniente in ambito outdoor e camping.



OPTITOIL

Art. 0402023N

€ 64,50

40 x 48 x H33 cm

2,4 kg

7 l

Moderna toilette portatile con seduta, coperchio e secchio chiudibile separatamente.



360°



OPTILOO

Art. 0402030N

€ 78,50

39 x 41,5 x H43 cm

2,4 kg

7 l

Moderno WC portatile con comoda altezza di seduta.

CARATTERISTICHE:

- Sedile e coperchio possono essere aperti e chiusi separatamente
- Secchio estraibile con coperchio
- Supporto per carta igienica
- Costruzione robusta fatta in resistente PP
- Design moderno

OPTIBAG

Art. 0402037N

€ 9,90

PACK 25X



BIO- DEGRADABLE

Sacchetti in plastica biodegradabile e compostabile per WC portatili.

WC-MASK

Art. 0402031N

€ 5,90

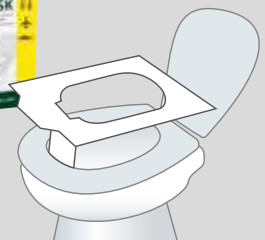

**BIO- DEGRADABLE
DISSOLVABLE IN WATER**



Coprisedile igienico per WC in carta dissolvente. Confezione da 20 pezzi.

BRUNER



ROLL ON 2.0

Art. 7203132N

€ 60,90

Ø 40 x H48 cm + tube 15 m

Avvolgitubo di nuova concezione con tubo piatto flessibile, resistente alla torsione e ad uso alimentare (costruzione a 3 camere), che in fase di utilizzo può essere srotolato solo fino alla lunghezza necessaria. Gli attacchi rapidi e la lancia sono inclusi nella fornitura.



AQUAFIL PRO

Art. 7203133N

€ 55,50

28 x 15 x H30 cm + tube 11,6 m

3/4"

Nuovo avvolgitubo dalle dimensioni compatte ideale per riempire i serbatoi o il lavaggio del veicolo, ma anche utilissimo per irrigare piante e fiori durante il soggiorno in campeggio. Involucro in resistente materiale plastico con maniglione integrato.

La fornitura comprende:

- 11,6 m di tubo flessibile alimentare Ø 7,9 mm (10 m interni + 1,6 m esterni di collegamento)
- lancia ergonomica a portata variabile "3 JET"



FELIX

Art. 7203135N

€ 27,90

tube 9 m

Tubo rifornimento acqua piatto, con guaina resistente a strappi e lacerazioni. Completo di raccordi.



HELIX

Art. 7203134N

€ 51,50

40 x 34 cm + tube 15 m

Avvolgitubo con tubo piatto dotato di guaina in tessuto antimangiatura. Completo di raccordi e lancia per doccia a quattro posizioni.



AQUAFIL

Art. 7203138N

€ 29,90

27,5 x 15,5 x 13,5 cm + tube 10 m

3/8"

Avvolgitubo portatile con tubo in PVC alimentare da 3/8" e 2 raccordi rapidi. Struttura in resistente materiale plastico. Completo di lancia. Lunghezza tubo: 10 m.

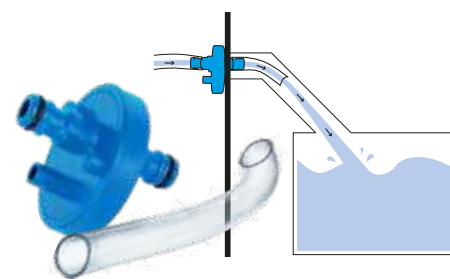

HYDOCK 67

Art. 7203140N € 11,90

Ø 67mm (2-pin)

Tappo di riempimento del serbatoio dell'acqua potabile con pratico attacco rapido. Connessione semplice e intuitiva tramite attacco a baionetta con diametro di 67 mm (2 pin) o 77 mm (3 pin). Realizzato in resistente plastica alimentare. Assicura il riempimento igienico e sicuro del serbatoio dell'acqua potabile.

HYDOCK 77

Art. 7203145N € 11,90

Ø 77mm (3-pin)

HYNECT

HYNECT S

Art. 7203144C € 9,90

3/4"



Manicotto per raccordare tubi di gomma alle canneli lisce.



HYNECT T

Art. 7203141C € 9,90

1/2"



**BEST
SELLER**



FLIZ

Art. 7203153N

€ 21,90

∕ 105 - 175 cm

📦 720 g

Idrospazzola con manico telescopico in alluminio, manopole in espanso e spazzola filettata con setole delicate. Larghezza spazzola 25 cm. Con attacco rapido.



MOPPY

Art. 7203156N

€ 27,90

∕ 115 - 180 cm

📦 780 g

Spazzola telescopica per lavaggio veicoli con manico in alluminio e raccordo rapido.



METAL



EXTRA STRONG

WOSH

Art. 7203150N

€ 43,90

∕ 140 - 240 cm

📦 1,46 kg

Spazzola di lavaggio telescopica a connessione rapida e con interruttore ON/OFF.



POPY

Art. 0402042N

€ 20,50

∕ Ø 9 x 32 cm

Spazzolino per WC in materiale plastico.



TOBY

Art. 0402046N

€ 13,50

∕ 8 x 25,5 cm

Spazzolino WC di dimensioni molto compatte. Montaggio a parete.



Silicon

TOBY SK

Art. 0402044N

€ 14,90

∕ 8 x 25,5 cm

Spazzolino WC di dimensioni molto compatte con setole in silicone.



TENT

CARE & MAINTENANCE



NYLON/ POLYESTER

Art. 0205014N

€ 19,90
39,80 €/l

✓ 500 ml

Impermeabilizzante per tessuti in nylon o poliestere. Azione idrorepellente, anti-deterioramento ed antimuffa.



SYNTHETIC

Art. 0205015N

€ 19,90
39,80 €/l

✓ 500 ml

Impermeabilizzante per tessuti sintetici pesanti (verande-teloni, ecc.). Azione idrorepellente, antideterioramento ed antimuffa.



COTTON

Art. 0205016N

€ 19,90
39,80 €/l

✓ 500 ml

Impermeabilizzante per tessuti naturali. Azione idrorepellente, antideterioramento ed antimuffa.



CLEANER

Art. 0205026N

€ 17,50
35,00 €/l

✓ 500 ml

Detergente per tessuti naturali e sintetici. Rimuove lo sporco senza indebolire tessuto e fibre.



SEALER

Art. 0202099N

€ 13,50
135,00 €/l

✓ 100 ml

Sigillante per cuciture su tessuti naturali e sintetici. Trasparente, elastico e lavabile.



ACTI-GUM

Art. 0205044N

€ 13,50
135,00 €/l

✓ 100 ml

Gel lubrificante silconico per fessure, profili, guarnizioni, cerniere, pali tenda, ecc.



ACTI-MAT REPAIR

Art. 0205027N

€ 12,50
125,00 €/l

✓ 100 ml

Liquido riparatore sigillante per prodotti in PVC oppure neoprene come materassini, canotti, piccoli gommoni ed articoli gonfiabili in genere. Inodore, non contiene solventi.



CAMPER/CARAVAN

CARE & MAINTENANCE



ACTI-FRESH

Art. 0205031N

€ 22,90

V 1000 ml

Liquido antifermentativo e deodorante per la rimozione/prevenzione di incrostazioni maleodoranti dai serbatoi di raccolta delle acque grigie.



ACTI-TANK

Art. 0205033N

€ 25,50

V 1000 ml

Liquido disincrostante per la rimozione di incrostazioni inorganiche (calcare) ed organiche (alghie, batteri) da serbatoi e condutture.



ACRYGLASS

Art. 0205012N

€ 13,90
27,80 €/l

V 500 ml

Detergente speciale per vetri acrilici. Rimuove insetti, nicotina, grasso, fuliggine, ecc. senza danneggiare il vetro.



ACTI-WASH

Art. 0205030N

€ 13,50
27,00 €/l

V 500 ml

Detergente superconcentrato per il lavaggio manuale della carrozzeria di camper, caravan ed autoveicoli.



ACTI-CLEAN

Art. 0205045N

€ 20,50
41,00 €/l

V 500 ml

Detergente specifico per la rimozione da superfici in metallo e plastica di forti contaminazioni.



TECHNIQUE

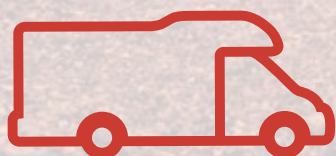

**COPERTURA E PROTEZIONI
ACCESSORI VR**

FLYNET MIDI



Zanzariera aggiuntiva con telaio in alluminio per il Dometic Midi Heki con funzionamento a manovella.

Impedite la penetrazione di sporcizia ed insetti fastidiosi con la nuova zanzariera FLYNET di nuova concezione. Con FLYNET la protezione del vostro veicolo inizia già a livello del tetto ed il fastidioso deposito di mosche, zanzare e altri parassiti, ma anche di foglie, aghi di alberi, ecc. sulla zanzariera interna e sulla tendina oscurante viene completamente eliminato.

FLYNET utilizza un telaio in alluminio di alta qualità. Ciò consente un fissaggio rapido, semplice e permanente al Dometic Midi Heki (con manovella) senza la necessità di fastidiose forature e/o avvitiamenti. Il telaio dell'obló Heki rimane completamente integro ed è visivamente migliorato. Se si desidera rimuovere la FLYNET per la pulizia o durante la pausa invernale, è sufficiente sollevarla ed estrarla.

CARATTERISTICHE:

- Telaio in alluminio di peso ridotto ed elevata stabilità
- Zanzariera in tessuto di fibra di vetro resistente alle intemperie
- Aspetto di alto livello grazie al moderno profilo in alluminio con bordi arrotondati e spazzole laterali
- Montaggio senza forare e/o avvitare
- Pronta per l'uso
- Adatta per il Midi-Heki originale Dometic con funzionamento a manovella
- Prodotta in UE

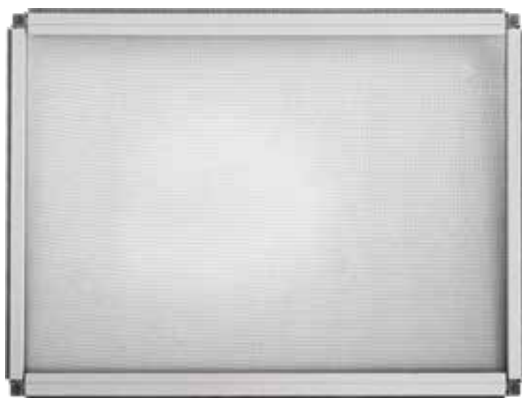

FLYNET MIDI

Art. 7232148N

€ 54,90

62,5 x 46 x H1,4 cm

600g





CAMPER COVER SI

SEMI-INTEGRATED MOTORHOMES

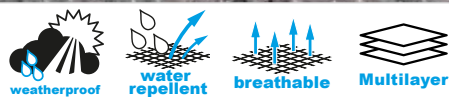

CAMPER COVER SI 6M

Copertura protettiva per camper semi-integrali.

CARATTERISTICHE:

- Tessuto traspirante e idrorepellente
- Tessuto non tessuto a 4 strati
- Sviluppato per l'uso invernale



Art.	Dimensione	Prezzo
Art. 7241507N	600 - 650	€ 289,90
Art. 7241508N	650 - 700	€ 299,90
Art. 7241509N	700 - 750	€ 312,50
Art. 7241510N	750 - 800	€ 322,90

Art.	7241507N	7241508N	7241509N	7241510N
cover size in cm	650x240x250	700x240x250	750x240x250	800x240x250
Size A cm	650	700	750	800
Size B cm	240	240	240	240
Size C cm	250	250	250	250

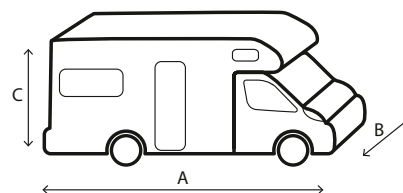

STAND-OFF SET

Art. 7110120N

€ 18,50



12 x 11,8 x 7,4 cm

22 g

PACK 4X

CORNER GUARD SET

Art. 7110121N

€ 40,50



27,4 x 17,6 x 6,9 cm

44 g

PACK 4X

Distanziatori per coperture di protezione in materiale schiumato EPP. Utilissimi per proteggere le parti esterne e le finestre del veicolo da sfregamenti ed abrasioni. Set 4 pezzi.

Protezioni angolari in resistente materiale schiumato EPP. Utilissime per bloccare le cinghie di tensionamento ed evitarne il contatto con i bordi inferiori del veicolo. Set 4 pezzi.

CAMPER COVER

ALCOVE MOTORHOMES



weatherproof



water repellent



breathable



Multilayer

CAMPER COVER 6M

WINTER PROTECTION 

Copertura protettiva per camper. Versione più larga e più alta. Tessuto TNT traspirante. Resistente ai raggi UV, idrorepellente e lavabile. Viene fornita in una comoda sacca custodia.



Art.	Dimensione	Prezzo
Art. 7241482N	500 - 550	€ 279,90
Art. 7241484N	550 - 600	€ 289,90
Art. 7241485N	600 - 650	€ 299,90
Art. 7241486N	650 - 700	€ 309,90
Art. 7241487N	700 - 750	€ 319,90
Art. 7241488N	750 - 800	€ 329,90
Art. 7241489N	800 - 850	€ 345,90

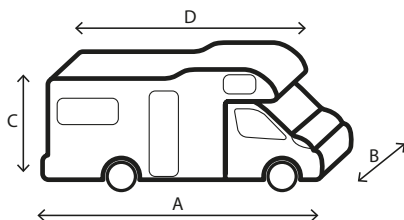

Art.	7241482N	7241484N	7241485N	7241486N	7241487N	7241488N	7241489N
cover size in cm	550x240x270	600x240x270	650x240x270	700x240x270	750x240x270	800x240x270	850x240x270
Size A cm	550	600	650	700	750	800	850
Size B cm	240	240	240	240	240	240	240
Size C cm	270	270	270	270	270	270	270
Size D cm	495	545	595	645	695	745	795



INFO

WINTER PROTECTION 

I materiali utilizzati per il tetto:

Tessuto non tessuto simile alla carta realizzato con microfilamenti di polietilene ad alta densità (PE-HD). Ideale per coperture all'aperto.

- Ottima resistenza chimica
- Resistente all'abrasione
- Traspirante
- Idrorepellente
- Permeabile al vapore acqueo
- Antivento

- Antistatico
- Non brucia, fonde a 135°C
- Flessibile anche con temperature < 0°C
- Precisione dimensionale
- Resistente agli strappi
- Range di temperatura: -75°C - + 80°C



CARAVAN COVER

WINTER PROTECTION

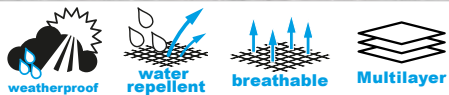

CARAVAN COVER 6M

Copertura protettiva per caravan. Tessuto TNT traspirante. Resistente ai raggi UV, idrorepellente e lavabile. Viene fornita in una comoda sacca custodia.



Art. 7241460N	400 - 450	€ 219,90
Art. 7241461N	450 - 500	€ 229,90
Art. 7241462N	500 - 550	€ 245,90
Art. 7241463N	550 - 600	€ 254,90
Art. 7241464N	600 - 650	€ 264,90
Art. 7241465N	650 - 700	€ 274,90
Art. 7241466N	700 - 750	€ 284,90
Art. 7241467N	750 - 800	€ 299,90

Art.	7241460N	7241461N	7241462N	7241463N	7241464N	7241465N	7241466N	7241467N
cover size in cm	450x240x220	500x240x220	550x250x220	600x250x220	650x250x220	700x250x220	750x250x220	800x250x220
Size A cm	450	500	550	600	650	700	750	800
Size B cm	240	240	250	250	250	250	250	250
Size C cm	220	220	220	220	220	220	220	220
Size D cm	405	455	505	555	605	655	705	755

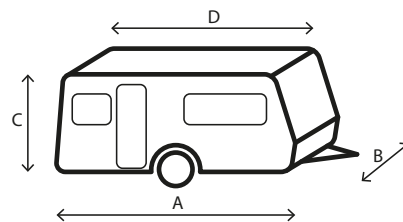

TOP COVER

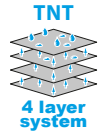

Funzionale copertura per tetti caravan. Realizzata in TNT a 4 strati traspirante ma idrorepellente. Dotato di pratica sacca custodia.

Art. 7241470N	400 - 450 x 390 cm	€ 164,90
Art. 7241471N	450 - 500 x 390 cm	€ 174,90
Art. 7241472N	500 - 550 x 390 cm	€ 184,90
Art. 7241473N	550 - 600 x 390 cm	€ 194,90
Art. 7241474N	600 - 650 x 390 cm	€ 204,90
Art. 7241475N	650 - 700 x 390 cm	€ 214,90
Art. 7241476N	700 - 750 x 390 cm	€ 224,90
Art. 7241477N	750 - 800 x 390 cm	€ 234,90

PRO COVER

12M DUCATO

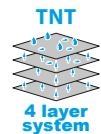

Copertura di protezione 12M a 4 strati realizzata appositamente per camper Ducato. Realizzata con materiali e finiture di ottima qualità che garantiscono un'efficace protezione del mezzo durante tutto l'anno. Disponibile in 3 misure.

Art. 7241457N	541 x 205 x H252 cm	€ 339,90
Art. 7241458N	599 x 205 x H277 cm	€ 349,90
Art. 7241459N	636 x 205 x H277 cm	€ 359,90



CAMPER COVER DESIGN

SUMMER / WINTER PROTECTION

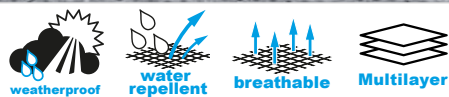

SUMMER / WINTER PROTECTION 



CAMPER COVER DESIGN 12M



Art.	Size	Price
Art. 7241540N	500 - 550 cm	€ 329,90
Art. 7241541N	550 - 600 cm	€ 339,90
Art. 7241542N	600 - 650 cm	€ 349,90
Art. 7241543N	650 - 700 cm	€ 364,90
Art. 7241544N	700 - 750 cm	€ 374,90
Art. 7241545N	750 - 800 cm	€ 389,90
Art. 7241546N	800 - 850 cm	€ 409,90

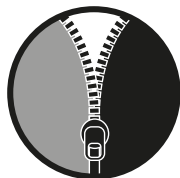

EQUIPPED WITH REAR ZIPS

Art.	7241540N	7241541N	7241542N	7241543N	7241544N	7241545N	7241546N
cover size in cm	550x240x270	600x240x270	650x240x270	700x240x270	750x240x270	800x240x270	850x240x270
Size A cm	550	600	650	700	750	800	850
Size B cm	240	240	240	240	240	240	240
Size C cm	270	270	270	270	270	270	270
Size D cm	495	545	595	645	695	745	795

Le coperture per camper della linea Design 12M fanno tesoro della nostra continua ricerca di soluzioni all'avanguardia e consolidano 5 anni di esperienza nella produzione unendola ad un nuovo design moderno e accattivante che si ispira alla veste grafica attualmente riscontrabile su molti veicoli ricreazionali.

CARATTERISTICHE:

- Tessuto in TNT antigraffio e traspirante a 4 strati resistente ai raggi UV
- Ottima protezione del mezzo da fattori esterni quali pioggia, sole, polvere, inquinamento chimico, escrementi animali, foglie, ecc
- Ottimo sistema di fissaggio antivento mediante robuste cinghie dotate di fibbia tensionatrice
- Dotate di cerniere laterali che permettono un comodo accesso al mezzo quando coperto
- Dotate di cerniere posteriori che facilitano notevolmente le operazioni di copertura e permettono l'accesso alla parte posteriore del mezzo quando coperto
- Complete di sacca custodia
- Colore: grigio chiaro/grigio scuro

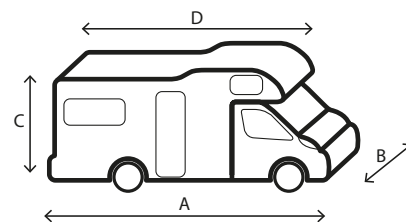

CARAVAN COVER DESIGN

SUMMER / WINTER PROTECTION

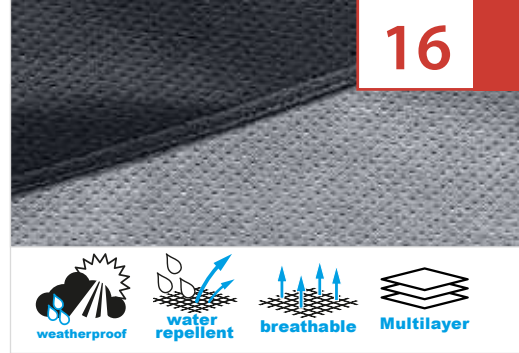

CARAVAN COVER DESIGN 12M



Art. 7241550N	400 - 450 cm	€ 269,90
Art. 7241551N	450 - 500 cm	€ 279,90
Art. 7241552N	500 - 550 cm	€ 289,90
Art. 7241553N	550 - 600 cm	€ 299,90
Art. 7241554N	600 - 650 cm	€ 309,90
Art. 7241555N	650 - 700 cm	€ 319,90
Art. 7241556N	700 - 750 cm	€ 339,90
Art. 7241557N	750 - 800 cm	€ 364,90



Art.	7241550N	7241551N	7241552N	7241553N	7241554N	7241555N	7241556N	7241557N
cover size in cm	450x240x220	500x240x220	550x250x220	600x250x220	650x250x220	700x250x220	750x250x220	800x250x220
Size A cm	450	500	550	600	650	700	750	800
Size B cm	240	240	250	250	250	250	250	250
Size C cm	220	220	220	220	220	220	220	220
Size D cm	405	455	505	555	605	655	705	755

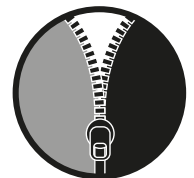

EQUIPPED WITH REAR ZIPS

Le coperture per caravan della linea Design 12M fanno tesoro della nostra continua ricerca di soluzioni all'avanguardia e consolidano 5 anni di esperienza nella produzione unendola ad un nuovo design moderno e accattivante che si ispira alla veste grafica attualmente riscontrabile su molti veicoli ricreazionali.

CARATTERISTICHE:

- Tessuto in TNT antigraffio e traspirante a 4 strati resistente ai raggi UV
- Ottima protezione del mezzo da fattori esterni quali pioggia, sole, polvere, inquinamento chimico, escrementi animali, foglie, ecc
- Ottimo sistema di fissaggio antivento mediante robuste cinghie dotate di fibbia tensionatrice
- Dotate di cerniere laterali che permettono un comodo accesso al mezzo quando coperto
- Dotate di cerniere posteriori che facilitano notevolmente le operazioni di copertura e permettono l'accesso alla parte posteriore del mezzo quando coperto
- Complete di sacca custodia
- Colore: grigio chiaro/grigio scuro

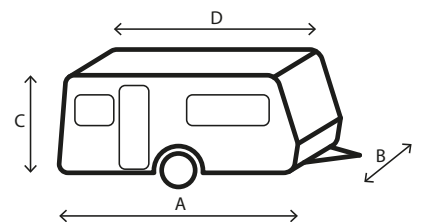



CLI-MATS XT



Oscuranti termici esterni per cabine guida.

Art. 7241331N	Fiat Ducato 1991-06/1994	€ 172,50
Art. 7241332N	Fiat Ducato 07/1994-06/2002	€ 172,50
Art. 7241333N	Fiat Ducato 244 07/2002-06/2006	€ 172,50
Art. 7241351N	Fiat Ducato x250 07/2006-06/2014 Best Seller	€ 172,50
Art. 7241307N	Fiat Ducato x290 07/2014-->	€ 172,50
Art. 7241367N	Fiat Talento 2017-->	€ 172,50
Art. 7241334N	Mercedes Benz Sprinter 07/2000-06/2006	€ 172,50
Art. 7241354N	Mercedes Benz Sprinter 07/2006-06/2014	€ 172,50
Art. 7241432N	Mercedes Benz Sprinter 07/2014-06/2018	€ 172,50
Art. 7241437N	Mercedes Benz Sprinter 07/2018-->	€ 172,50
Art. 7241335N	Ford Transit 2.6 07/2000-06/2006	€ 172,50
Art. 7241355N	Ford Transit 2.7 07/2006-06/2014	€ 172,50
Art. 7241309N	Ford Transit 2.8 07/2014-->	€ 172,50
Art. 7241318N	Ford Transit Custom 10/2012-11/2017	€ 172,50
Art. 7241276N	Ford Transit Custom 12/2017-->	€ 172,50
Art. 7241277N	Ford Transit Custom Rain Sensor 12/2017-->	€ 172,50
Art. 7241336N	VW T4 1990-05/2003	€ 172,50
Art. 7241346N	VW T5 06/2003-06/2014	€ 172,50
Art. 7241365N	VW T6 07/2014-->	€ 172,50
Art. 7241356N	VW Crafter 07/2006-06/2012	€ 172,50
Art. 7241358N	VW Crafter 07/2012-06/2017	€ 172,50
Art. 7241338N	Renault Trafic 2S+3S 07/2001-06/2014	€ 172,50
Art. 7241272N	Renault Trafic 07/2014-->	€ 172,50
Art. 7241337N	Renault Master 2S 1997-06/2003	€ 172,50
Art. 7241347N	Renault Master 3S 07/2003-06/2010	€ 172,50
Art. 7241364N	Renault Master 4S 07/2010-06/2014	€ 172,50
Art. 7241274N	Renault Master 5S 07/2014-->	€ 172,50
Art. 7241353N	Iveco Daily 4S 07/2006-06/2014	€ 172,50
Art. 7241273N	Iveco Daily 5S 07/2014-->	€ 172,50
Art. 7241384N	Citroen Campster 2017-->	€ 172,50

CARA MATS XT



Oscuranti termici esterni per finestre di caravan.



Art. 7241339N	110 x 75 cm	€ 53,90
Art. 7241340N	130 x 75 cm	€ 57,50
Art. 7241341N	140 x 75 cm	€ 64,50
Art. 7241342N	160 x 75 cm	€ 69,50
Art. 7241343N	170 x 75 cm	€ 79,90
Art. 7241344N	180 x 80 cm	€ 87,50
Art. 7241345N	190 x 80 cm	€ 91,50



HEKI COVER PRO

Coperture di protezione concepite appositamente per tutti gli oblò della linea Heki. Costruite con materiale multistrato isolante, resistente alle intemperie ed alla grandine.

Art. 7145211N	Heki I	€ 62,50
Art. 7145212N	Heki II	€ 62,50
Art. 7145213N	Heki III e IV	€ 62,50
Art. 7145214N	Mini Heki	€ 38,50
Art. 7145215N	Midi Heki	€ 57,90
Art. 7145216N	Heki Universal	€ 59,90



CLI-MATS SPLIT

CLI-MATS SPLIT

Copertura integrale isolante per cabine guida di veicoli ricreazionali. Parabrezza e vano motore possono essere coperti, a seconda della stagione, contemporaneamente o separatamente. Ottima isolazione grazie allo speciale materiale multistrato. Con balza perimetrale.



Art. 7241405N	Fiat Ducato 1991-06/1994	€ 459,50	Art. 7241266N	Ford Transit Custom Rain Sensor 12/2017-->	€ 459,50
Art. 7241390N	Fiat Ducato 07/1994-06/2002	Best Seller € 345,50	Art. 7241407N	VW T4 1990-05/2003	€ 459,50
Art. 7241391N	Fiat Ducato 244 07/2002-06/2006	Best Seller € 345,90	Art. 7241396N	VW T5 06/2003-06/2014	€ 459,50
Art. 7241392N	Fiat Ducato x250 07/2006-06/2014	Best Seller € 344,90	Art. 7241265N	VW T6 07/2014-->	€ 459,50
Art. 7241387N	Fiat Ducato x290 07/2014-->	Best Seller € 345,50	Art. 7241264N	VW Crafter 07/2006-06/2012	€ 459,50
Art. 7241269N	Fiat Talento 2017-->	€ 459,50	Art. 7241260N	VW Crafter 07/2012-06/2017	€ 459,50
Art. 7241393N	Mercedes Benz Sprinter 07/2000-06/2006	€ 459,50	Art. 7241410N	Renault Trafic 2S+3S 07/2001-06/2014	€ 459,50
Art. 7241394N	Mercedes Benz Sprinter 07/2006-06/2014	€ 459,50	Art. 7241388N	Renault Trafic 07/2014-->	€ 459,50
Art. 7241408N	Mercedes Benz Sprinter 07/2014-06/2018	€ 459,50	Art. 7241402N	Renault Master 2S 1997-06/2003	€ 459,50
Art. 7241268N	Mercedes Benz Sprinter 07/2018-->	€ 459,50	Art. 7241389N	Renault Master 3S 07/2003-06/2010	€ 459,50
Art. 7241404N	Ford Transit 2.6 07/2000-06/2006	€ 459,50	Art. 7241398N	Renault Master 4S 07/2010-06/2014	€ 459,50
Art. 7241395N	Ford Transit 2.7 07/2006-06/2014	Best Seller € 359,50	Art. 7241406N	Renault Master 5S 07/2014-->	€ 459,50
Art. 7241386N	Ford Transit 2.8 07/2014-->	Best Seller € 357,90	Art. 7241401N	Iveco Daily 4S 07/2006-06/2014	€ 459,50
Art. 7241399N	Ford Transit Custom 10/2012-11/2017	€ 459,50	Art. 7241385N	Iveco Daily 5S 07/2014-->	€ 459,50
Art. 7241267N	Ford Transit Custom 12/2017-->	€ 459,50	Art. 7241400N	Citroen Campster 2017-->	€ 459,50





CLI-MATS NT

Set oscuranti termici composto da tre elementi realizzati in tessuto multistrato.

Art. 7241319N	Fiat Ducato 1991-06/1994	€ 83,50
Art. 7241320N	Fiat Ducato 07/1994-06/2002	€ 83,50
Art. 7241321N	Fiat Ducato 244 07/2002-06/2006	€ 83,50
Art. 7241314N	Fiat Ducato x250 07/2006-06/2014	Best Seller € 79,90
Art. 7241304N	Fiat Ducato x290 07/2014-->	Best Seller € 79,90
Art. 7241279N	Fiat Talento 2017-->	€ 83,50
Art. 7241322N	Mercedes Benz Sprinter 07/2000-06/2006	€ 83,50
Art. 7241313N	Mercedes Benz Sprinter 07/2006-06/2014	€ 83,50
Art. 7241315N	Mercedes Benz Sprinter 07/2014-06/2018	€ 83,50
Art. 7241278N	Mercedes Benz Sprinter 07/2018-->	€ 83,50
Art. 7241323N	Ford Transit 2.6 07/2000-06/2006	€ 83,50
Art. 7241312N	Ford Transit 2.7 07/2006-06/2014	€ 83,50
Art. 7241306N	Ford Transit 2.8 07/2014-->	€ 83,50
Art. 7241316N	Ford Transit Custom 10/2012-11/2017	€ 83,50
Art. 7241305N	Ford Transit Custom 12/2017-->	€ 83,50
Art. 7241310N	Ford Transit Custom Rain Sensor 12/2017-->	€ 83,50
Art. 7241324N	VW T4 1990-05/2003	€ 83,50
Art. 7241328N	VW T5 06/2003-06/2014	€ 83,50
Art. 7241292N	VW T6 07/2014-->	€ 83,50
Art. 7241311N	VW Crafter 07/2006-06/2012	€ 83,50
Art. 7241300N	VW Crafter 07/2012-06/2017	€ 83,50
Art. 7241325N	Renault Trafic 2S+3S 07/2001-06/2014	€ 83,50
Art. 7241293N	Renault Trafic 07/2014-->	€ 83,50
Art. 7241326N	Renault Master 2S 1997-06/2003	€ 83,50
Art. 7241329N	Renault Master 3S 07/2003-06/2010	€ 83,50
Art. 7241379N	Renault Master 4S 07/2010-06/2014	€ 83,50
Art. 7241285N	Renault Master 5S 07/2014-->	€ 83,50
Art. 7241352N	Iveco Daily 4S 07/2006-06/2014	€ 83,50
Art. 7241303N	Iveco Daily 5S 07/2014-->	€ 83,50
Art. 7241363N	Citroen Campster 2017-->	€ 83,50

CLI-MATS NT THERMO

IN

OUT

Set oscuranti termici composto da un grande oscurante per il parabrezza e due oscuranti per i finestrini laterali. Sacca custodia inclusa.

Art. 7241283N	Fiat Ducato x290 07/2014-->	€ 94,50
Art. 7241284N	Mercedes Benz Sprinter 07/2014-06/2018	€ 94,50
Art. 7241286N	Ford Transit 2.8 07/2014-->	€ 94,50
Art. 7241288N	VW T5 06/2003-06/2014	€ 94,50
Art. 7241287N	VW T6 07/2014-->	€ 94,50



CLI-MATS NT THERMO BLACK

IN

OUT

Specificamente sviluppato per l'uso invernale, questo set di oscuranti termici in 3 pezzi ha un alto effetto di isolamento termico contro il freddo. Perfettamente adatto anche come protezione della propria privacy. Facile e veloce da montare grazie a ventose dotate di un'eccellente aderenza. Esterno: Nero, in pellicola lavabile. Interno: Grigio, in pellicola lavabile. Con borsa custodia.

Art. 7241283N.C03	Fiat Ducato x290 07/2014-->	€ 103,90
Art. 7241288N.C03	VW T5 06/2003-06/2014	€ 103,90
Art. 7241287N.C03	VW T6 07/2014-->	€ 103,90



CLI-MATS NT ROLL

Art. 7241299N € /m 28,90

- Roll 50 m
- PE / PVC

Tessuto isolante a 7 strati per oscuranti Cli-Mats.



CLI-MATS ROLL

Art. 7241330N € /m 33,50

- Roll 30 m
- PE / PVC

Tessuto isolante pluristrato per oscuranti Cli-Mats e Cara-Mats.

CLI-MATS CAPS

Art. 7241327C



€ 4,90



PACK 3X

Kit ventose per oscuranti termici Cli-Mats.

A-COVER

Art. 7130209N

€ 18,50



100% PVC

Copritimone in foglio di PVC, con bordatura di rinforzo.

THERMOSTEER

Art. 7130213N

€ 21,90



Ø 48,5 cm

145 g

100% PE / PVC

Copertura per volante realizzata in materiale termoriflettente. Ideale per non scottarsi le mani e proteggere il volante da temperature troppo elevate. Montaggio rapidissimo. Adatto a tutte le misure di volante standard.

GASTANK COVER

Art. 7130214N

€ 40,90



PE / PVC

Protezione multistrato in materiale termoriflettente per bombole gas 11 kg.



WHEEL COVER

Protezioni copriruote per caravan e camper.



Art. 7130205N

For caravan tyres (13" - 15")

€ 22,50

Art. 7130208N

For motorhome tyres (16" - 18")

€ 21,90



APRON 50

Art. 7130215N

€/m 14,90

APRON 70

Art. 7130216N

€/m 19,50

Roll 50 m x H50 cm

100% PVC

Roll 50 m x H70 cm

100% PVC

Grembiule paravento per verande caravan. Realizzato in resistentissimo tessuto spalmato PVC su entrambi i lati.

APRON STORAGE

Art. 7130217N

€ 83,50

600 x 40 + 14 cm

Polyester Oxford PVC



ATTENZIONE: LA VENDITA DI QUESTO PRODOTTO NON E' CONSENTITA IN GERMANIA

Pratica protezione antivento dotata di grandi scomparti con cerniera. Unica lunghezza, adattabile alla misura desiderata.



CLIMATS ALLROUND VW



Set oscuranti termici Allround per VW.

Art. 7241434N	VW T4 2002-04	€ 247,50
Art. 7241422N	VW T5 OE 2004-10	€ 212,50
Art. 7241423N	VW T5 WOE Short Version 2004-->	€ 247,50
Art. 7241421N	VW T6	€ 247,50
Art. 7241433N	Multivan Starline 2004-->	€ 247,50
Art. 7241430N	Transporter 2004-->	€ 247,50
Art. 7241429N	California 2010-->	€ 247,50
Art. 7241435N	California Beach	€ 247,50

CLI-MATS NT VW



Set oscuranti termici composto da tre elementi realizzati in tessuto multistrato ad alta isolamento termica.

Art. 7241324N	VW T4 1990-05/2003	€ 83,50
Art. 7241328N	VW T5 06/2003-06/2014	€ 83,50
Art. 7241292N	VW T6 07/2014-->	€ 83,50

VOLKSWAGEN COLLECTION

T4 - T5 - T6



THERMOSKIN XT

Telo isolante Thermoskin per tetti rialzabili.

CARATTERISTICHE:

- Resistente all'acqua e ai raggi UV
- Impedisce perdita di calore in inverno e protegge dai calori estivi
- Protegge da umidità
- E' inclusa una sacca custodia



Art. 7130197N	VW T4	€ 329,90
Art. 7130199N	VW T5	€ 329,90
Art. 7130188N	VW T6	€ 329,90

THERMOSKIN NT

Telo isolante Thermoskin per tetti rialzabili di T4, T5 e T6. Protegge da acqua di condensa e spiacevole umidità. In dotazione anche una comoda sacca.

Art. 7130195N	VW T4	€ 423,50
Art. 7130196N	VW T5	€ 423,50
Art. 7130187N	VW T6	€ 423,50





VOLKSWAGEN

T4 - T5 - T6

COLLECTION



TAPIS DELUXE

Tappetino per cabina guida.



Art. 0201207N	VW T4 1990-05/2003	€ 56,50
Art. 0201208N	VW T5 06/2003-06/2014	€ 56,50
Art. 0201226N	VW T6 07/2014-->	€ 56,50

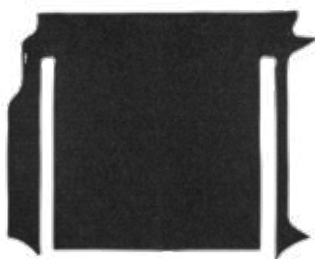

TAPIS CA

Tappeto zona passeggeri per Volkswagen T5 California Comfortline/Trendline.



Art. 0201230N	California Comfortline/Trendline 4P (2 alurails)	€ 134,50
Art. 0201231N	California Comfortline/Trendline 5P (alurails)	€ 134,50
Art. 0201232N	California Beach 2011 (4 rails)	€ 134,50



TAPIS BA

Resistente tappeto per bagagliaio per VW T5 e T6.



Art. 0201233N	VW T5 Short Version	€ 49,50
Art. 0201234N	VW T5 Long Version	€ 56,50
Art. 0201235N	VW T6 Short Version	€ 51,50
Art. 0201236N	VW T6 Long Version	€ 57,90



STEPPER MICRO

Tappetino di accesso per camper. Fissaggio tramite dispositivo a strappo compreso nella confezione.



Art. 0201187N	VW T5	€ 25,90
Art. 0201191N	VW T6	€ 25,90

CAMPSTER & CROSSCAMP

COLLECTION



CLI-MATS NT

Set oscuranti termici composto da tre elementi realizzati in tessuto multistrato.

Art. 7241363N Citroen Campster 2017-->

€ 83,50



TAPIS DELUXE

Tappetino per cabina guida.

Art. 0201199N Citroen Campster 2017-->

€ 56,50



CLIMATS ALLROUND

Set oscuranti termici Allround.

Art. 7241454N Citroen Campster

€ 225,90

Art. 7241455N Citroen Spacetourer

€ 247,50

Art. 7241438N Toyota Crosscamp

€ 247,50

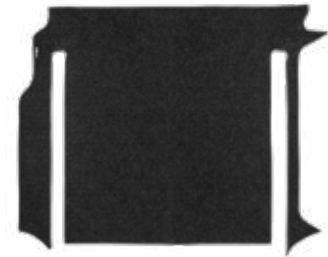

TAPIS CA

Tappeto zona passeggeri per Citroen Campster.

Art. 0201197N Citroen Campster 2017

€ 134,50



THERMOSKIN XT

Telo isolante Thermoskin per tetti rialzabili.



CARATTERISTICHE:

- Resistente all'acqua e ai raggi UV
- Impedisce perdita di calore in inverno e protegge dai calori estivi
- Protegge da umidità
- E' inclusa una sacca custodia

Art. 7130186N Citroen Campster

€ 329,90

Art. 7130185N Toyota Crosscamp

€ 449,90



TAPIS BA

Resistente tappeto per bagagliaio per Citroen Campster.

Art. 0201196N Citroen Campster 2017

€ 46,50



TAPIS DELUXE

Tappetino per cabina guida.



Art. 0201200N	Fiat Ducato 1991-06/1994	€ 56,50
Art. 0201201N	Fiat Ducato 07/1994-06/2002	€ 56,50
Art. 0201202N	Fiat Ducato 244 07/2002-06/2006	€ 56,50
Art. 0201215N	Fiat Ducato x250 07/2006-06/2014	€ 56,50
Art. 0201205N	Fiat Ducato x290 07/2014-06/2019	€ 56,50
Art. 0201192N	Fiat Ducato 07/2019-->	€ 56,50
Art. 0201216N	Mercedes Benz Sprinter 07/2000-06/2006	€ 56,50
Art. 0201204N	Mercedes Benz Sprinter 07/2006-06/2014	€ 56,50
Art. 0201195N	Mercedes Benz Sprinter 07/2014-06/2018	€ 56,50
Art. 0201193N	Mercedes Benz Sprinter 07/2018-->	€ 56,50
Art. 0201218N	Ford Transit 2.6 07/2000-06/2006	€ 56,50
Art. 0201219N	Ford Transit 2.7 07/2006-06/2014	€ 56,50
Art. 0201206N	Ford Transit 2.8 07/2014 --> / Ford Transit Custom 10/2012 --> / Ford Transit Custom Rain Sensor 12/2017 -->	€ 56,50
Art. 0201207N	VW T4 1990-05/2003	€ 56,50
Art. 0201208N	VW T5 06/2003-06/2014	€ 56,50
Art. 0201226N	VW T6 07/2014-->	€ 56,50
Art. 0201209N	VW Crafter 07/2006-06/2012	€ 56,50
Art. 0201227N	VW Crafter 07/2012-06/2017	€ 56,50
Art. 0201211N	Renault Trafic 2S+3S 07/2001-06/2014	€ 56,50
Art. 0201189N	Renault Trafic 07/2014-->	€ 56,50
Art. 0201212N	Renault Master 2S 1997-06/2003	€ 56,50
Art. 0201213N	Renault Master 3S 07/2003-06/2010	€ 56,50
Art. 0201222N	Renault Master 4S 07/2010-06/2014	€ 56,50
Art. 0201194N	Renault Master 5S 07/2014-->	€ 56,50
Art. 0201220N	Iveco Daily 4S 07/2006-06/2014	€ 56,50
Art. 0201224N	Iveco Daily 5S 07/2014-->	€ 56,50
Art. 0201199N	Citroen Campster 2017-->	€ 56,50



TAPIS DELUXE

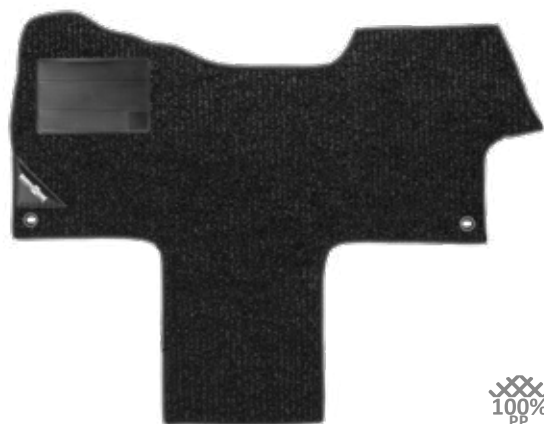

TAPIS DELUXE SECURITY

Tappeto per cabina guida con sistema di bloccaggio.

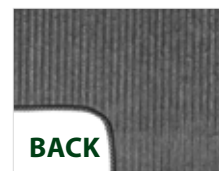
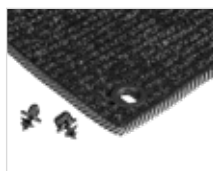

Art. 0201240N	Ducato 2006-14	€ 63,50
Art. 0201239N.C03	Ducato 07/2014-06/2019	€ 63,50
Art. 0201229N.C03	Ducato 07/2019-->	€ 65,50



TAPIS RUBBERMAT

Bellissimi tappetini per cabina guida a sagoma perfetta realizzati interamente in gomma inodore di prima qualità. Ideali per proteggere il veicolo da sporco ed umidità. Ottima aderenza al pavimento del veicolo che evita fastidiosi scivolamenti sotto ai pedali. Facili da posizionare/rimuovere e da pulire. Disponibili per tutti i modelli di veicoli più diffusi.

Art. 0201009N	Ducato/Citroen	€ 65,90
Art. 0201010N	Transit Custom Automatic	€ 61,50
Art. 0201011N	Transit Custom Manual	€ 61,50
Art. 0201013N	VW T6.1 Transporter/Multivan 01/2020-->	€ 69,50
Art. 0201014N	Transport VW T5 2004--> / VW T6 2015-12/2019	€ 69,50



RUNNER

Corsia per veicoli ricreazionali, con fondo antisdrucciolo.



Art. 0201003N.C06	45 x 45 cm	€ 10,50
Art. 0201001N.C06	80 x 45 cm	€ 25,50
Art. 0201004N.C06	150 x 45 cm	€ 32,90
Art. 0201002N.C06	200 x 45 cm	€ 43,50
Art. 0201006N.C06	250 x 45 cm	€ 49,90
Art. 0201007N.C06	300 x 45 cm	€ 59,50
Art. 0201008N.C06	350 x 45 cm	€ 69,90

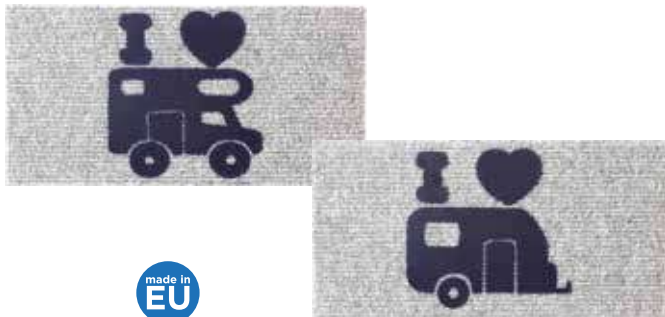

HELLO CAMPER

Art. 0201034N.CA

€ 12,90

HELLO CARAVAN

Art. 0201034N.CV

€ 12,90

25 x 50 cm

100% PP

25 x 50 cm

100% PP

Pratico zerbino con simpatici motivi legati al camper e alla caravan. Protegge gli interni del mezzo da terra, polvere e sporco. Dotato di rivestimento inferiore antisdrucciolo.



STEPPER MICRO

Tappetino di accesso per camper. Fissaggio tramite dispositivo a strappo compreso nella confezione.

Art. 0201180N	Ducato 2002-06	€ 25,90
Art. 0201166N	Ducato 2006-14	€ 25,90
Art. 0201188N	Ducato 2015-08/2019	€ 25,90
Art. 0201182N	Mercedes Sprinter 2006-->	€ 25,90
Art. 0201181N	Ford Transit 2006-->	€ 25,90
Art. 0201170N	Ducato 09/2019-->	€ 25,90



BIKE COVER

COLLECTION



BIKE COVER 2/3 - BIKE COVER 4



Art. 7130219N	BIKE COVER 2/3	€ 59,50
Art. 7130210N	BIKE COVER 4	€ 68,50
Art. 7130200N	BIKE COVER SPECIAL 2/3	€ 73,50
Art. 7130220N	E-BIKE COVER 2	€ 73,50
Art. 7130212N	BIKE COVER CVN 2	€ 61,50



Warning sign not included

Copribicicletta in resistente tessuto di poliestere con spalmatura idrorepellente. Dotato di speciale tasca per la sistemazione del cartello carichi sporgenti.



Reflector

BIKE COVER SPECIAL 2/3



E-BIKE COVER 2



BIKE COVER TOW BAR COLLECTION



Art. 7130201N	BIKE COVER TB 2	€ 61,90
Art. 7130203N	BIKE COVER TB 4	€ 69,90



Copribici di alta qualità per portabiciclette montati su gancio di traino. Realizzato in robusto tessuto di poliestere spalmato e impermeabile. La sicurezza è ulteriormente garantita da diverse cinghie di tensione che impediscono l'eccessivo sventolio del telo in caso di forte vento. Con tasca trasparente per cartello carichi sporgenti. Inclusa borsa custodia. Disponibile in 2 versioni, per 2 e 4 biciclette.



Warning sign not included



ZEBRA PL

Art. 7136010N

€ 11,50

50 x 50 cm

Cartello carichi sporgenti in materiale plastico con 4 retroriflettori. Non omologato in Italia!



ZEBRA ALU

Art. 7136012N

€ 45,90

50 x 50 cm

Cartello per carichi sporgenti in alluminio. Obbligatorio in Italia!

BIKE COVER CVN 2



BIKE HOOD NG

Art. 7130211N

€ 39,90

Telo protettivo per biciclette adatto anche per piccoli motorini.

220 x 65 x H140 cm
Polyester PU



BAG COLLECTION



LEVELER BAG

Art. 7241005N

57 x 20 x 15 cm

100% Oxford Polyester

Borsa per 2 cunei livellatori.

€ 15,50



PRO-BAG CABLE S

Art. 7241009N

Ø 36 x 10 cm

100% Oxford Polyester

Borsa custodia e di protezione per cavi prolunga.

€ 12,50



PRO-BAG MIRROR

Art. 7241016N

40 x 20 x 12 cm

100% Oxford Polyester

Borsa custodia e di protezione per specchi retrovisori supplementari.

€ 35,90



PRO-BAG POLES

Art. 7241015N

120 x 30 x 25cm

100% Oxford Polyester

Borsa custodia e di protezione per paleria tende.

€ 34,50





PRO-BAG CHAIR

Art. 7241012N

€ 36,50

 120 x 65 x 24 cm

 100% Oxford Polyester

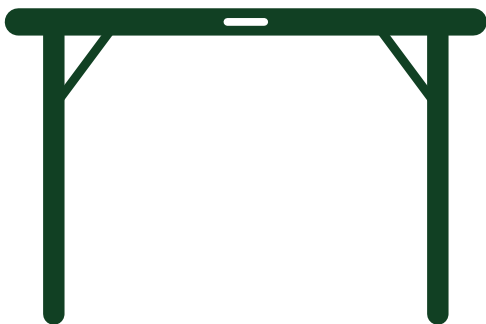

Borsa custodia e di protezione per sedie pieghevoli.



PRO-BAG TABLE



Borsa di protezione e trasporto per tavoli camping ed outdoor realizzata in resistente poliestere.

	PRO-BAG TABLE XS	Art. 7241006N	85 x 65 x 6 cm	100% Oxford Polyester	€ 31,50
	PRO-BAG TABLE S	Art. 7241010N	100 x 64 x 4 cm	100% Oxford Polyester	€ 28,50
	PRO-BAG TABLE M	Art. 7241007N	105 x 75 x 6 cm	100% Oxford Polyester	€ 33,90
	PRO-BAG TABLE L	Art. 7241011N	120 x 72 x 6 cm	100% Oxford Polyester	€ 30,50
	PRO-BAG TABLE XL	Art. 7241008N	125 x 80 x 7 cm	100% Oxford Polyester	€ 37,50



KING STEP



KING STEP

Art. 7225135N

€ 29,90

43 x 30 x H26/31 cm

2,25 kg

150 kg



COLORS



Gradino di entrata con stabile struttura in acciaio e superficie in gomma antiscivolo.



KING DOUBLE STEP

Art. 7225136N

€ 59,90

43 x 63 x H18/38/43 cm

4,1 kg

150 kg



COLORS



Gradino di entrata doppio con stabile struttura in acciaio e superficie in gomma antiscivolo.



KING DOUBLE STEP XL

Art. 7225137N

€ 89,90

55 x 62,5 x H18/38 cm

4,5 kg

150 kg



Elegante gradino doppio con ampia superficie antiscivolo. Sovrapponibile.



STEPPER FIX

Art. 0201165N.C34

€ 12,90

Tappeto coprigradino antiscivolo. Fissaggio semplice e rapido con cinghie nastro a contatto aperti e chiusi.



STEPPER MOVE

Art. 0201162N

€ 17,90

Tappeto coprigradino antiscivolo. Fissaggio mediante l'aggancio di 2 molle nei fori occhiellati. Adatto per gradini con larghezza 40 cm e profondità regolabile da 20 a 25 cm.

COLORS



**KINTA**

Art. 7225153N

€ 47,90

63 x 27,5 x H22 cm

50 x 26 x H4,5 cm

2,5 kg

150 kg

Gradino singolo facilmente trasportabile dotato di gambe pieghevoli. La superficie del gradino è realizzata in plastica antiscivolo per offrire la massima sicurezza possibile in entrata e in uscita dal veicolo. Dimensioni molto compatte quando ripiegato.

**RUCKSTEP**

Art. 7225147N

€ 99,90

61 x 60 x H20/40 cm

81 x 61 x 6,5 cm

6,4 kg

150 kg



Gradino doppio compatto e chiudibile con telaio in metallo e coprigradino anti-slip.

**RUCKSTEP ALU**

Art. 7225149N

€ 114,90

51,5 x 53 x H19,5/38,5 cm

51,5 x 9 x H75,5 cm

4 kg

150 kg

Gradino doppio per caravan e camper. Struttura pieghevole in alluminio, leggera e robusta. Con superficie antiscivolo. Facile da trasportare e riporre.

**GO STEP NG**

Art. 7225127N

€ 81,90

48 x 30 x H23 cm

48 x 30 x H7 cm

2,65 kg

150 kg

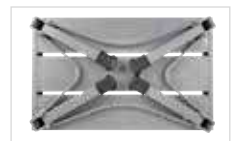

Gradino molto stabile con gambe pieghevoli. Robusta costruzione in alluminio verniciato a polveri.

**PRIMA**

Art. 7225134N

€ 87,90

55 x 61 x H18/37,5/43 cm

67 x 7 x 51 cm

5,5 kg

150 kg



Gradino doppio smontabile realizzato in solido metallo zincato.



BOXSTEP NG

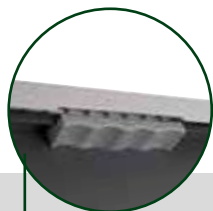

BRUNER



BOXSTEP NG

Art. 7225160N

€ 89,90

58 x 38 x H 24,5 cm

3,92 kg

150 kg

Gradino per veicoli ricreazionali di nuova concezione con spazio interno impermeabile per accessori utili, come attrezzi, liquidi sanitari, prolunghe, ecc. Il coperchio chiudibile mediante gancio a leva è dotato di un profilo antiscivolo ed è dotato anche di una luce solare di sicurezza integrata. Costruzione in plastica di alta qualità, molto stabile, con piedini rotanti per la regolazione del livellamento.





PLYER

Art. 7225138N.C06

€ 23,90

- 40 x 28 x H23,1 cm
- 40 x 38,2 x 5,5 cm
- 1,3 kg
- 120 kg

Pratico gradino pieghevole per Outdoor e uso casalingo in materiale plastico. Superficie antiscivolo e piedi in gomma.

RIALTO

Art. 7225140N

€ 39,90

- 45 x 30 x H23 cm
- 45 x 38,5 x 4,5 cm
- 2,3 kg
- 150 kg

Gradino pieghevole compatto per caravan, campeggio e casa. Costruzione in plastica robusta e resistente. Con rivestimento antiscivolo. Facile da piegare e riporre.

WINK

Art. 7225148N

€ 26,90

- 44,5 x 26,5 x H25,2 cm
- 55 x 27,5 x 8,3 cm
- 1,45 kg
- 120 kg

Gradino pieghevole in plastica con ampia superficie calpestabile e pratiche maniglie per il trasporto. Pronto all'uso in pochi secondi. Costruzione robusta e affidabile. Molto compatto e facile da riporre quando ripiegato.



PODIUM L

Art. 7225146N

€ 12,50

- 50 x 34 x H23 cm
- 1,3 kg
- 150 kg

Gradino in polietilene ad alta densità per veicoli ricreazionali. Esecuzione solida e stabile. Superficie calpestabile antiscivolo. Impilabile.

GAMUT

Art. 7225129N

€ 12,90

- 49,5 x 34,5 x 23,5 cm
- 1 kg
- 120 kg

Classico gradino per caravan. Completamente realizzato in resistente materiale plastico.

HOPPER ANTISLIP

Art. 7225142N.C06

€ 24,90

- 40,5 x 25 x H24,5 cm
- 1,45 kg
- 150 kg

Gradino in plastica per veicoli ricreazionali, con tappetino antiscivolo.



OUTBOX

Box in alluminio extra robusti e di alta qualità con uno spessore delle pareti di 1,0 mm. Ideali per lo stivaggio ed il trasporto in sicurezza di attrezzatura importante e di valore grazie alla loro costruzione a tenuta stagna.

CARATTERISTICHE:

- Realizzati in lamiera di alluminio di alta qualità
- Spessore delle pareti di 1,0 mm
- Impermeabile, resistente alle intemperie e alle temperature
- Con bordo di rinforzo su tutto il perimetro
- Robusto coperchio di chiusura
- Con 2 maniglie laterali a molla auto ripiegabili
- 2 chiusure a leva solide e facili da usare
- Guarnizione in gomma su tutto il perimetro del coperchio



OUTBOX ALU 47

Art. 7440011N

€ 179,00

OUTBOX ALU 73

Art. 7440012N

€ 199,00

OUTBOX ALU 92

Art. 7440013N

€ 249,90

58,2 x 38,5 x 26,2 cm

4,4 kg

47 l

58,2 x 38,5 x 39,7 cm

5,2 kg

73 l

78,2 x 38,5 x 36,7 cm

6,1 kg

92 l



NETRAY HD SMALL

Art. 0420015N

€ 25,50

32,5 x 18 x 8 cm

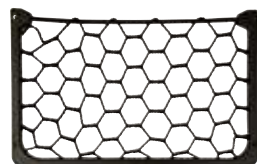

NETRAY

Art. 0420012N

€ 8,90

31,5 x 21 cm

160 g

NETRAY HD MEDIUM

Art. 0420016N

€ 28,90

39 x 20 x 8 cm

Rete porta oggetti con bordi in metallo e relativa copertura in materiale plastico. Fissaggio tramite viti.

NETRAY HD LARGE

Art. 0420018N

€ 32,50

44 x 22,5 x 8 cm

Retina portaoggetti elegante e funzionale composta da un robusto telaio in alluminio verniciato e da una rete elastica. Installazione semplice mediante viti. Disponibile in 3 misure.



FORT KNOX

Art. 7511005N

€ 19,90

20,5 x 15,5 x 8 cm

1,5 kg

Piccolo porta-valori per camper e caravan.



LADDY



LADDY AIR

Art. 7225118N

€ 199,90

293 x 47 x 8,4 cm

75 x 47 x 8,4 cm

7,5 kg

150 kg



Scala telescopica in alluminio con nuova tecnologia di chiusura morbida servoassistita che elimina il rischio di lesioni alle dita. Facile da trasportare e regolabile in altezza. Dotata di piedini in gomma antiscivolo per una maggiore sicurezza. Molto compatta quando chiusa.

LADDY ALCOVE

Art. 7225121N

€ 138,50

210 x 36 x 6 cm

67 x 36 x 6 cm

4,5 kg

150 kg



Scala telescopica in alluminio per mansarde. Permette un facile accesso ai letti. Con 2 ganci di fissaggio. Facile da trasportare e regolabile in altezza. Dotata di piedini in gomma antiscivolo per una maggiore sicurezza. Molto compatta quando chiusa.



TRANSAT ALU

Art. 7512015N

€ 57,50

H122 cm

1,25 kg



Treppiede pieghevole ultraleggero per antenna satellitare in alluminio anodizzato, Ø 40 mm.



GRIPPER

Art. 7110117N

€ 27,50

74 x 22,5 cm

750 g

PACK 2X



Griglia di partenza con scheletro diagonale. Materiale: PP resistente ai raggi UV.

TRACTOR

Art. 7110118N

€ 30,90

60 x 18 cm

30 x 18 cm

960 g

PACK 2X



Griglie di partenza pieghevoli in resistente materiale plastico.



EXTRA STRONG

ALU JACK 2.0

Art. 7140001N

€ 37,90

16 x 16 x H29/42 cm

2x 3,2 kg

1,5 t / Jack

Set di martinetti in alluminio con piastra di supporto a L angolata in acciaio zincato e copertura di protezione antiscivolo in plastica morbida. Costruzione molto stabile e impilabile. In set di 2.



OPTIONAL

ALU JACK PROTECTOR

Art. 7140003N

€ 4,90

PACK 2X

Copertura antiscivolo in plastica morbida per martinetti in alluminio con piastra di supporto angolata. Protegge la superficie di appoggio da graffi. Montaggio semplice.



EXTRA STRONG

POWER JACK

Art. 7140010N

€ 44,50

2x 2,15 kg

2x 1t

PACK 2X

Set martinetti realizzati in materiale di qualità resistente al freddo ed ai raggi UV.

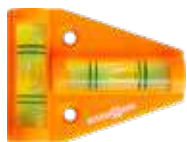

TRIANGLE

Art. 0115009C

€ 4,90

58 x 45 mm

PACK 1X

Livella a bolla triangolare con bolle perpendicolari e fori di fissaggio.



NIVEAU

Art. 0115011C

€ 8,90

100 x 35 x 12 mm

PACK 1X

Livella a bolla rettangolare con bolle perpendicolari.



LEVEL

Art. 0115005N

€ 11,50

230 x 40 x 16 mm

Livella con doppia bolla. Struttura in plastica. Magnetico.

**CARAPAD**

Art. 7110102N

€ 16,50

18 x 14,5 cm

PACK 4X

Piastrine di sostegno per roulotte in materiale plastico resistente.

**CARAPAD HD**

Art. 7110106N

€ 25,50

18 x 14,5 cm

2x 2t

PACK 4X

Basi antisprofondamento per caravan con perno di fissaggio in metallo.

**BASEPAD**

Art. 7110116C.C19

€ 28,90

Ø 16 cm

PACK 4X

Basi antisprofondamento in resistente materiale plastico.



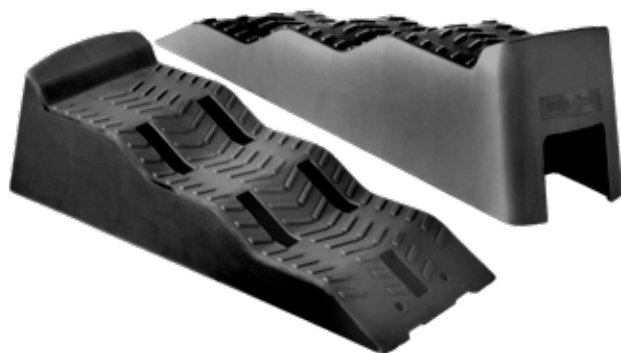

EQUALIZER XL BLACK

Art. 7110105N.C03

€ 42,90

UV
RESISTANT

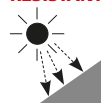

made in
EU

 56,2 x 20,2 x H15 cm

 3,7 kg

 5t / axle

PACK 2X



Cuneo di livellamento di alta qualità a 3 livelli. Fornito con pratica sacca custodia e da trasporto.





LEVELER PARKING

Art. 7110107N

€ 59,90

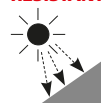
UV
RESISTANT



 61 x 21,5 x H12 cm

 2,25 kg

 5t / axle

PACK 2X





Cuneo livellatore a 3 livelli realizzato appositamente per le soste prolungate. Fornito con pratica sacca custodia.



RAMP SET

Art. 7110111N

€ 65,50

 64 x 22 x 14 cm 3,8 kg 3t / axle

PACK 2X



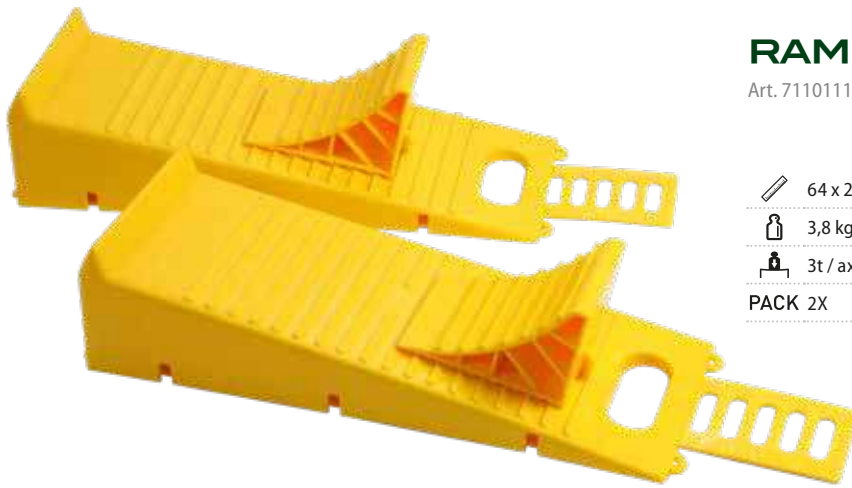

Set di livellamento composto da 2 cunei di livellamento, 2 cunei di arresto per bloccare il mezzo durante periodi di sosta prolungati e 2 piastre antiscivolo per terreni lisci.

**SKEYLA**

Art. 0712092N

€ 34,50

 H42,5 cm 570 g 50 - 100 kg

Bilancia pesatimone.

Ø 30 mm

Ø 36 mm

Ø 120 mm

**RUBBY**

Art. 7440008C 65 mm € 8,90

Art. 7440009C 125 mm € 9,90

Fermabauletti in gomma nera inalterabile, completi di supporto ed accessori in metallo.



SIGMA



PACK

Art. 7306368N	Flat Mirror	19 x 12 cm	640 g	1X	€ 42,50
Art. 7306369N	Convex Glass	19 x 12 cm	640 g	1X	€ 48,50

Specchio retrovisore supplementare universale.



ECLIPSE



Art. 7306375N

€ 52,50

19 x 12 cm

630 g

PACK 1X

Specchio retrovisore supplementare universale applicabile su specchi originali mediante morsetti a vite. Con asta di estensione laterale in metallo.



RIDER PRO

Art. 7306345N

€ 82,90

22 x 16 cm

2x 620 g

PACK 2X

Specchietto retrovisore universalmente montabile su quasi tutte le autovetture. Anche indicato per specchi originali di grandi dimensioni. Coppa aerodinamica di grandi dimensioni con speciale specchietto supplementare regolabile che rende visibile l'angolo morto. Fissaggio mediante 2 morsetti di bloccaggio a vite ed una cinghia supplementare di sicurezza regolabile in gomma. Fornito in coppia. Conforme alla normativa E11.



OROS ANG

Art. 7306328N

€ 34,50

14 x 20 cm

550 g

PACK 1X

Specchio universale Clip-on che si adatta quasi tutti gli specchi originali con vetro regolabile.

MIRROR COLLECTION





DELTA ANG

Art. 7306330N



€ 24,90

 18,5 x 12,5 cm

 420 g

PACK 1X

Specchio retrovisore supplementare da fissare agli specchietti laterali già di serie del mezzo. Utilizzabile sia a destra che a sinistra.



GAMMA ANG



PACK

Art. 7306335N.DS 22,5 x 16 cm 560 g 1X € 36,90

Art. 7306335N.PS 22,5 x 16 cm 560 g 1X € 36,90

Specchio retrovisore supplementare da fissare agli specchietti laterali del mezzo.



OPTILUS

Art. 7307103N



COLORS € 25,50

 C03

 14,5 x 6 x 4,5 cm

 160 g

PACK 1X

Specchio angolo morto per camper e automobili.



RETRAL

Art. 7307104N

€ 38,90

 14,5 x 6 x 4,5 cm

 146 g

Speciale specchio retrovisore realizzato per tenere sotto controllo l'abitacolo di camper e vetture.



INDICE

A

Accendino USB	302
Accessori elettrici 12V	350-353
Accessori gas	304,305
Accessori per amache	141-143
Accessori per gazebo	81
Accessori viaggio	144-149
Adattatori 13 poli	350
Alimentatore elettrico	326
Allarme fughe gas	335
Amache	141-143
Angolari di protezione	366
Appendiabiti a gancio	316
Armadietto pensile	211
Articoli in silicone/TPE	310
Aspirapolvere 12V	342,343
Aspirapolvere ricaricabile 230V	342
Aste bloccastoviglie	319
Avvolgicavo	351
Avvolgitubo	360

B

Bacinelle	307-309
Basi antisprofondamento	98,393
Basi per gazebo	81
Bauli per trasporto	390
Bicchieri	264-273,311
Bilancia pesabombole	145,334
Bilancia pesatimone	395
Bocca erogazione automatica	357
Boccali inox	260
Boccali termici	260
Bollitore elettrico	292
Bollitori	292
Bombolette gas	300
Borse Com-Pack	146
Borse da viaggio	145,146
Borse termiche	327-329
Borse trasporto	147,384 385,390
Bottiglie inox	330
Bottiglie termiche	330,331
Bottoni a pressione	102
Brandine	178,179

C

Candele citronella	149
Caffettiera	293
Caraffe	269
Carrelli portatutto	184,185
Carretto portatutto	182,183,184
Cartelli carichi sporgenti	383
Cassaforte	390
Cassetta portaoggetti	388
Cavi e adattatori	351-353

Cestini pensili	315
Cestino portarifiuti	312-315
Cesto multiuso	307
Cinghie di fissaggio	59, 95
Ciotola cani	260
Colapasta	291
Compressore 12V	337
Conchiglie paravento/sole	72,73
Contentore per zampironi	149
Contentori termici	330
Coperchi pentole	295
Coperchio per Vinis	307,308
Coperta di emergenza	146
Coperta in pile	130
Coperte pic-nic	139
Copertura camper	366,367,370
Copertura caravan	368,369,371
Coperture di protezione	372,373 382,383
Copribombola gas	373,375
Coprioblò	372
Copriredili igienici	148,359
Coprivolante	375
Corde di tensione	93
Corde elastiche	95
Cubetti ghiaccio	270
Cunei d'arresto	394,395
Cunei di stazionamento	394,395
Cuscini poggiatesta	137
Custodie impermeabili	147

D

Distanziatori coperture	366
Divani	170,171
Detergenti	362,363
Doccia da viaggio	358
Doccia solare	358

E

Elastici per tende	94,95
--------------------	-------

F

Fermabauletti	395
Fornelli a gas	298-303
Frigobox elettrici 12/230V	322-326

G

Ganci	92
Gazebo	68-71 78-81
Gazebo per Outdoor	68-71
Gazebo pieghevoli	78-81
Ghirbe e taniche	356
Gonfiatore 12V	136,337
Gradini	386-389
Grembiule paravento	375
Griglia di partenza	392
Grill da tavolo	300,301
Grill portatili	300,301

I

Imbuto	311,355
Impermeabilizzanti	362
Inserito per paniere	307
Inverter	333

K

Kit collegamento tende minibus	58
--------------------------------	----

L

Lampada veranda	123,346,348
Lampade da campeggio	119-121
Lampade frontali	122-123
Lavatrice da viaggio	343
Lavello pieghevole	147,307-310
Lettoni da campo	140,176
Livelle a bolla	392
Luce armadio	345
Luce entrata	345

M

Martelli da campeggio	96
Martinetti	392
Materassini autogonfianti	132,134
Materassini isolanti	138
Materassini pneumatici	132-135
Materassini ultraleggeri 6 tubi	133
Materassino da spiaggia	138
Mattonelle ghiaccio	328
Mensole	319
Mepo Box	277
Mobiletti cucina	206-213
Mobiletti per tende	206-213
Mobili armadi	206,207,209
Morsetto di stabilizzazione	98
Morsetti bloccapali	98
Morsetti bloccatiloni	103

N

Necessaire da viaggio	148
-----------------------	-----

O

Occhielli	102
Oliera/acetiera	240
Ombrelloni parasole	82-85
Omni-Box	291
Oscuranti termici	372,374 376,377

P	
Pale/zappe	96
Pali supplementari tende	97,100,101
Palo antibufera	101
Palo telescopico alluminio	99
Paniere multiuso	308
Paravento	74,75
Paravento fornelli	210,295
Pareti laterali per gazebi	68-71,81
Pareti laterali per tendalini	59
Pedane	114
Pentolame alluminio	276-287 294,295
Pentolame inox	288-291
Phon da viaggio	336
Piastra di cottura	295
Piastra di cottura elettrica	340,341
Piastra grill	301
Picchetti in metallo	88-91
Picchetti in plastica	88
Picchetti porta-ombrelloni	85,3
Pinza prendipentola	288,295
Plafoniere	344,345
Poltrone pieghevoli	171
Pompe acqua ad immersione	357
Pompe di gonfiaggio	58,136
Poncho impermeabile	146
Portabicchieri	201,311,319
Portapiatti	319
Portasacchetto rifiuti	313
Portaspezie	240
Portoggetti	261,311
Posacenere	246,248,250
Posate	260,262,263
Posate cucina	287
Prodotti chimici	362
Profilo di collegamento	99
Profilo di scorrimento	99
Profilo in alluminio	99
Prolunghe	353
Puntale palo	98
R	
Rete portaoggetti	390
S	
Sacche custodia	303
Sacche impermeabili	147
Sacchetti portarifiuti	315
Sacchi lenzuolo	130
Sacchiletto	126-131
Sacchetto ultraleggero	131
Saliera/Pepiera	248
Scale pieghevoli	391
Scolapiatti	311
Scopa per tende e verande	318
Secchiello pieghevole	307
Secchio multiuso	147,307

Sedie Action	168,172-175
Sedie pieghevoli	151-165
Sedie regista	167
Sedie Relax	153,159
Seggiolone per baby	169
Serbatoi mobili	355
Set paletta/scopetta	318
Sfera bloccateloni	103
Sgabelli	177
Spazzola lavaggio telescopica	361
Spazzola lava stoviglie	310
Spazzolini WC	361
Specchi retrovisori	396,397
Spiaggine	180,181
Spine e prese 12V	350
Spine e prese 13P	350
Spine e prese 220V	352,353
Staccabatteria	350
Stendibiancheria	316,317
Stoviglie in melamina	220-259
Stufetta a gas	298
Stufetta ad aria	338,339
Stufette elettriche	338,339
Stuoia antiscivolo	319
Stuoia spiaggia	138
Stuoie per verande	106-113
Stuoie protezione	106-113
T	
Taglieri	239,241,142 246,249,256 257
Tappeti	379
Tappeti cabina	378,380,381
Tappo adattatore con raccordo	360
Tavoli da campeggio	187-205
Tavolo sgabello	174,175
Tazza inox	260
Telaio portarifiuti	312
Telaio portafrigo	324
Teloni	102,103
Tendalino camper	54,55,56
Tendalini caravan	57
Tende	8-45
Tende cucina	60-64
Tende Family	20-27
Tende Minibus	34-37/40-43 46/49
Tende multifunzionali	65-67
Tende per porte	116,117
Tende pneumatiche	22-25/34-37 40-41
Tende portellone posteriore	50-53
Tenditori	92
Tostapane per fornelli	295
Treppiede antenna	391
V	
Ventilatore frigo	333

Ventilatori	336
Ventose per tende minibus	59,92
Ventose per oscuranti termici	374
Veranda gonfiabile	42-44
Verande ultraleggero	45
W	
WC portatile	359
Z	
Zaini termici	329
Zampironi antizanzare	149
Zanzariera coprivivande	311
Zanzariere	149,365
Zanzariciller	349
Zerbini	115



GARANZIA

I prodotti originali Brunner sono realizzati con materiali di ottima qualità, tenendo conto dell'utilizzo al quale verranno normalmente sottoposti. Severi controlli di qualità hanno lo scopo di fornire prodotti privi di difetti di materiale e/o di produzione. In caso si riscontrasse comunque uno dei difetti sopracitati, entra in azione la garanzia del prodotto che ha una durata di 24 mesi dalla data di acquisto.

ATTENZIONE:

La garanzia non copre difetti dovuti ad un utilizzo improprio o scorretto del prodotto stesso. Sono esclusi dalla garanzia anche difetti causati da un uso particolarmente prolungato del prodotto e dalla normale usura dei componenti che ne consegue.

L'articolo che presentasse i difetti sopra citati, dovrà essere consegnato al punto vendita in cui è stato effettuato l'acquisto, unitamente allo scontrino fiscale comprovante la data di tale transazione.

Il rivenditore provvederà ad effettuare tutte le operazioni necessarie per far pervenire il prodotto difettato alla Brunner srl o al distributore.

- Colori, misure e materiali dei prodotti e degli imballi sono indicativi e non impegnativi. Ci riserviamo di apportare modifiche tecniche ai prodotti illustrati.

Attenzione: i colori dei prodotti possono differire dall'originale per motivi tipografici. Non rispondiamo per eventuali errori di stampa.

- E' vietata la riproduzione, anche parziale, di testi, schemi, grafiche ed immagini contenuti nel presente catalogo.
- Loggettistica decorativa non è compresa nel prezzo indicato.
- Diritti riservati. Questo catalogo o ogni sua parte non può essere riprodotto senza l'autorizzazione della ditta Brunner s.r.l.



Benelux

Gimeg
Strijkviertel, 27
NL - 3454 PH De Meern
T: +31(0) 30 662 9500
sales@gimeg.nl
www.gimeg.nl

Estonia

Heidenline OÜ
Härgmäe, 24
EE - 13525 Tallinn
T: +372 50 19791
tellimused@matkasuvilad.ee

Greece

Zampetas
18 km Thessalonikis - Perea
GR - 570 19 Perea
T: +30 23920 71760
info@zampetas.gr
www.zampetas.gr

Norway

Caravan Supply AS
Teglverksveien, 100
N - 3057 Solbergelva
T: +47 32885533
post@casu.no
www.casu.no

Sweden

DCT Vejle A/S
Knud Højgaards Vej, 2
DK-7100 Vejle Denmark
T: +45 7582 4800
dct@dct-vejle.dk
www.dct-vejle.dk

Kama Fritid AB
Momarken 3
SE-556 50 Jönköping
T: +46.36.353723
info@kamafritid.se
www.kamafritid.com

Croatia

Meridian Nautika d.o.o.
Mate Vlašića, 24/A
HR - 52440 Poreč
T: +385(0) 52 453 096
info@meridian.hr
www.meridian.hr

Finland

Keha Caravan Tukku Oy
Koskelontie, 15
FIN-2920 Espoo
T: +358 40 7794595
palaute@caravantukku.fi
www.carvantukku.fi

Iceland

Vikurverk Ehf
Víkurbær, 6
IS - 203 Kópavogur
T: +354 557 7720
vikurverk@vikurverk.is
www.vikurverk.is

Poland

GoMarket.pl
Wybrzeże Gdynskie, 2
PL - 01-531 Warszawa
T: +48 (0)22 8392024
biuro@gomarket.pl
www.gomarket.pl

United Kingdom

Brunner UK
c/o Simon Cornall Associates Ltd
Birmingham Road, 95
GB - Allesley, Coventry - CV5 9GT
M: +44(0) 7931 248748
simonbrunneruk@gmail.com

Miriad Products
Dove Valley Park
GB-Foston-South Derbyshire DE65 5BG
T: +44(0) 1283 586060
info@miriad-products.com
www.miriad-products.com

Czech Republic

Brunner srl/GmbH
Via B. Buoizzi, 8
I - 39100 Bolzano
T: +39 0471 542900
info@brunner.it

France

Brunner srl/GmbH
Via B. Buoizzi, 8
I - 39100 Bolzano
T: +39 0471 542900
info@brunner.it

Israel

LaOfek Caravan & Camping
Hayetzira Street, 6
IL - 4951232 Petah-Tikva
T: +972-3-744-3344
info@laofek.co.il
www.laofek.co.il

Slovenja

TECA d.o.o
Cesta Ljubljanske Brigade, 9
SI - 1000 Ljubljana
T: +386 1 5838030
info@teca.si
www.caravan.si

Denmark

DCT Vejle A/S
Knud Højgaards Vej, 2
DK-7100 Vejle Denmark
T: +45 7582 4800
dct@dct-vejle.dk
www.dct-vejle.dk

Germany Austria Switzerland

Brunner srl/GmbH
Buozzistrasse, 8
I - 39100 Bozen
T: +39 0471 542900
info@brunner.it

New Zealand

Burnsco
Ronwood Avenue, 5
NZ - 2104 Manukau - Auckland
T: 0800 10 20 41
website@burnsco.co.nz
www.burnsco.co.nz

Spain and Portugal

Casmat Sport, S.L
Poligono Industrial Can Roses
Ctra. Molins a Sabadell, km 13, nave 21
08191 Rubi (Espana)
T: +34 93 588 75 39
info@casmatsport.com
www.casmatsport.com

Turkey

Akkale Dekorasyon San. Tic. Ltd.
Gürpınar Mah. 7237 sok. No:27/A
Bornova/ Izmir
T: +90 232 437 31 05
info@akkale.com.tr
www.akkale.com.tr

**Brunner International
Head Office • Italy**

Brunner srl/GmbH
Via B. Buoizzi, 8 • Buozzistrasse 8
I - 39100 Bolzano • Bozen
T: +39 0471 542900
info@brunner.it

**Brunner International
Hong Kong**

CampNow International LTD.
Room 1402, 14/Floor,
Yu Song Boon Building
107-111 Des Voeux Road Central,
Hong Kong
brunnerasia@brunnerinternational.com

BRUNNER A company from
SÜDTIROL