

FÒGHER

outdoor cooking design

CATALOGO PRODOTTI

PRODUCT CATALOG

2023





CATALOGO PRODOTTI
PRODUCT CATALOG

2023



INDICE INDEX

CUCINE DA ESTERNO OUTDOOR KITCHEN	06
CUCINA MODULARE LARES LARES MODULAR KITCHEN	08
CUCINA LARES SERIE INOX LARES INOX SERIES KITCHEN	26
CUCINA LARES SERIE GRES LARES GRES SERIES KITCHEN	52
MATERIALI E FINITURE MATERIALS AND FINISHES	78
BARBECUE A GAS GAS BARBECUE	82
METODI DI COTTURA COOKING METHODS	84
IL BARBECUE IN DETTAGLIO THE BARBECUE IN DETAIL	92
BARBECUE FGA FGA BARBECUE	100
BARBECUE FGA-FO FGA-FO BARBECUE	104
BARBECUE AD INCASSO FGB FGB BUILT-IN BARBECUE	112
BARBECUE AD INCASSO FGB-FO FGB-FO BUILT-IN BARBECUE	114
ACCESSORI DI COTTURA COOKING ACCESSORIES	118
SMOKER SMOKER	128
CUCINARE CON LO SMOKER A CARBONE COOKING WITH THE COAL SMOKER	130
LO SMOKER IN DETTAGLIO THE SMOKER IN DETAIL	132
SMOKER WS E RF WS AND RF SMOKER	142
CAMINETTO GRILL OUTDOOR FIREPLACE	148
TECNOLOGIA E DESIGN TECHNOLOGY AND DESIGN	150
IL CAMINETTO IN DETTAGLIO THE FIREPLACE IN DETAIL	152
CAMINETTO GRILL FFP 950 FIREPLACE FFP 950	158
MADE IN ITALY MADE IN ITALY	164
LA NOSTRA AZIENDA OUR COMPANY	166

TRADIZIONE, INNOVAZIONE, QUALITÀ

TRADITION, INNOVATION, QUALITY

CUCINE DA ESTERNO

OUTDOOR KITCHEN



CUCINA MODULARE LARES

LARES MODULAR KITCHEN

DISPONIBILE IN DUE SERIE: INOX E GRES
AVAILABLE IN TWO SERIES: INOX AND GRES

Pensiamo che ogni chef debba avere completa libertà mentre cucina, perciò abbiamo studiato e ideato una cucina modulare che possa adattarsi e soddisfare qualunque esigenza. Infatti, grazie ai numerosi moduli e ai sistemi di cottura Fògher siamo sicuri di accontentare anche lo chef più esigente.

We believe that each user has the right to freely express himself while cooking. That's why we have designed and conceived a modular kitchen that can meet any requirement. Our wide range of modules and cooking systems will also meet the needs of the most demanding chef.

COMPOSIZIONI CONFIGURATIONS

LINEARE | LINEAR



AD ANGOLO | L-SHAPED

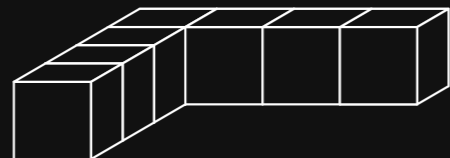

A FERRO DI CAVALLO | C-SHAPED

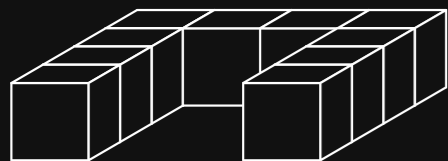

AD ISOLA | T-SHAPED

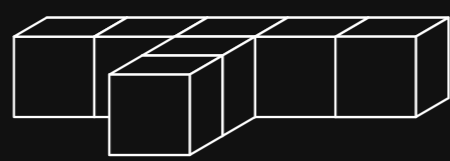

Creare la vostra cucina da esterno Lares è semplice, scegliendo tra i differenti moduli da 85, 385, 700 e 1000 mm e i diversi integrabili sistemi di cottura Fògher.

You can easily create your own Lares outdoor kitchen by choosing between the different modules, 85, 385, 700 and 1000 mm, and the diverse compatible cooking systems by Fògher.



MODULI CUCINA COOKING MODULES

La cucina che si adatta allo chef, non viceversa. Grazie alla versatilità dei moduli sarà possibile comporre una cucina estremamente funzionale capace di soddisfare tutte le necessità. Oltre a ciò, abbiamo creato dei pratici accessori, ideali per completare la vostra esperienza culinaria.

A kitchen that adapts to the chef, not vice versa. The versatility of the modules will help you configure an extremely functional kitchen, suitable for any need. Moreover, we created some practical tools that will make your culinary experience complete.

TIPOLOGIE MODULI TYPES OF MODULES



Neutro
Worktop



Cottura
Cooking



Supporto
Support



Lavello
Sink



Frigo
Fridge



Kit giunzione
Junction kit



Carenature e accessori
Doors and accessories



SISTEMI DI COTTURA FÒGHER FÒGHER COOKING SYSTEMS

Ogni alimento ha il suo principio di cottura. Che sia a gas, alla brace, o affumicato, siamo in grado di offrire la miglior esperienza possibile. Con i sistemi di cottura Fògher avrai a disposizione una selezione di strumenti per cucinare che porteranno i tuoi piatti ad altissimi livelli.

Each type of food requires a specific cooking method. Whether we talk about gas, embers, or smoke, we can grant the best possible experience. Fògher cooking systems include a wide range of cooking tools that will significantly improve the quality of your dishes.

TIPOLOGIE MODULI TYPES OF MODULES



BBQ a gas
Gas BBQ



BBQ ad incasso a gas
Built-in gas BBQ



Caminetto grill
Outdoor fireplace



Smoker
Smoker

CUCINA LARES SERIE INOX LARES INOX SERIES KITCHEN

Modulare e personalizzabile la cucina Lares offre tutta la flessibilità di cui avete bisogno. Le cucine della serie Inox sono caratterizzate da un utilizzo esclusivo del metallo, in particolare dell'acciaio inossidabile per componenti quali il piano di lavoro, i ripiani e il lavello. Con la cucina Lares serie Inox non si può sbagliare, è adattabile e compatibile con ogni esigenza grazie ad un piano facile da pulire, altamente igienico e utilizzabile anche in ambito professionale.

The modularity and customization of Lares series will grant all the flexibility you need. Inox series kitchens feature an exclusive use of metals. Component such as worktops, shelves and sinks are made of stainless steel. You can't go wrong with Lares Inox series, it will meet any of your needs. It is easy to clean, highly hygienic and can also be used for professional purposes.



CUCINA LARES SERIE GRES LARES GRES SERIES KITCHEN

Personalizzazione e qualità sono le parole d'ordine per la cucina Fògher Lares serie Gres, grazie a questo materiale infatti si possono ottenere cucine su misura dallo straordinario livello di carattere estetico che unito al sistema modulare e alla scelta di materiali e finiture dei diversi componenti permettono di progettare la vostra cucina in linea con le scelte estetiche dell'ambiente.

Customization and quality are the main features of Fògher Gres Lares kitchens. Thanks to stoneware, you can get extremely high-level custom-tailored kitchens. The modular system and the possibility to choose the materials and the finishes of the components will help you design your own kitchen, according to the aesthetics of your spaces.





QUALITÀ E PRATICITÀ QUALITY AND PRACTICALITY

Alcune delle caratteristiche che distinguono le cucine Fògher dal resto del mercato sono l'elevato grado di qualità dei materiali e di costruzione. La nostra continua ricerca tecnologica, lo studio di forme ed ergonomia sono tutti finalizzati all'ottenimento di prodotti pratici e affidabili, adatti sia all'uso casalingo ma ideali anche nel contesto professionale della ristorazione.

The high quality of materials and construction are what differentiates Fògher from the other kitchens in the market. Continuous technological research, the study of the shapes and ergonomics are all intended to grant practical and reliable products, suitable for both professional and non-professional purposes.

DETTAGLI TECNICI

Le cucine Lares sono semplici nella composizione e nell'utilizzo, ma dietro a ciò vi è una grande quantità di studio ed esperienza. Dal design all'assemblaggio, i nostri prodotti godono di un'eccezionale attenzione e cura del dettaglio, ciò ci permette di garantire al cliente qualità e una precisione straordinaria.



GAMBE E STRUTTURA IN ACCIAIO INOX VERNICIATO PAINTED STAINLESS STEEL FRAME AND STRUCTURE

L'acciaio verniciato è il materiale perfetto per la costruzione della struttura delle nostre cucine, robusto e resistente alla corrosione, permette alla cucina di essere posizionata all'esterno senza subire danni provocati dalle intemperie.

Varnished steel represents the perfect material for the frame of our kitchens. Thanks to its sturdiness and resistance to corrosion, kitchens can be placed outdoors without risking being spoiled by bad weather conditions.

PIEDINI DI REGOLAZIONE ESTENSIBILI ADJUSTABLE SUPPORT FEET

I piedini di regolazione permettono un livellamento perfetto di tutta la cucina, grazie alla gomma antiscivolo garantiscono un ancoraggio al suolo senza possibilità di distacco anche in caso di urti accidentali.

Adjustable feet allow the kitchen to be perfectly levelled thanks to non-slipper rubber and fixed to the ground, without running the risk of falling in the event of an accidental impact.



TECHNICAL DETAILS

Besides the ease of configuration and use, Lares kitchens derive from in-depth studies and practice. From designing to assembling, our products rely on exceptional attention and care for details. That's why we can guarantee extraordinary quality and precision.

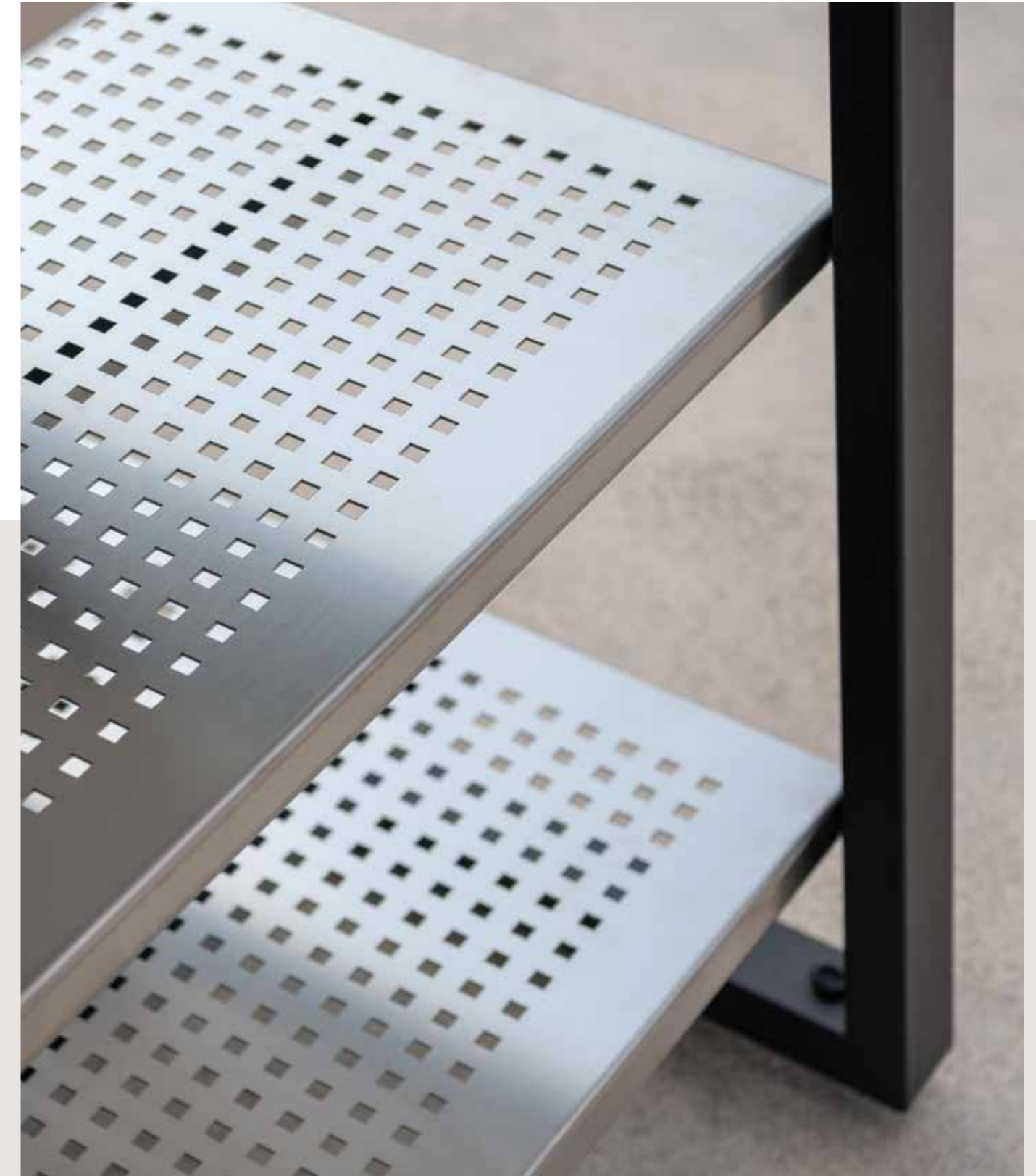

Produciamo oggetti che fanno riscoprire la serenità di vivere all'aria aperta e il piacere della condivisione tra amici e parenti. In questi momenti vogliamo poter realizzare qualsiasi pietanza senza limitazioni ai nostri desideri. Queste sono le basi su cui abbiamo sviluppato i nostri prodotti: fondere insieme tutte le funzionalità di una cucina tradizionale e il gusto intenso del miglior barbecue.

We produce objects that make people rediscover the serenity of outdoor life and the pleasure of sharing with family and friends. In such moments, we should be free to create any dish we desire. Starting off with these considerations, we developed our products: combining all the features of a traditional kitchen with the intense taste of the best barbecue.

RIPIANI IN ACCIAIO SATINATO RINFORZATO REINFORCED SATIN-FINISH STAINLESS STEEL SHELVES

Forti e resistenti, i ripiani presenti in tutte le cucine Fògher sono realizzati in acciaio satinato rinforzato, sono costruiti a partire da un unico foglio di metallo che viene piegato e lavorato per ottenere un ripiano solido ma che una volta perforato permette anche un completo scolo dell'acqua.

The satin-finish stainless steel shelves in each Fògher kitchen, strong and highly resistant, are made from a single sheet metal. The sheet is then cut and processed to get a solid shelf that allows the water to drain thanks to the perforated hole pattern.

CARENATURE IN METALLO ZINCO-MAGNESIO E ACCIAIO METAL, ZINC-MAGNESIUM AND STEEL DOORS

Le leghe metalliche utilizzate per creare le nostre cucine vengono forgiate utilizzando soltanto i materiali migliori: lo zinco e il magnesio si fondono per dare vita ad oggetti di design funzionali, longevi e resistenti. Le carenature con ante a battente permettono di avere dei pratici scompartimenti chiusi in cui riporre gli utensili ma consentono anche la realizzazione di composizioni più dinamiche con alternanza di vani chiusi e a giorno.

The metal alloys we use to realize our kitchens have been forged using only the best materials: zinc and magnesium combine to create durable, resistant objects with a functional design. Hinged doors allow you to have practical closed compartments where to store your tools, but also dynamic configurations with both open and closed compartments.



"Un rivoluzionario concetto di cucina outdoor per prestazioni ai massimi livelli, progettato per il vostro piacere".

"A revolutionary outdoor kitchen that guarantees top level performance, designed for your own pleasure".



CERNIERE METALLICHE AD ELEVATA RESISTENZA HIGHLY-RESISTANT STEEL HINGES

Le cerniere in acciaio Blum, utilizzate per le ante a battente, riuniscono una tecnica innovativa, un design premiato a livello internazionale e il comfort del movimento in pochissimo spazio grazie al meccanismo di ammortizzazione integrato nel fondello.

Blum steel hinges enclosed in our hinged doors combine innovative technique, internationally acclaimed design and ease of movement into a compact space thanks to the cushioning system on the bottom.



CASSETTI CON SISTEMA DI APERTURE PUSH-PULL PUSH TO OPEN DRAWERS

I cassetti sotto top sono disponibili in due misure, da 700 e da 1000 mm, sono costruiti in metallo e realizzati con apertura/chiusura push-pull ammortizzata. La parte a vista è verniciata con resine epossidiche termoindurenti per garantire una resistenza ineccepibile all'usura.

Steel top drawers are available in two versions, 700 and 1000 mm, and have a push to open dampening opening. Visible parts are painted with thermosetting epoxy powders that ensure impeccable wear resistance.



ELETTRODOMESTICI

Le composizioni Lares permettono di integrare i sistemi di cottura Fògher con eccellenti elettrodomestici selezionati per un'esperienza di cottura a 360°, senza limitare la vostra creatività in cucina.

PIANO COTTURA A GAS GAS HOBS

Gli elettrodomestici selezionati per le cucine Fògher sono frutto di una scelta e un'analisi meticolosa. Foster offre una proposta ampia e moderna di piani cottura a gas, dotati di bruciatori ad alta efficienza che risparmiano dal 20% al 25% il consumo di gas rispetto ai piani tradizionali.

The appliances selected for our kitchens are the result of an accurate analysis. Foster has a wide and modern range of gas hobs, each equipped with high-efficiency burners that will help you save up to 20-25% of gas consumption compared to traditional hobs.

PIANO COTTURA A INDUZIONE INDUCTION HOBS

La qualità del risultato dipende anche dalla qualità degli strumenti, perciò vogliamo fornire ai nostri clienti solo ottimi prodotti. Il piano cottura a induzione Foster garantisce prestazioni eccezionali per uno strumento adatto ad affrontare ogni tipo di piatto.

The quality of the final result is strictly connected to the quality of the tools. That's why we want to provide our customers only with excellent products. Foster induction hobs guarantee extraordinary performance in every dish.

APPLIANCES

Fògher cooking systems from Lares kitchens can be combined with excellent appliances, selected to guarantee a well-rounded cooking experience, without limits to your creativity.



"Una cucina da esterni che porta tutta l'esperienza d'uso della cottura indoor ad integrarsi con un lifestyle outdoor di altissimo livello."

"An outdoor kitchen combining all of the indoor kitchen features with the highest outdoor lifestyle standards."

FRIGORIFERO A CASSETTO DRAWER FRIDGE

Il frigo in acciaio presente nelle cucine Fögher è di tipo a cassetto, ha una capienza di 90 litri di cui 9,8 sono riservati al freezer. Grazie alla centralina bivalente è possibile far funzionare l'elettrodomestico sia in modalità DC 12/24V sia AC 250V, il consumo nominale è di 45W.

Fögher kitchens are equipped with a drawer fridge, with 90 liters capacity, including a 9,8 liters freezer. Thanks to the bivalent controlling system you can use the fridge both in DC 12/24V and AC 250V mode. Nominal power: 45W.

LAVELLO IN ACCIAIO INOX ANTIGRAFFIO SCRATCHPROOF STAINLESS-STEEL SINK

Lavello in acciaio inossidabile antigraffio con miscelatore a rotazione di 360° con piastra di rinforzo e doppio getto: a flusso o a pioggia.

A scratch proof stainless steel sink with a 360° mixer tap, reinforcement plate and dual jet: solid stream or rain effect.



CREA LA TUA CUCINA

Personalizza la tua cucina da esterni Lares, visita www.fogher.com e scopri il configuratore.

CREATE YOUR KITCHEN

Customize your Lares outdoor kitchen, visit www.fogher.com and explore our configurator.

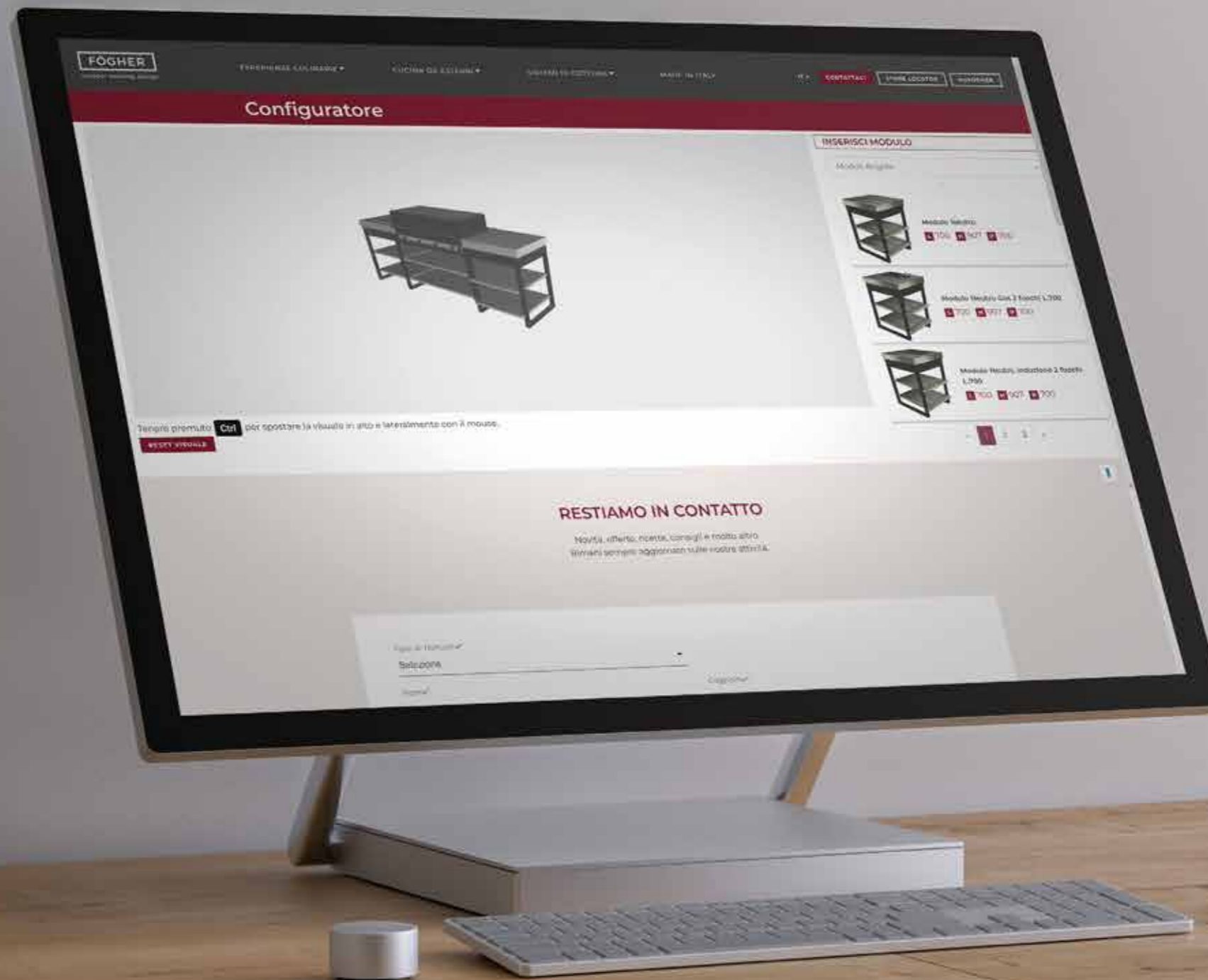



MISURE MODULI 85-385-700-1000 mm
MODULES MEASUREMENTS 85-385-700-1000 mm

CUCINA LARES SERIE INOX

LARES INOX SERIES KITCHEN

Le cucine modulari della serie Inox sono anche indicate per l'uso nella ristorazione professionale, grazie al loro piano di lavoro in acciaio inossidabile alimentare che garantisce un'eccellente resistenza all'usura di agenti chimici, detergenti e all'acqua. Le cucine in acciaio inox rappresentano una vera e propria tendenza, capaci di adattarsi perfettamente a qualsiasi stile.

Inox series modular kitchens are also intended for professional purposes, thanks to the stainless steel worktops, that make the surfaces resistant to chemicals, cleansers and water. Stainless steel kitchens represent a massive trend, being suitable for any style.



PIANO DI LAVORO IN ACCIAIO INOX ALIMENTARE INIETTATO

KITCHEN INJECTED STAINLESS STEEL WORKTOP

Il piano di lavoro in acciaio inossidabile alimentare satinato AISI 304 spesso 1 mm ha un'anima iniettata in materiale sintetico alleggerito che ne aumenta in maniera esponenziale la resistenza e l'indeformabilità, annullando gli effetti negativi causati da calore e intemperie. L'acciaio è resistente alla corrosione, facile da pulire grazie alla sua superficie priva di pori. Con l'ossigeno, l'acciaio inox crea uno strato protettivo passivo che si rigenera continuamente mantenendo brillantezza e durata nel tempo.

Satin-finish AISI 304 stainless steel worktop has a lightweight synthetic injected core that exponentially increases the resistance and non-deformability of the product, that may be caused by heat and bad weather conditions. Steel is wear resistant and easy to clean due to the smooth surface. Stainless steel, combined with oxygen, creates a protective layer that ensures brightness and durability over time.



COMPOSIZIONI PREDEFINITE CUCINA LARES SERIE INOX STANDARD CONFIGURATIONS LARES INOX SERIES KITCHEN



SOLUZIONI | SOLUTIONS

Materiali | Materials 

LI Composizione cucina FK001*
LI FK001 Kitchen configuration*

- Modulo lavello 1000
- Barbecue FGA 750 FO
- Modulo supporto BBQ FGA 750
- Modulo neutro 1000
- 2 x Ripiano intermedio modulo 1000
- Appendiera 2.9 m
- Kit manuale cucina Fògher
- Sink module 1000
- Barbecue FGA 750 FO
- FGA 750 barbecue support module
- Worktop module 1000
- 2 x middle shelf for 1000 module
- Frame 2.9 m
- Fògher kitchen manual

Cod. 1061059.1 - E--



LI Composizione cucina FK002*
LI FK002 Kitchen configuration*

- Modulo lavello 1000
- Barbecue FGA 750 FO
- Modulo supporto BBQ FGA 750
- Kit carenature modulo BBQ 750
- Modulo cottura a gas 1000 (2 fuochi)
- 2 x Kit carenature modulo 1000
- Appendiera 2.9 m
- Kit manuale cucina Fògher
- Sink module 1000
- Barbecue FGA 750 FO
- FGA 750 barbecue support module
- Doors kit for FGA 750 barbecue
- Gas cooking module 1000 (2 burners)
- 2 x Doors kit for 1000 module
- Frame 2.9 m
- Fògher kitchen manual

Cod. 1061060.1 - E--

* Comporre il codice con la variante finitura del piano di lavoro come indicato a pagina 78.

Il codice di vendita indicato è relativo alla certificazione CE dei sistemi di cottura. Per altre certificazioni, riferirsi alla tabella di conversione a pagina 80.

* Compose the code with the worktop finish variant as indicated on page 78.

The indicated sales code relates to the CE certification of the cooking systems. For other certifications, refer to the conversion table on page 80.

SOLUZIONI | SOLUTIONS

Materiali | Materials E**LI Composizione cucina FKC 004***

LI FKC 004 Kitchen configuration*

- Modulo lavello 1000
- Barbecue FGA 1000 FO
- Modulo supporto barbecue FGA 1000
- Kit carenature barbecue FGA 1000
- Modulo cottura a gas 1000 (2 fuochi)
- 2 x Kit carenature modulo 1000
- Kit manuale cucina Fògher

- Sink module 1000
- Barbecue FGA 1000 FO
- FGA 1000 barbecue support module
- Doors kit for FGA 1000 barbecue
- Gas cooking module 1000 (2 burners)
- 2 x Doors kit for 1000 module
- Fògher kitchen manual

Cod. 1064021.1 - E--

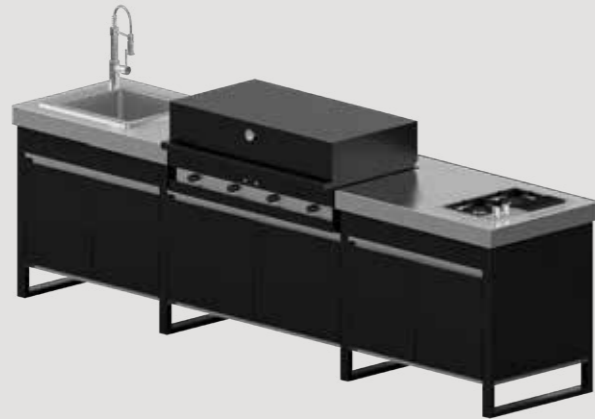
**LI Composizione cucina FKC 020***

LI FKC 020 Kitchen configuration*

- Barbecue FGA 750 FO
- Modulo supporto barbecue FGA 750
- Kit carenature barbecue FGA 750
- Modulo cottura gas 1000 (2 fuochi)
- Kit carenature modulo 1000
- Modulo neutro 85
- Kit manuale cucina Fògher

- Barbecue FGA 750 FO
- FGA 750 barbecue support module
- Doors kit for FGA 750 barbecue
- Gas cooking module 1000 (2 burners)
- Doors kit for 1000 module
- Worktop module 85
- Fògher kitchen manual

Cod. 1076933.1 - E--



SOLUZIONI | SOLUTIONS

Materiali | Materials E**LI Composizione cucina FKC 021***

LI FKC 021 Kitchen configuration*

- Barbecue FGA 750 FO
- Modulo supporto barbecue FGA 750
- Kit carenature barbecue FGA 750
- Modulo cottura gas 1000 (2 fuochi)
- Kit carenature modulo 1000
- Modulo neutro 85
- Appendiera 2.0 m
- Kit manuale cucina Fògher

- Barbecue FGA 750 FO
- FGA 750 barbecue support module
- Doors kit for FGA 750 barbecue
- Gas cooking module 1000 (2 burners)
- Doors kit for 1000 module
- Worktop module 85
- Frame 2.0 m
- Fògher kitchen manual

Cod. 1076934.1 - E--

**LI Composizione cucina FKC 022***

LI FKC 022 Kitchen configuration*

- Modulo lavello 700
- Barbecue FGA 500 FO
- Modulo supporto barbecue FGA 500
- Ripiano intermedio modulo BBQ 500
- Modulo neutro 700
- 2 x Kit carenature modulo 700
- Kit manuale cucina Fògher

- Sink module 700
- Barbecue FGA 500 FO
- FGA 500 barbecue support module
- Middle shelf for BBQ 500 module
- Worktop module 700
- 2 x Doors kit for 700 module
- Fògher kitchen manual

Cod. 1076935.1 - E--



* Comporre il codice con la variante finitura del piano di lavoro come indicato a pagina 78.

Il codice di vendita indicato è relativo alla certificazione CE dei sistemi di cottura. Per altre certificazioni, riferirsi alla tabella di conversione a pagina 80.

* Compose the code with the worktop finish variant as indicated on page 78.

The indicated sales code relates to the CE certification of the cooking systems. For other certifications, refer to the conversion table on page 80.

SOLUZIONI | SOLUTIONS

Materiali | Materials **LI Composizione cucina FKC 023***

LI FKC 023 Kitchen configuration*

- Modulo lavello 1000
- Barbecue FGA 750 FO
- Modulo supporto barbecue FGA 750
- Kit carenature barbecue FGA 750
- Modulo cottura a gas 1000 (2 fuochi)
- 2 x Kit carenature modulo 1000
- Kit manuale cucina Fògher

- Sink module 1000
- Barbecue FGA 750 FO
- FGA 750 barbecue support module
- Doors kit for FGA 750 barbecue
- Gas cooking module 1000 (2 burners)
- 2 x Doors kit for 1000 module
- Fògher kitchen manual

Cod. 1076936.1 - E--

**LI Composizione cucina FKC 024***

LI FKC 024 Kitchen configuration*

- Modulo lavello 1000
- Barbecue FGA 750 FO
- Modulo supporto barbecue FGA 750
- Modulo neutro 1000
- 2 x Ripiano intermedio modulo 1000
- Kit manuale cucina Fògher

- Sink module 1000
- Barbecue FGA 750 FO
- FGA 750 barbecue support module
- Worktop module 1000
- 2 x Middle shelf for 1000 module
- Fògher kitchen manual

Cod. 1076937.1 - E--

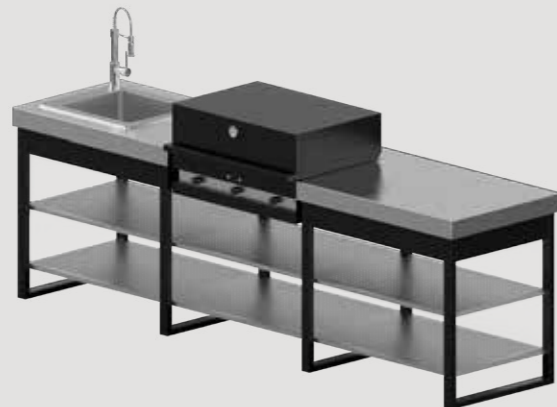

SOLUZIONI | SOLUTIONS

Materiali | Materials **LI Composizione cucina FKC 025***

LI FKC 025 Kitchen configuration*

- Modulo lavello 1000
- Modulo frigo neutro 700
- Modulo cottura a induzione 1000 (2 zone)
- Barbecue FGA 1000 FO
- Modulo supporto barbecue FGA 1000
- Modulo neutro 85
- 2 x Kit giunzione moduli
- 2 x Kit carenature modulo 1000
- Ripiano intermedio modulo BBQ 1000
- Cassetto sotto top modulo 1000
- Kit manuale cucina Fògher

- Sink module 1000
- Worktop fridge module 700
- Induction cooking module 1000 (2 zones)
- Barbecue FGA 1000 FO
- FGA 1000 barbecue support module
- Worktop module 85
- 2 x Modules junction kit
- 2 x Doors kit for 1000 module
- Middle shelf for BBQ 1000 module
- Under top drawer for 1000 module
- Fògher kitchen manual

Cod. 1076938.1 - E--



* Comporre il codice con la variante finitura del piano di lavoro come indicato a pagina 78.

Il codice di vendita indicato è relativo alla certificazione CE dei sistemi di cottura. Per altre certificazioni, riferirsi alla tabella di conversione a pagina 80.

* Compose the code with the worktop finish variant as indicated on page 78.

The indicated sales code relates to the CE certification of the cooking systems. For other certifications, refer to the conversion table on page 80.

**LI Composizione cucina FK026***

LI FK026 Kitchen configuration*

- Caminetto FFP 950
 - Modulo supporto caminetto
 - Modulo neutro 1000
 - Cassetto sotto top modulo 1000
 - Modulo frigo e induzione 700 + 300 (2 zone)
 - Modulo neutro 700 + 300
 - Kit giunzione angolo
 - Kit carenature modulo 385
 - Barbecue FGA 1000 FO
 - Modulo supporto barbecue FGA 1000
 - Kit carenature barbecue FGA 1000
 - Modulo lavello 1000
 - Kit carenature modulo 1000
 - 2 x Kit giunzione moduli
 - Kit manuale cucina Fògher
-
- 950 FFP Fireplace
 - Fireplace support module
 - Worktop module 1000
 - Under top drawer for 1000 module
 - Fridge and induction module 700 + 300 (2 zones)
 - Worktop module 700 + 300
 - Corner junction kit
 - Doors kit for 385 module
 - Barbecue FGA 1000 FO
 - FGA 1000 barbecue support module
 - Doors kit for FGA 1000 barbecue
 - Sink module 1000
 - Doors kit for 1000 module
 - 2 x Modules junction kit
 - Fògher kitchen manual

Cod. 1076939.1 - E--

* Comporre il codice con la variante finitura del piano di lavoro come indicato a pagina 78.

Il codice di vendita indicato è relativo alla certificazione CE dei sistemi di cottura. Per altre certificazioni, riferirsi alla tabella di conversione a pagina 80.

* Compose the code with the worktop finish variant as indicated on page 78.

The indicated sales code relates to the CE certification of the cooking systems. For other certifications, refer to the conversion table on page 80.

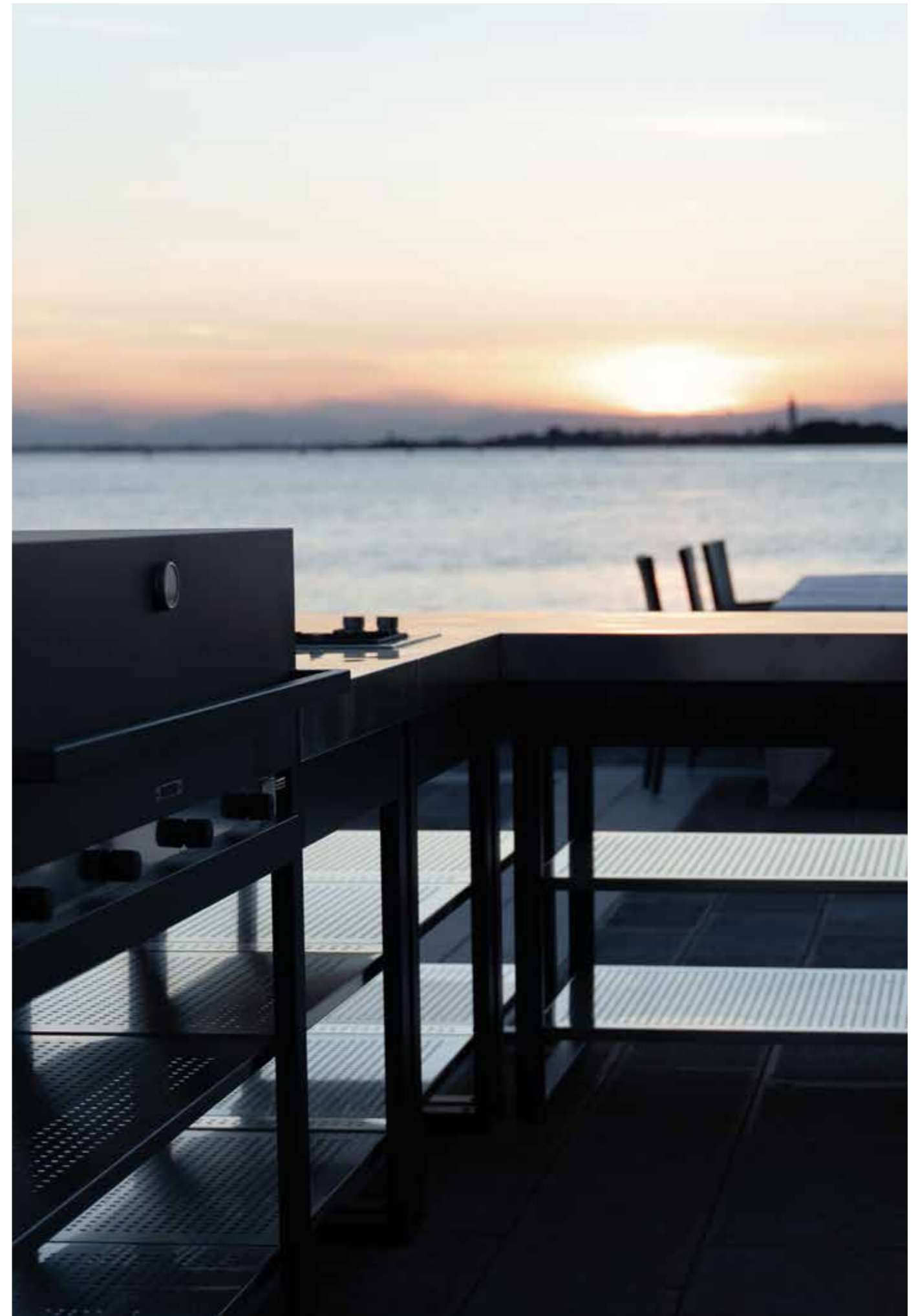

MODULI LARES SERIE INOX

LARES INOX SERIES MODULES

CUCINE DA ESTERNO | OUTDOOR KITCHEN

CUCINE DA ESTERNO | OUTDOOR KITCHEN

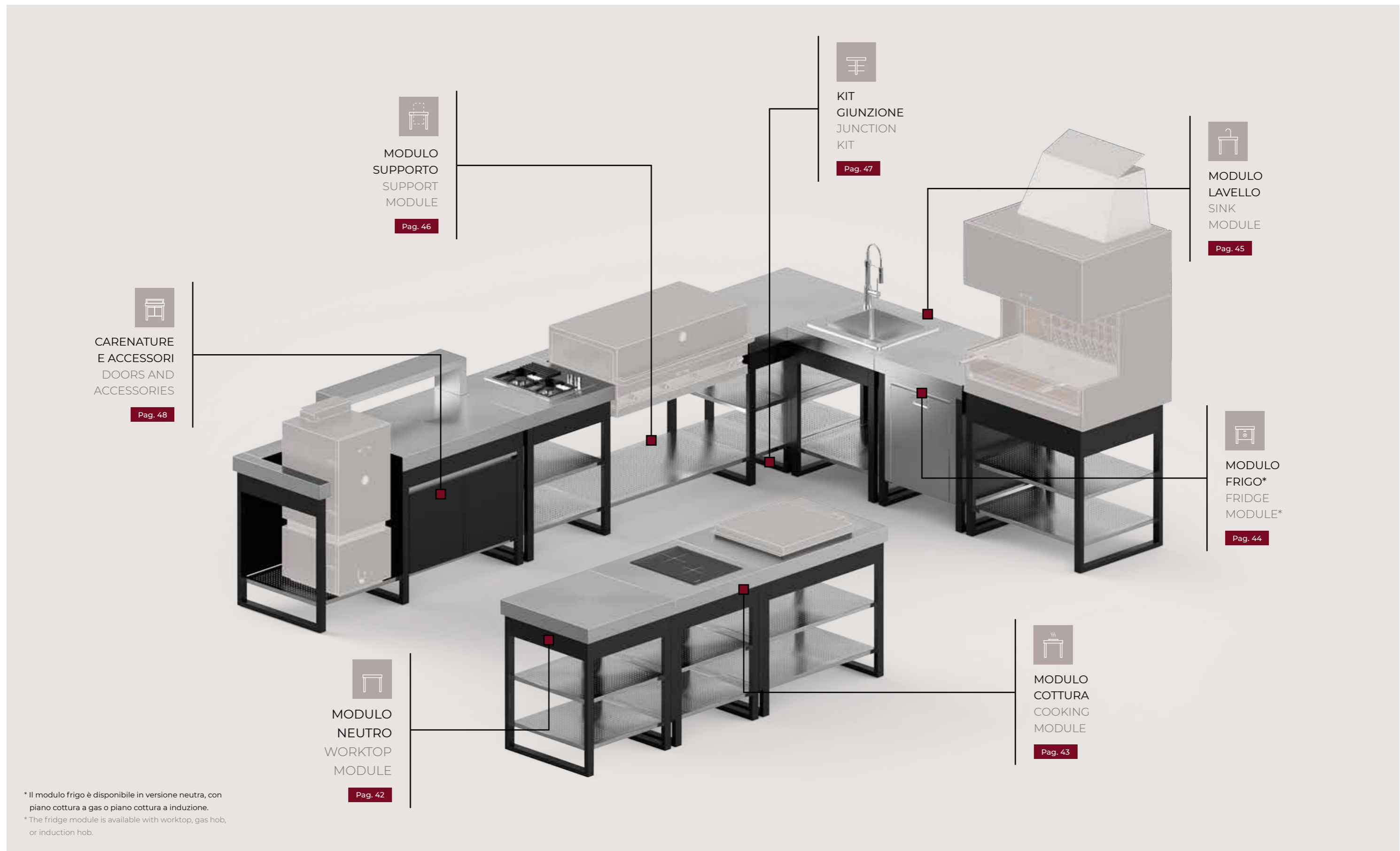

MODULO
SUPPORTO
SUPPORT
MODULE

Pag. 46



KIT
GIUNZIONE
JUNCTION
KIT

Pag. 47



MODULO
LAVELLO
SINK
MODULE

Pag. 45



CARENATURE
E ACCESSORI
DOORS AND
ACCESSORIES

Pag. 48



MODULO
FRIGO*
FRIDGE
MODULE*

Pag. 44



MODULO
NEUTRO
WORKTOP
MODULE

Pag. 42



MODULO
COTTURA
COOKING
MODULE

Pag. 43

* Il modulo frigo è disponibile in versione neutra, con piano cottura a gas o piano cottura a induzione.
* The fridge module is available with worktop, gas hob, or induction hob.

SISTEMI DI COTTURA

COOKING SYSTEMS



BARBECUE A GAS FGA FGA GAS BARBECUE

Modelli compatibili:
Compatible models:

FGA 500
FGA 500 FO
FGA 750
FGA 750 FO
FGA 1000
FGA 1000 FO

Per maggiori informazioni vedere
il capitolo **Barbecue a gas**.
For further information, please see
chapter Gas barbecue.

Pag. 82



SMOKER SMOKER

Modelli compatibili:
Compatible models:

WS 450
RF 450

Per maggiori informazioni
vedere il capitolo **Smoker**.
For further information, please
see chapter Smoker.

Pag. 128



CAMINETTO GRILL OUTDOOR FIREPLACE

Modelli compatibili:
Compatible models:
FFP 950

Per maggiori informazioni vedere
il capitolo **Caminetto Grill**.
For further information, please
see chapter Outdoor fireplace.

Pag. 148



BARBECUE A GAS FGB FGB GAS BARBECUE

Modelli compatibili:
Compatible models:

FGB 250
FGB 500
FGB 500 FO

Per maggiori informazioni vedere
il capitolo **Barbecue a gas**.
For further information, please
see chapter Gas barbecue.

Pag. 82

* Per abaco sistemi di cottura compatibili fare riferimento a pagina 40-41.

* For the compatible cooking systems abacus visit page 40-41.

SISTEMI DI COTTURA COMPATIBILI CON CUCINE LARES

LARES KITCHEN COMPATIBLE COOKING SYSTEMS

SISTEMI DI COTTURA | COOKING SYSTEMS

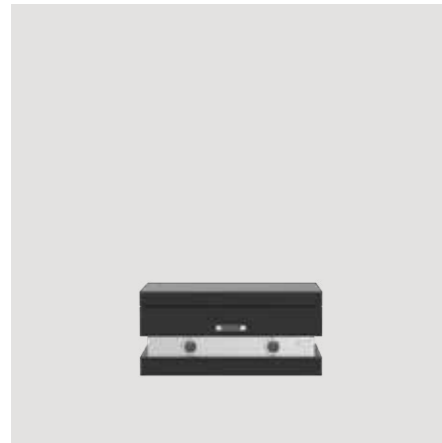

Per maggiori informazioni vedere il capitolo
Barbecue a gas. (pag. 82) | For further information,
please see chapter Gas barbecue. (pag. 82)

Barbecue FGA 500*
FGA 500 Barbecue*

Cod. 1072484.1



Per maggiori informazioni vedere il capitolo
Barbecue a gas. (pag. 82) | For further information,
please see chapter Gas barbecue. (pag. 82)

Barbecue FGA 500 FO*
FGA 500 FO Barbecue*

Cod. 1072485.1



Per maggiori informazioni vedere il capitolo
Barbecue a gas. (pag. 82) | For further information,
please see chapter Gas barbecue. (pag. 82)

Barbecue da incasso FGB 250*
Built-in barbecue FGB 250*

Cod. 1071584.1



Per maggiori informazioni vedere il capitolo
Barbecue a gas. (pag. 82) | For further information,
please see chapter Gas barbecue. (pag. 82)

Barbecue ad incasso FGB 500 FO* **
Built-in barbecue FGB 500 FO* **

Cod. 1072503.1



Per maggiori informazioni vedere il capitolo
Smoker. (pag. 128) | For further information, please
see chapter Smoker. (pag.128)

Smoker WS 450*
WS 450 smoker*

Cod. 1062131.0



Per maggiori informazioni vedere il capitolo
Caminetto Grill. (pag.148) | For further information,
please see chapter Outdoor fireplace. (pag. 148)

Caminetto FFP 950*
950 FFP Fireplace*

Cod. 1077329.0

Barbecue FGA 750*
FGA 750 Barbecue*

Cod. 1070463.1

Barbecue FGA 750 FO*
FGA 750 FO Barbecue*

Cod. 1070493.1

Barbecue da incasso FGB 500*
Built-in barbecue FGB 500*

Cod. 1072502.1

Smoker RF 450*
RF 450 smoker*

Cod. 1075715.0

Barbecue FGA 1000*
FGA 1000 Barbecue*

Cod. 1071440.1

Barbecue FGA 1000 FO*
FGA 1000 FO Barbecue*

Cod. 1071742.1

* Il codice di vendita indicato è relativo alla certificazione CE dei sistemi di cottura. Per altre certificazioni, riferirsi alla tabella di conversione a pagina 80.
* The indicated sales code relates to the CE certification of the cooking systems. For other certifications, refer to the conversion table on page 80.

** Il Barbecue ad incasso FGB 500 FO non può essere posizionato a ridosso di una parete ma deve essere installato su un modulo ad isola.
** The built-in barbecue FGB 500 FO cannot be positioned close to a wall but must be installed on an isle module.

MODULI E KIT CUCINA LARES SERIE INOX

LARES INOX SERIES MODULES AND KITS

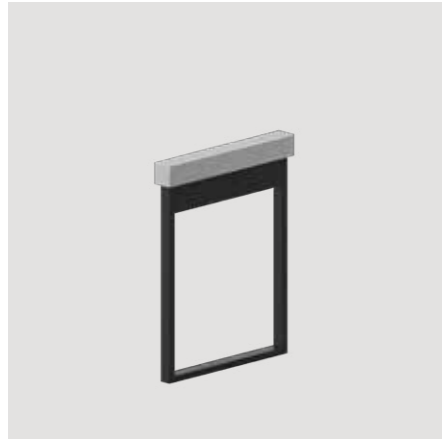

MODULI NEUTRI | WORKTOP MODULES

Materiali | Materials E

LI Modulo neutro 85*
LI Worktop module 85*

Misure (LxP) | Measures (WxD)
85 x 700 mm
Peso | Weight 8,5 kg

Cod. 1068488.0 - E--



LI Modulo neutro 385*
LI Worktop module 385*

Misure (LxP) | Measures (WxD)
385 x 700 mm
Peso | Weight 23 kg

Cod. 1069506.0 - E--



LI Modulo neutro 700+300*
LI Worktop module 700+300*

Misure (LxP) | Measures (WxD)
1000 x 700 mm
Peso | Weight 50 kg

Cod. 1069822.0 - E--

LI Modulo neutro 700*
LI Worktop module 700*

Misure (LxP) | Measures (WxD)
700 x 700 mm
Peso | Weight 33 kg

Cod. 1063534.0 - E--

LI Modulo neutro 1000*
LI Worktop module 1000*

Misure (LxP) | Measures (WxD)
1000 x 700 mm
Peso | Weight 42 kg

Cod. 1063487.0 - E--

* Comporre il codice con la variante finitura del piano di lavoro come indicato a pagina 78.

Il codice di vendita indicato è relativo alla certificazione CE dei sistemi di cottura. Per altre certificazioni, riferirsi alla tabella di conversione a pagina 80.

Frigo, lavello, piano cottura a gas e a induzione sono installabili sia a sinistra che a destra del modulo.

* Compose the code with the worktop finish variant as indicated on page 78.

The indicated sales code relates to the CE certification of the cooking systems. For other certifications, refer to the conversion table on page 80.

Fridge, sink, gas and induction hob can be installed both on the left and on the right of the module.



MODULI COTTURA | COOKING MODULES

Materiali | Materials E

LI Modulo cottura gas 700 (2 fuochi)*
LI Gas cooking module 700 (2 burners)*

Misure (LxP) | Measures (WxD)
700 x 700 mm
Peso | Weight 35 kg

Cod. 1063930.1 - E--



LI Modulo cottura induzione 700 (2 zone)*
LI Induction cooking module 700 (2 zones)*

Misure (LxP) | Measures (WxD)
700 x 700 mm
Peso | Weight 33 kg

Cod. 1063931.1 - E--



LI Modulo cottura gas 700+300 (2 fuochi)*
LI Gas cooking module 700+300 (2 burners)*

Misure (LxP) | Measures (WxD)
1000 x 700 mm
Peso | Weight 52 kg

Cod. 1069834.1 - E--

LI Modulo cottura gas 1000 (2 fuochi)*
LI Gas cooking module 1000 (2 burners)*

Misure (LxP) | Measures (WxD)
1000 x 700 mm
Peso | Weight 43 kg

Cod. 1063925.1 - E--

LI Modulo cottura induzione 1000 (2 zone)*
LI Induction cooking module 1000 (2 zones)*

Misure (LxP) | Measures (WxD)
1000 x 700 mm
Peso | Weight 41 kg

Cod. 1063926.1 - E--



LI Modulo cottura induzione 700+300* (2 zone)
LI Induction cooking module 700+300 (2 zones)*

Misure (LxP) | Measures (WxD)
1000 x 700 mm
Peso | Weight 50 kg

Cod. 1069835.1 - E--

MODULI E KIT CUCINA LARES SERIE INOX

LARES INOX SERIES MODULES AND KITS



MODULI FRIGO | FRIDGE MODULES

Materiali | Materials E

LI Modulo frigo neutro 700*

LI Worktop fridge module 700*

Misure (LxP) | Measures (WxD)
700 x 700 mm

Peso | Weight 70 kg

Cod. 1066514.1 - E--



LI Modulo frigo e cottura a gas 700 (2 fuochi)*

LI Fridge and gas cooking module 700 (2 burners)*

Misure (LxP) | Measures (WxD)
700 x 700 mm

Peso | Weight 75 kg

Cod. 1066516.1 - E--



LI Modulo frigo e cottura a induzione 700 (2 zone)*

LI Fridge and induction cooking module 700 (2 zones)*

Misure (LxP) | Measures (WxD)
700 x 700 mm

Peso | Weight 73 kg

Cod. 1066515.1 - E--



LI Modulo frigo neutro 700+300*

LI Worktop fridge module 700+300*

Misure (LxP) | Measures (WxD)
1000 x 700 mm

Peso | Weight 90 kg

Cod. 1069837.1 - E--



LI Modulo frigo e cottura a gas 700+300 (2 fuochi)*

LI Fridge and gas cooking module 700+300 (2 burners)*

Misure (LxP) | Measures (WxD)
1000 x 700 mm

Peso | Weight 95 kg

Cod. 1069838.1 - E--



LI Modulo frigo e cottura a induzione 700+300 (2 zone)*

LI Fridge and induction cooking module 700+300 (2 zones)*

Misure (LxP) | Measures (WxD)
1000 x 700 mm

Peso | Weight 93 kg

Cod. 1069839.1 - E--



MODULI LAVELLO | SINK MODULES

Materiali | Materials E

LI Modulo lavello 700*

LI Sink module 700*

Misure (LxP) | Measures (WxD)
700 x 700 mm

Peso | Weight 30 kg

Cod. 1063929.0 - E--



LI Modulo lavello 700+300*

LI Sink module 700+300*

Misure (LxP) | Measures (WxD)
1000 x 700 mm

Peso | Weight 55 kg

Cod. 1069836.0 - E--



LI Modulo lavello 1000*

LI Sink module 1000*

Misure (LxP) | Measures (WxD)
1000 x 700 mm

Peso | Weight 40 kg

Cod. 1063924.0 - E--

* Comporre il codice con la variante finitura del piano di lavoro come indicato a pagina 78.

Il codice di vendita indicato è relativo alla certificazione CE dei sistemi di cottura. Per altre certificazioni, riferirsi alla tabella di conversione a pagina 80. Frigo, lavello, piano cottura a gas e a induzione sono installabili sia a sinistra che a destra del modulo.

* Compose the code with the worktop finish variant as indicated on page 78.

The indicated sales code relates to the CE certification of the cooking systems. For other certifications, refer to the conversion table on page 80. Fridge, sink, gas and induction hob can be installed both on the left and on the right of the module.

MODULI E KIT CUCINA LARES SERIE INOX

LARES INOX SERIES MODULES AND KITS



MODULI SUPPORTO | SUPPORT MODULES

Materiali | Materials E

KIT GIUNZIONE* | JUNCTION KIT*

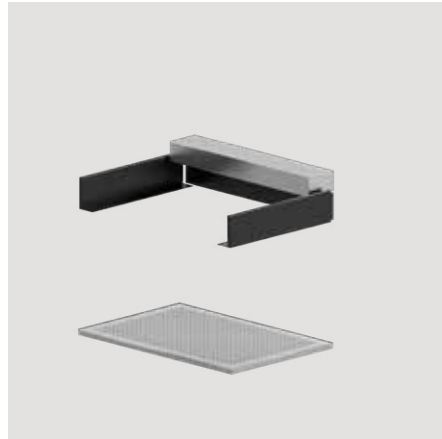

LI Modulo supporto barbecue FGA 500*

LI FGA 500 barbecue support module*

Misure (LxP) | Measures (WxD)

580 x 700 mm

Peso | Weight 13 kg

Cod.1063757.0 - E--



LI Modulo supporto barbecue FGB 250*

LI FGB 250 barbecue support module*

Misure (LxP) | Measures (WxD)

700 x 700 mm

Peso | Weight 32 kg

Cod. 1075327.0 - E--



LI Modulo supporto smoker*

LI Smoker support module*

Misure (LxP) | Measures (WxD)

580 x 700 mm

Peso | Weight 12 kg

Cod. 1068552.0 - E--



LK Modulo supporto caminetto* **

LK Fireplace support module* **

Misure (LxP) | Measures (WxD)

950 x 709 mm

Peso | Weight 9 kg

Cod. 1074639.0

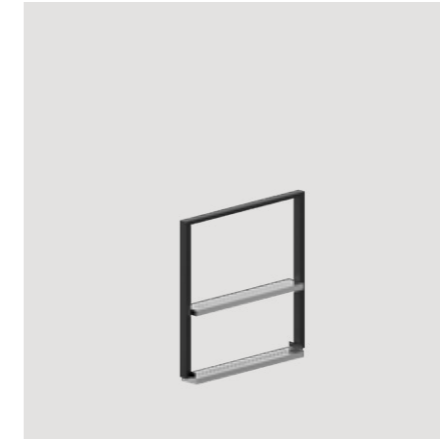

LK Kit giunzione moduli**

LK Modules junction kit**

Peso | Weight 3 kg

Cod. 1063932.0

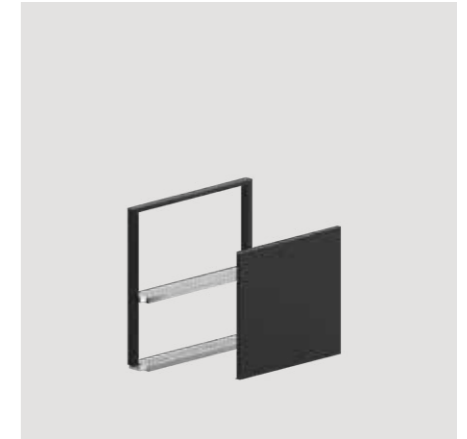

LK Kit giunzione moduli angolo**

LK Corner modules junction kit**

Peso | Weight 4 kg

Cod. 1064484.0

LI Modulo supporto barbecue FGA 750*

LI FGA 750 barbecue support module*

Misure (LxP) | Measures (WxD)

830 x 700 mm

Peso | Weight 16 kg

Cod. 1063549.0 - E--

LI Modulo supporto barbecue FGB 500*

LI FGB 500 barbecue support module*

Misure (LxP) | Measures (WxD)

1000 x 700 mm

Peso | Weight 40 kg

Cod. 1075555.0 - E--

LI Modulo supporto barbecue FGA 1000*

LI FGA 1000 barbecue support module*

Misure (LxP) | Measures (WxD)

1080 x 700 mm

Peso | Weight 18 kg

Cod. 1063705.0 - E--

* Comporre il codice con la variante finitura del piano di lavoro come indicato a pagina 78.

Il codice di vendita indicato è relativo alla certificazione CE dei sistemi di cottura. Per altre certificazioni, riferirsi alla tabella di conversione a pagina 80.

* Compose the code with the worktop finish variant as indicated on page 78.

The indicated sales code relates to the CE certification of the cooking systems. For other certifications, refer to the conversion table on page 80.

** Il kit di giunzione è necessario ogniqualvolta si accostino due moduli autoportanti con gambe.

** The junction kit is necessary whenever two self-supporting modules with legs are placed side by side.

CARENATURE E ACCESSORI

DOORS AND ACCESSORIES



CARENATURE E ACCESSORI | DOORS AND ACCESSORIES

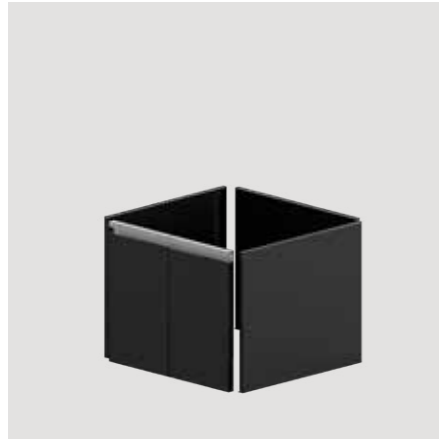

LK Kit carenature modulo 385
LK Doors kit for 385 module

Peso | Weight 8 kg

Cod. 1069738.0

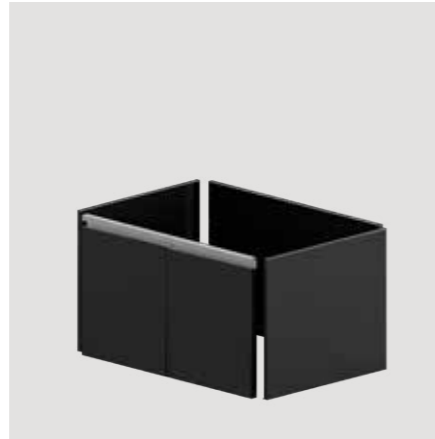

LK Kit carenature barbecue FGA 500
LK Doors kit for FGA 500 barbecue

Peso | Weight 12 kg

Cod. 1069915.0

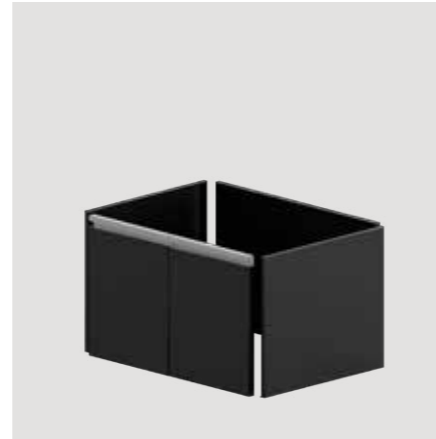

LK Kit carenature caminetto FFP
LK Doors kit for FFP fireplace

Peso | Weight 14 kg

Cod. 1074644.0

LK Kit carenature modulo 700
LK Doors kit for 700 module

Peso | Weight 12 kg

Cod. 1069980.0

LK Kit carenature barbecue FGA 750
LK Doors kit for FGA 750 barbecue

Peso | Weight 15 kg

Cod. 1069982.0

LK Kit carenature modulo 1000
LK Doors kit for 1000 module

Peso | Weight 15 kg

Cod. 1069979.0

LK Kit carenature barbecue FGA 1000
LK Doors kit for FGA 1000 barbecue

Peso | Weight 17 kg

Cod. 1069981.0



CARENATURE E ACCESSORI | DOORS AND ACCESSORIES

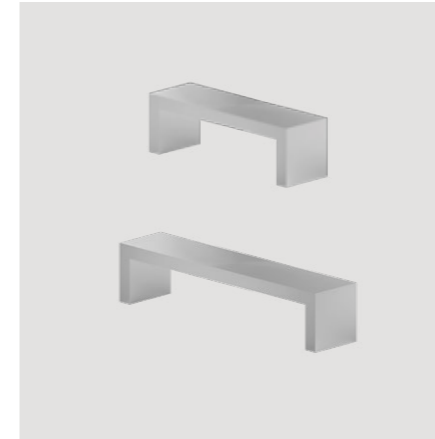

LK Portaspezie 700
LK Spice rack 700

Misure (LxP) | Measures (WxD)
700 x 210 mm
Peso | Weight 3,5 kg

Cod. 1046056.0

LK Portaspezie 1000
LK Spice rack 1000

Misure (LxP) | Measures (WxD)
1000 x 210 mm
Peso | Weight 4,5 kg

Cod. 1042704.0

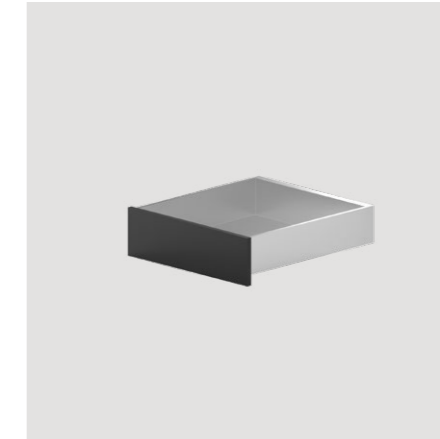

LK Cassetto sotto top modulo 700
LK Under top drawer for 700 module

Peso | Weight 12 kg

Cod. 1074041.0

LK Cassetto sotto top modulo 1000
LK Under top drawer for 1000 module

Peso | Weight 15 kg

Cod. 1070393.0



LK Coperchio piano cottura (2 fuochi)
LK Hot plate cover (2 burners)

Misure (LxP) | Measures (WxD)
555 x 415 mm
Peso | Weight 3 kg

Cod. 1046069.0

CARENATURE E ACCESSORI

DOORS AND ACCESSORIES



CARENATURE E ACCESSORI | DOORS AND ACCESSORIES

**LK Appenderia 2,3 m**

LK Frame 2,3 m

Misure (LxP) | Measures (WxD)

2300 x 660 mm

Peso | Weight 51 kg

Cod. 1047006.0**LK Mensola per appenderia 1000**

LK Shelf for frame 1000

Misure (LxP) | Measures (WxD)

1000 x 221 mm

Peso | Weight 3 kg

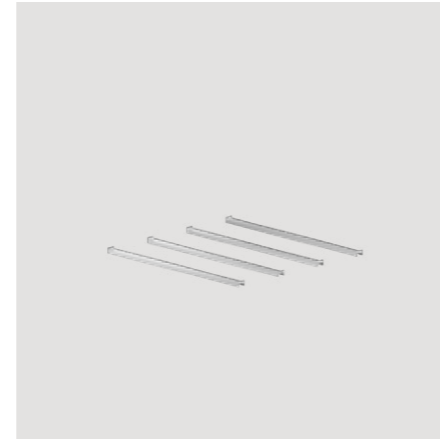
Cod. 1044266.0**LK Kit protezione appenderia**

LK Frame protection kit

Peso | Weight 2,5 kg

Cod. 1047026.0**LK Appenderia 2,6 m**

LK Frame 2,6 m

Misure (LxP) | Measures (WxD)

2600 x 660 mm

Peso | Weight 55 kg

Cod. 1064023.0**LK Appenderia 2,9 m**

LK Frame 2,9 m

Misure (LxP) | Measures (WxD)

2900 x 660 mm

Peso | Weight 60 kg

Cod. 1040120.0

CARENATURE E ACCESSORI | DOORS AND ACCESSORIES

**LK Ripiano intermedio modulo 700**

LK Middle shelf for 700 module

Peso | Weight 5 kg

Cod. 1069912.0**LK Ripiano intermedio modulo 1000 /
Modulo BBQ 750**LK Middle shelf for 1000 module /
BBQ 750 module

Peso | Weight 7,5 kg

Cod. 1069911.0**LK Ripiano intermedio
modulo BBQ 500**LK Middle shelf for
BBQ 500 module

Peso | Weight 5,5 kg

Cod. 1069913.0**LK Ripiano intermedio
modulo BBQ 1000**LK Middle shelf for
BBQ 1000 module

Peso | Weight 9,5 kg

Cod. 1069914.0



MISURE MODULI 85-385-700-1000 mm
MODULES MEASUREMENTS 85-385-700-1000 mm

CUCINA LARES SERIE GRES

LARES GRES SERIES KITCHEN

Le cucine Lares della serie Gres offrono una selezione di finiture per il piano di lavoro sapientemente selezionate dal nostro team di designer. Le differenti finiture consentono di progettare la vostra cucina per ottenere un look personalizzato e perfettamente integrato con lo stile dello spazio circostante.

Lares Gres series kitchens include a range of finishes for the worktops, carefully selected by our design team. Different finishes will help you design your own tailor-made kitchen and combine it with your personal space.



PIANO DI LAVORO IN GRES

STONE WORKING SURFACE

Il piano di lavoro perfetto deve essere esteticamente bello, resistente e facile da pulire, il top in gres è capace di soddisfare tutte e tre le esigenze. Composto da una miscela di materie naturali pressate e cotte ad oltre 1100 gradi, il piano è composto da un'unica lastra iniettata con materiale sintetico alleggerito che ne aumenta la resistenza. Sopporta acqua e calore, è igienico e non rilascia elementi chimici negli alimenti. Questo processo è oggetto di brevetto depositato.

The ideal worktop should be aesthetically pleasing, resistant and easy to clean. Gres worktops can meet all these needs. It is made of a mix of natural materials that are pressed and then cooked at more than 1100°. The top is made from a single plate, injected with lightweight synthetic material that improves its resistance. It is water and heat resistant, hygienic and it does not release any chemicals when cooking. This process has been patented by Føgher.

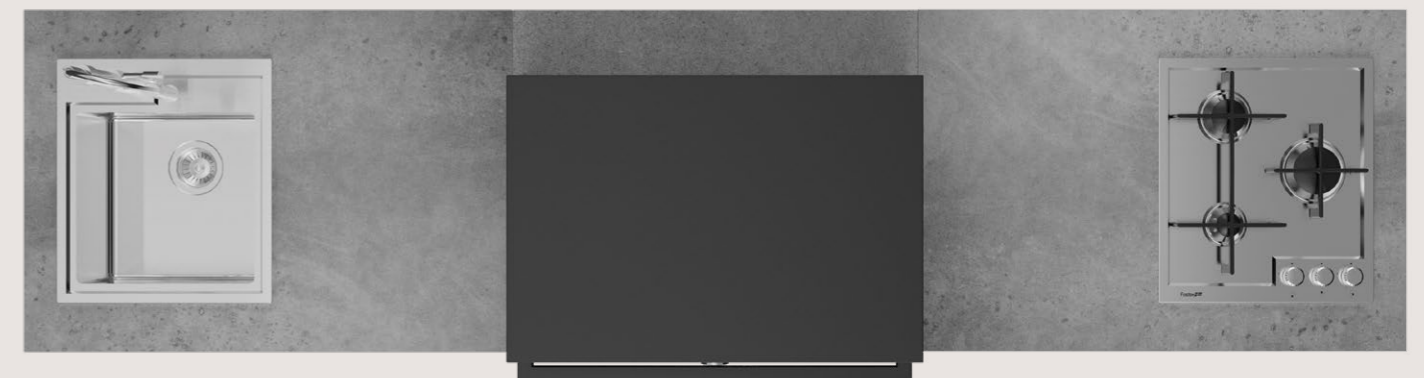

COMPOSIZIONI PREDEFINITE CUCINA LARES SERIE GRES STANDARD CONFIGURATIONS LARES GRES SERIES KITCHEN



SOLUZIONI | SOLUTIONS

Materiali | Materials M

LG Composizione cucina FKC 003*

LG FKC 003 Kitchen configuration*

- Modulo lavello 1000
- Barbecue FGA 750 FO
- Modulo supporto BBQ FGA 750
- Modulo neutro 1000
- Ripiano intermedio modulo 1000
- Appendiera 2.9 m
- Kit manuale cucina Fògher
- Sink module 1000
- Barbecue FGA 750 FO
- FGA 750 barbecue support module
- Worktop module 1000
- Middle shelf for 1000 module
- Frame 2.9 m
- Fògher kitchen manual

Cod. 1061061.1 - M--



LG Composizione cucina FKC 005*

LG FKC 005 Kitchen configuration*

- Modulo lavello 1000
- Barbecue FGA 750 FO
- Modulo supporto BBQ FGA 750
- Kit carenature modulo BBQ 750
- Modulo cottura a gas 1000 (2 fuochi)
- 2 x Kit carenature modulo 1000
- Appendiera 2.9 m
- Kit manuale cucina Fògher
- Sink module 1000
- Barbecue FGA 750 FO
- FGA 750 barbecue support module
- Doors kit for FGA 750 barbecue
- Gas cooking module 1000 (2 burners)
- 2 x Doors kit for 1000 module
- Frame 2.9 m
- Fògher kitchen manual

Cod. 1064022.1 - M--

* Comporre il codice con la variante finitura del piano di lavoro come indicato a pagina 78.

Il codice di vendita indicato è relativo alla certificazione CE dei sistemi di cottura. Per altre certificazioni, riferirsi alla tabella di conversione a pagina 80.

* Compose the code with the worktop finish variant as indicated on page 78.

The indicated sales code relates to the CE certification of the cooking systems. For other certifications, refer to the conversion table on page 80.

SOLUZIONI | SOLUTIONS

Materiali | Materials M**LG Composizione cucina FKC 006***

LG FKC 006 Kitchen configuration*

- Modulo lavello 1000
- Barbecue FGA 1000 FO
- Modulo supporto barbecue FGA 1000
- Kit carenature barbecue FGA 1000
- Modulo cottura a gas 1000 (2 fuochi)
- 2 x Kit carenature modulo 1000
- Kit manuale cucina Fògher

- Sink module 1000
- Barbecue FGA 1000 FO
- FGA 1000 barbecue support module
- Doors kit for FGA 1000 barbecue
- Gas cooking module 1000 (2 burners)
- 2 x Doors kit for 1000 module
- Fògher kitchen manual

Cod. 1076265.1 - M--

**LG Composizione cucina FKC 007***

LG FKC 007 Kitchen configuration*

- Barbecue FGA 750 FO
- Modulo supporto barbecue FGA 750
- Kit carenature barbecue FGA 750
- Modulo cottura gas 1000 (2 fuochi)
- Kit carenature modulo 1000
- Modulo neutro 85
- Kit manuale cucina Fògher

- Barbecue FGA 750 FO
- FGA 750 barbecue support module
- Doors kit for FGA 750 barbecue
- Gas cooking module 1000 (2 burners)
- Doors kit for 1000 module
- Worktop module 85
- Fògher kitchen manual

Cod. 1076266.1 - M--



SOLUZIONI | SOLUTIONS

Materiali | Materials M**LG Composizione cucina FKC 008***

LG FKC 008 Kitchen configuration*

- Barbecue FGA 750 FO
- Modulo supporto barbecue FGA 750
- Kit carenature barbecue FGA 750
- Modulo cottura gas 1000 (2 fuochi)
- Kit carenature modulo 1000
- Modulo neutro 85
- Appendiera 2.0 m
- Kit manuale cucina Fògher

- Barbecue FGA 750 FO
- FGA 750 barbecue support module
- Doors kit for FGA 750 barbecue
- Gas cooking module 1000 (2 burners)
- Doors kit for 1000 module
- Worktop module 85
- Frame 2.0 m
- Fògher kitchen manual

Cod. 1076267.1 - M--

**LG Composizione cucina FKC 009***

LG FKC 009 Kitchen configuration*

- Modulo lavello 700
- Barbecue FGA 500 FO
- Modulo supporto barbecue FGA 500
- Ripiano intermedio modulo BBQ 500
- Modulo neutro 700
- 2 x Kit carenature modulo 700
- Kit manuale cucina Fògher

- Sink module 700
- Barbecue FGA 500 FO
- FGA 500 barbecue support module
- Middle shelf for BBQ 500 module
- Worktop module 700
- 2 x Doors kit for 700 module
- Fògher kitchen manual

Cod. 1076268.1 - M--



* Comporre il codice con la variante finitura del piano di lavoro come indicato a pagina 78.

Il codice di vendita indicato è relativo alla certificazione CE dei sistemi di cottura. Per altre certificazioni, riferirsi alla tabella di conversione a pagina 80.

* Compose the code with the worktop finish variant as indicated on page 78.

The indicated sales code relates to the CE certification of the cooking systems. For other certifications, refer to the conversion table on page 80.

SOLUZIONI | SOLUTIONS

Materiali | Materials M**LG Composizione cucina FKC 010***

LG FKC 010 Kitchen configuration*

- Modulo lavello 1000
- Barbecue FGA 750 FO
- Modulo supporto barbecue FGA 750
- Kit carenature barbecue FGA 750
- Modulo neutro 1000
- 2 x Kit carenature modulo 1000
- Kit manuale cucina Fògher

- Sink module 1000
- Barbecue FGA 750 FO
- FGA 750 barbecue support module
- Doors kit for FGA 750 barbecue
- Worktop module 1000
- 2 x Doors kit for 1000 module
- Fògher kitchen manual

Cod. 1076269.1 - M--

LG Composizione cucina FKC 011*

LG FKC 011 Kitchen configuration*

- Modulo lavello 1000
- Barbecue FGA 750 FO
- Modulo supporto barbecue FGA 750
- Modulo neutro 1000
- Ripiano intermedio modulo 1000
- Kit manuale cucina Fògher

- Sink module 1000
- Barbecue FGA 750 FO
- FGA 750 barbecue support module
- Worktop module 1000
- Middle shelf for 1000 module
- Fògher kitchen manual

Cod. 1076270.1 - M--



SOLUZIONI | SOLUTIONS

Materiali | Materials M**LG Composizione cucina FKC 012***

LG FKC 012 Kitchen configuration*

- Modulo lavello 1000
- Modulo frigo neutro 700
- Modulo cottura a induzione 1000 (2 zone)
- Barbecue FGA 1000 FO
- Modulo supporto barbecue FGA 1000
- Modulo neutro 85
- 2 x Kit giunzione moduli
- 2 x Kit carenature modulo 1000
- Ripiano intermedio modulo BBQ 1000
- Cassetto sotto top modulo 1000
- Kit manuale cucina Fògher

- Sink module 1000
- Worktop fridge module 700
- Induction cooking module 1000 (2 zones)
- Barbecue FGA 1000 FO
- FGA 1000 barbecue support module
- Worktop module 85
- 2 x Modules junction kit
- 2 x Doors kit for 1000 module
- Middle shelf for BBQ 1000 module
- Under top drawer for 1000 module
- Fògher kitchen manual

Cod. 1076271.1 - M--

* Comporre il codice con la variante finitura del piano di lavoro come indicato a pagina 78.

Il codice di vendita indicato è relativo alla certificazione CE dei sistemi di cottura. Per altre certificazioni, riferirsi alla tabella di conversione a pagina 80.

* Compose the code with the worktop finish variant as indicated on page 78.

The indicated sales code relates to the CE certification of the cooking systems. For other certifications, refer to the conversion table on page 80.

**LG Composizione cucina FK013***

LG FK013 Kitchen configuration*

- Caminetto FFP 950
 - Modulo supporto caminetto
 - Modulo neutro 1000
 - Cassetto sotto top modulo 1000
 - Modulo frigo e induzione 700 + 300 (2 zone)
 - Modulo neutro 700+300
 - Kit giunzione angolo
 - Kit carenature modulo 385
 - Barbecue FGA 1000 FO
 - Modulo supporto barbecue FGA 1000
 - Kit carenature barbecue FGA 1000
 - Modulo lavello 1000
 - Kit carenature modulo 1000
 - 2 x Kit giunzione moduli
 - Kit manuale cucina Fògher
-
- 950 FFP Fireplace
 - Fireplace support module
 - Worktop module 1000
 - Under top drawer for 1000 module
 - Fridge and induction module 700 + 300 (2 zones)
 - Worktop module 700+300
 - Corner junction kit
 - Doors kit for 385 module
 - Barbecue FGA 1000 FO
 - FGA 1000 barbecue support module
 - Doors kit for FGA 1000 barbecue
 - Sink module 1000
 - Doors kit for 1000 module
 - 2 x Modules junction kit
 - Fògher kitchen manual

Cod. 1076272.1 - M--

* Comporre il codice con la variante finitura del piano di lavoro come indicato a pagina 78.

Il codice di vendita indicato è relativo alla certificazione CE dei sistemi di cottura. Per altre certificazioni, riferirsi alla tabella di conversione a pagina 80.

* Compose the code with the worktop finish variant as indicated on page 78.

The indicated sales code relates to the CE certification of the cooking systems. For other certifications, refer to the conversion table on page 80.

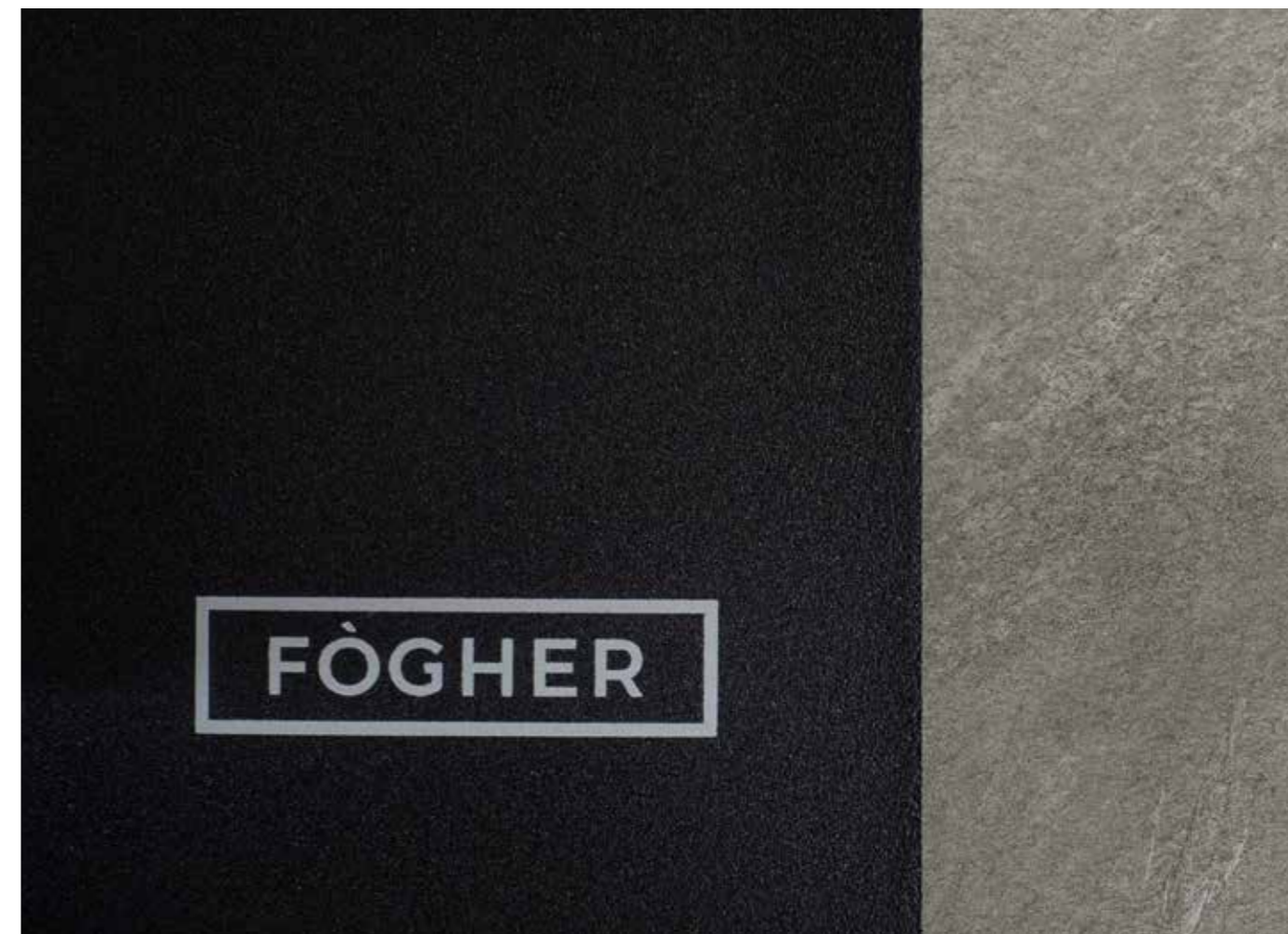

MODULI LARES SERIE GRES

LARES GRES SERIES MODULES

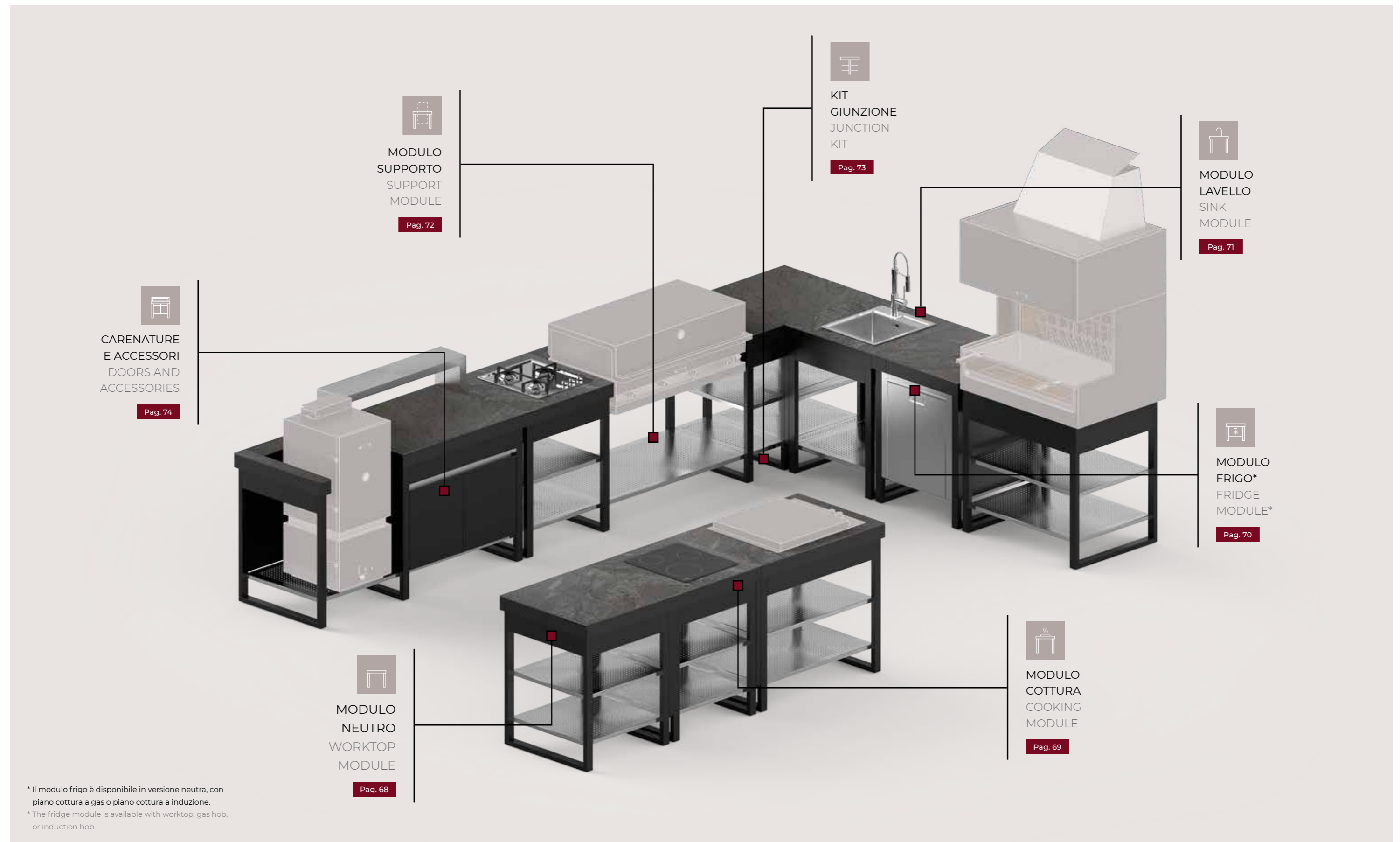

SISTEMI DI COTTURA

COOKING SYSTEMS



BARBECUE A GAS FGA FGA GAS BARBECUE

Modelli compatibili:
Compatible models:

FGA 500
FGA 500 FO
FGA 750
FGA 750 FO
FGA 1000
FGA 1000 FO

Per maggiori informazioni vedere
il capitolo **Barbecue a gas**.
For further information, please see
chapter Gas barbecue.

Pag. 82



SMOKER SMOKER

Modelli compatibili:
Compatible models:

WS 450
RF 450

Per maggiori informazioni
vedere il capitolo **Smoker**.
For further information, please
see chapter Smoker.

Pag. 128



CAMINETTO GRILL OUTDOOR FIREPLACE

Modelli compatibili:
Compatible models:
FFP 950

Per maggiori informazioni vedere
il capitolo **Caminetto Grill**.
For further information, please
see chapter Outdoor fireplace.

Pag. 148



BARBECUE A GAS FGB FGB GAS BARBECUE

Modelli compatibili:
Compatible models:

FGB 250
FGB 500
FGB 500 FO

Per maggiori informazioni vedere
il capitolo **Barbecue a gas**.
For further information, please
see chapter Gas barbecue.

Pag. 82

* Per abaco sistemi di cottura compatibili fare riferimento a pagina 66-67

* For the compatible cooking systems abacus visit page 66-67

SISTEMI DI COTTURA COMPATIBILI CON CUCINE LARES

SISTEMI DI COTTURA | COOKING SYSTEMS



Per maggiori informazioni vedere il capitolo
Barbecue a gas. (pag. 82) | For further information,
please see chapter Gas barbecue. (pag 82)

Barbecue FGA 500*
FGA 500 Barbecue*

Cod. 1072484.1

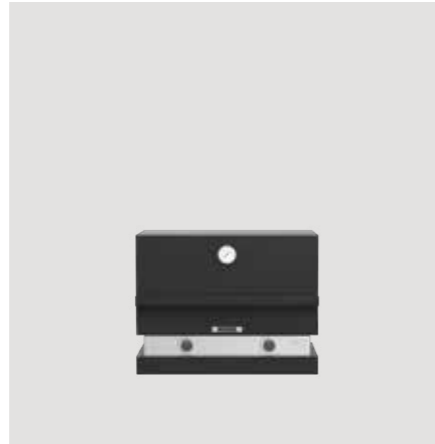

Per maggiori informazioni vedere il capitolo
Barbecue a gas. (pag. 82) | For further information,
please see chapter Gas barbecue. (pag 82)

Barbecue FGA 500 FO*
FGA 500 FO Barbecue*

Cod. 1072485.1



Per maggiori informazioni vedere il capitolo
Barbecue a gas. (pag. 82) | For further information,
please see chapter Gas barbecue. (pag 82)

Barbecue da incasso FGB 250*
Built-in barbecue FGB 250*

Cod. 1071584.1



Per maggiori informazioni vedere il capitolo
Barbecue a gas. (pag. 82) | For further information,
please see chapter Gas barbecue. (pag 82)

Barbecue ad incasso FGB 500 FO*()**
Built-in barbecue FGB 500 FO*(**)

Cod. 1072503.1



Per maggiori informazioni vedere il capitolo
Smoker (pag. 128) | For further information, please
see chapter Smoker. (pag.128)

Smoker WS 450*
WS 450 smoker*

Cod. 1062131.0



Per maggiori informazioni vedere il capitolo
Caminetto Grill. (pag.148) | For further information,
please see chapter Outdoor fireplace. (pag. 148)

Caminetto FFP 950*
950 FFP Fireplace*

Cod. 1077329.0

Barbecue FGA 750*
FGA 750 Barbecue*

Cod. 1070463.1

Barbecue FGA 750 FO*
FGA 750 FO Barbecue*

Cod. 1070493.1

Barbecue da incasso FGB 500*
Built-in barbecue FGB 500*

Cod. 1072502.1

Smoker RF 450*
RF 450 smoker*

Cod. 1075715.0

Barbecue FGA 1000*
FGA 1000 Barbecue*

Cod. 1071440.1

Barbecue FGA 1000 FO*
FGA 1000 FO Barbecue*

Cod. 1071742.1

* Il codice di vendita indicato è relativo alla certificazione CE dei sistemi di cottura. Per altre certificazioni, riferirsi alla tabella di conversione a pagina 80.
* The indicated sales code relates to the CE certification of the cooking systems. For other certifications, refer to the conversion table on page 80.

** Il Barbecue ad incasso FGB 500 FO non può essere posizionato a ridosso di una parete ma deve essere installato su un modulo ad isola.
** The built-in barbecue FGB 500 FO cannot be positioned close to a wall but must be installed on an isle module.

MODULI E KIT CUCINA LARES SERIE GRES

LARES GRES SERIES MODULES AND KITS



MODULI NEUTRI | WORKTOP MODULES

Materiali | Materials M

LG Modulo neutro 85*

LG Worktop module 85*

Misure (LxP) | Measures (WxD)
85 x 700 mm

Peso | Weight 8,5 kg

Cod. 1068488.0 - M--



LG Modulo neutro 385*

LG Worktop module 385*

Misure (LxP) | Measures (WxD)
385 x 700 mm

Peso | Weight 23 kg

Cod. 1069506.0 - M--



LG Modulo neutro 700+300*

LG Worktop module 700+300*

Misure (LxP) | Measures (WxD)
1000 x 700 mm

Peso | Weight 50 kg

Cod. 1069822.0 - M--

LG Modulo neutro 700*

LG Worktop module 700*

Misure (LxP) | Measures (WxD)
700 x 700 mm

Peso | Weight 33 kg

Cod. 1063534.0 - M--

LG Modulo neutro 1000*

LG Worktop module 1000*

Misure (LxP) | Measures (WxD)
1000 x 700 mm

Peso | Weight 42 kg

Cod. 1063487.0 - M--

* Comporre il codice con la variante finitura del piano di lavoro come indicato a pagina 78.

Il codice di vendita indicato è relativo alla certificazione CE dei sistemi di cottura. Per altre certificazioni, riferirsi alla tabella di conversione a pagina 80.

Frigo, lavello, piano cottura a gas e a induzione sono installabili sia a sinistra che a destra del modulo.

* Compose the code with the worktop finish variant as indicated on page 78.

The indicated sales code relates to the CE certification of the cooking systems. For other certifications, refer to the conversion table on page 80.

Fridge, sink, gas and induction hob can be installed both on the left and on the right of the module.



MODULI COTTURA | COOKING MODULES

Materiali | Materials M

LG Modulo cottura gas 700 (3 fuochi)*

LG Gas cooking module 700 (3 burners)*

Misure (LxP) | Measures (WxD)
700 x 700 mm

Peso | Weight 35 kg

Cod. 1077220.1 - M--



LG Modulo cottura induzione 700 (3 zone)*

LG Induction cooking module 700 (3 zones)*

Misure (LxP) | Measures (WxD)
700 x 700 mm

Peso | Weight 33 kg

Cod. 1077222.1 - M--



LG Modulo cottura gas 700+300 (3 fuochi)*

LG Gas cooking module 700+300 (3 burners)*

Misure (LxP) | Measures (WxD)
1000 x 700 mm

Peso | Weight 52 kg

Cod. 1077224.1 - M--

LG Modulo cottura gas 1000 (3 fuochi)*

LG Gas cooking module 1000 (3 burners)*

Misure (LxP) | Measures (WxD)
1000 x 700 mm

Peso | Weight 43 kg

Cod. 1077221.1 - M--

LG Modulo cottura induzione 1000 (3 zone)*

LG Induction cooking module 1000 (3 zones)*

Misure (LxP) | Measures (WxD)
1000 x 700mm

Peso | Weight 41 kg

Cod. 1077223.1 - M--



LG Modulo cottura induzione 700+300 (3 zone)*

LG Induction cooking
module 700+300 (3 zones)*Misure (LxP) | Measures (WxD)
1000 x 700 mm

Peso | Weight 50 kg

Cod. 1077225.1 - M--

MODULI E KIT CUCINA LARES SERIE GRES

LARES GRES SERIES MODULES AND KITS



MODULI FRIGO | FRIDGE MODULES

Materiali | Materials M

LG Modulo frigo neutro 700*

LG Worktop fridge module 700*

Misure (LxP) | Measures (WxD)
700 x 700 mm

Peso | Weight 70 kg

Cod. 1066514.1 - M--



LG Modulo frigo e cottura a gas 700 (3 fuochi)*

LG Fridge and gas cooking module 700 (3 burners)*

Misure (LxP) | Measures (WxD)
700 x 700 mm

Peso | Weight 75 kg

Cod. 1077226.1 - M--



LG Modulo frigo e cottura a induzione 700 (3 zone)*

LG Fridge and induction cooking module 700 (3 zones)*

Misure (LxP) | Measures (WxD)
700 x 700 mm

Peso | Weight 73 kg

Cod. 1077227.1 - M--



LG Modulo frigo neutro 700+300

LG Worktop fridge module 700+300*

Misure (LxP) | Measures (WxD)
1000 x 700 mm

Peso | Weight 90 kg

Cod. 1069837.1 - M--



LG Modulo frigo e cottura a gas 700+300 (3 fuochi)*

LG Fridge and gas cooking module 700+300 (3 burners)*

Misure (LxP) | Measures (WxD)
1000 x 700 mm

Peso | Weight 95 kg

Cod. 1077228.1 - M--



LG Modulo frigo e cottura a induzione 700+300 (3 zone)*

LG Fridge and induction cooking module 700+300 (3 zones)*

Misure (LxP) | Measures (WxD)
1000 x 700 mm

Peso | Weight 93 kg

Cod. 1077229.1 - M--



MODULI LAVELLO | SINK MODULES

Materiali | Materials M

LG Modulo lavello 700*

LG Sink module 700*

Misure (LxP) | Measures (WxD)
700 x 700 mm

Peso | Weight 30 kg

Cod. 1077230.0 - M--



LG Modulo lavello 700+300*

LG Sink module 700+300*

Misure (LxP) | Measures (WxD)
1000 x 700 mm

Peso | Weight 55 kg

Cod. 1077231.1 - M--



LG Modulo lavello 1000*

LG Sink module 1000*

Misure (LxP) | Measures (WxD)
1000 x 700 mm

Peso | Weight 40 kg

Cod. 1077232.1 - M--

* Comporre il codice con la variante finitura del piano di lavoro come indicato a pagina 78.

Il codice di vendita indicato è relativo alla certificazione CE dei sistemi di cottura. Per altre certificazioni, riferirsi alla tabella di conversione a pagina 80. Frigo, lavello, piano cottura a gas e a induzione sono installabili sia a sinistra che a destra del modulo.

* Compose the code with the worktop finish variant as indicated on page 78.

The indicated sales code relates to the CE certification of the cooking systems. For other certifications, refer to the conversion table on page 80.

Fridge, sink, gas and induction hob can be installed both on the left and on the right of the module.

MODULI E KIT CUCINA LARES SERIE GRES

LARES GRES SERIES MODULES AND KITS



MODULI SUPPORTO | SUPPORT MODULES

Materiali | Materials M

LG Modulo supporto barbecue FGA 500*
LG FGA 500 barbecue support module*

Misure (LxP) | Measures (WxD)
580 x 700 mm
Peso | Weight 13 kg

Cod.1063757.0 - M--



LG Modulo supporto barbecue FGB 250*
LG FGB 250 barbecue support module*

Misure (LxP) | Measures (WxD)
700 x 700 mm
Peso | Weight 32 kg

Cod. 1075327.0 - M--



LG Modulo supporto smoker*
LG Smoker support module*

Misure (LxP) | Measures (WxD)
580 x 700 mm
Peso | Weight 12 kg

Cod. 1068552.0 - M--



LK Modulo supporto caminetto*
LK Fireplace support module*

Misure (LxP) | Measures (WxD)
950 x 709 mm
Peso | Weight 30 kg

Cod. 1074639.0 - M--



KIT GIUNZIONE* | JUNCTION KIT*

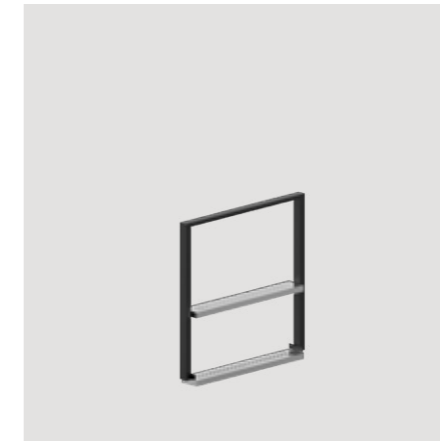

LK Kit giunzione moduli**
LK Modules junction kit**

Peso | Weight 3 kg

Cod. 1063932.0

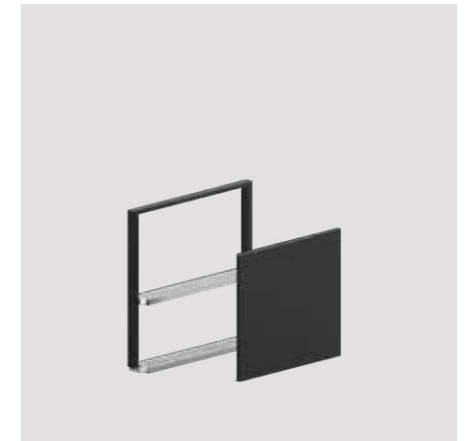

LK Kit giunzione moduli angolo**
LK Corner modules junction kit**

Peso | Weight 4 kg

Cod. 1064484.0

LG Modulo supporto barbecue FGA 750*
LG FGA 750 barbecue support module*

Misure (LxP) | Measures (WxD)
830 x 700 mm
Peso | Weight 16 kg

Cod. 1063549.0 - M--

LG Modulo supporto barbecue FGB 500*
LG FGB 500 barbecue support module*

Misure (LxP) | Measures (WxD)
1000 x 700 mm
Peso | Weight 40 kg

Cod. 1075555.0 - M--

LG Modulo supporto barbecue FGA 1000*
LG FGA 1000 barbecue support module*

Misure (LxP) | Measures (WxD)
1080 x 700 mm
Peso | Weight 18 kg

Cod. 1063705.0 - M--

* Comporre il codice con la variante finitura del piano di lavoro come indicato a pagina 78.

Il codice di vendita indicato è relativo alla certificazione CE dei sistemi di cottura. Per altre certificazioni, riferirsi alla tabella di conversione a pagina 80.

* Compose the code with the worktop finish variant as indicated on page 78.

The indicated sales code relates to the CE certification of the cooking systems. For other certifications, refer to the conversion table on page 80.

** Il kit di giunzione è necessario ogniqualvolta si accostino due moduli autoportanti con gambe.

** The junction kit is necessary whenever two self-supporting modules with legs are placed side by side.

CARENATURE E ACCESSORI

DOORS AND ACCESSORIES



CARENATURE E ACCESSORI | DOORS AND ACCESSORIES

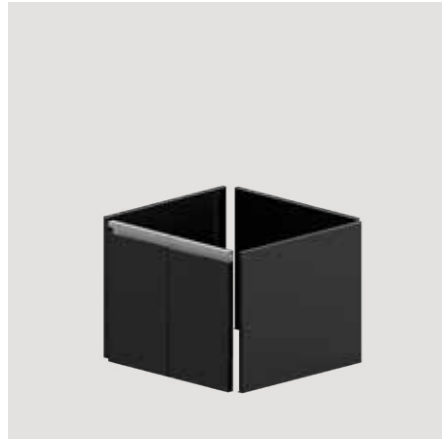

LK Kit carenature modulo 385
LK Doors kit for 385 module

Peso | Weight 8 kg

Cod. 1069738.0

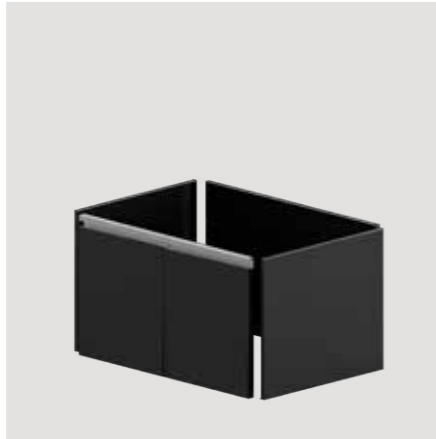

LK Kit carenature barbecue FGA 500
LK Doors kit for FGA 500 barbecue

Peso | Weight 12 kg

Cod. 1069915.0

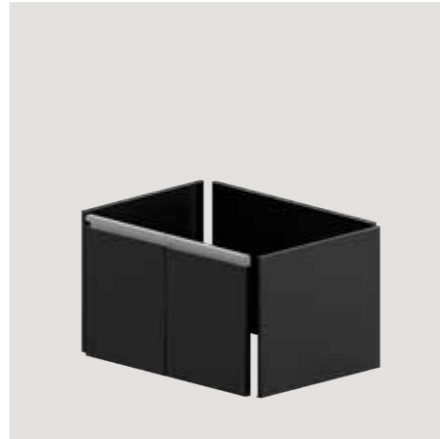

LK Kit carenature caminetto FFP
LK Doors kit for FFP fireplace

Peso | Weight 14 kg

Cod. 1074644.0

LK Kit carenature modulo 700
LK Doors kit for 700 module

Peso | Weight 12 kg

Cod. 1069980.0

LK Kit carenature barbecue FGA 750
LK Doors kit for FGA 750 barbecue

Peso | Weight 15 kg

Cod. 1069982.0

LK Kit carenature modulo 1000
LK Doors kit for 1000 module

Peso | Weight 15 kg

Cod. 1069979.0

LK Kit carenature barbecue FGA 1000
LK Doors kit for FGA 1000 barbecue

Peso | Weight 17 kg

Cod. 1069981.0



CARENATURE E ACCESSORI | DOORS AND ACCESSORIES

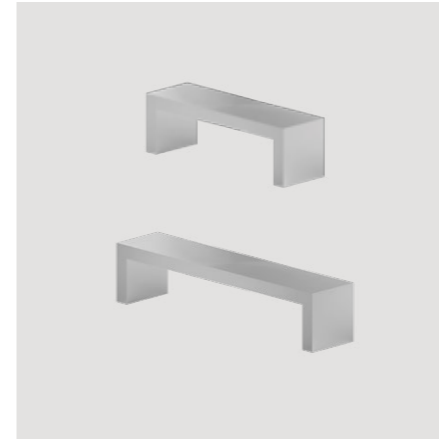

LK Portaspezie 700
LK Spice rack 700

Misure (LxP) | Measures (WxD)
700 x 210 mm
Peso | Weight 3,5 kg

Cod. 1046056.0

LK Portaspezie 1000
LK Spice rack 1000

Misure (LxP) | Measures (WxD)
1000 x 210 mm
Peso | Weight 4,5 kg

Cod. 1042704.0

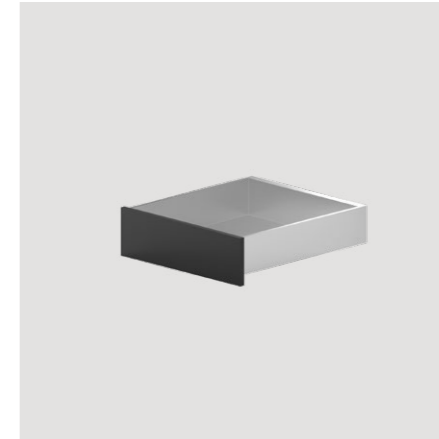

LK Cassetto sotto top modulo 700
LK Under top drawer for 700 module

Peso | Weight 14 kg

Cod. 1074041.0

LK Cassetto sotto top modulo 1000
LK Under top drawer for 1000 module

Peso | Weight 15 kg

Cod. 1070393.0



LK Coperchio piano cottura (3 fuochi)
LK Hot plate cover (3 burners)

Misure (LxP) | Measures (WxD)
555 x 415 mm
Peso | Weight 2,3 kg

Cod. 1077328.0

CARENATURE E ACCESSORI

DOORS AND ACCESSORIES



CARENATURE E ACCESSORI | DOORS AND ACCESSORIES



LK Appenderia 2,3 m

LK Frame 2,3 m

Misure (LxP) | Measures (WxD)

2300 x 660 mm

Peso | Weight 51 kg

Cod. 1047006.0



LK Mensola per appenderia 1000

LK Shelf for frame 1000

Misure (LxP) | Measures (WxD)

1000 x 221 mm

Peso | Weight 3 kg

Cod. 1044266.0

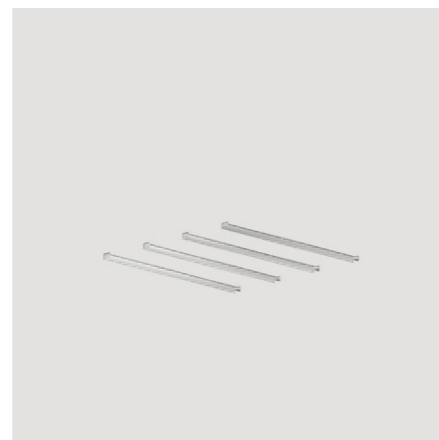

LK Kit protezione appenderia

LK Frame protection kit

Peso | Weight 2,5 kg

Cod. 1047026.0

LK Appenderia 2,6 m

LK Frame 2,6 m

Misure (LxP) | Measures (WxD)

2600 x 660 mm

Peso | Weight 55 kg

Cod. 1064023.0

LK Appenderia 2,9 m

LK Frame 2,9 m

Misure (LxP) | Measures (WxD)

2900 x 660 mm

Peso | Weight 60 kg

Cod. 1040120.0



CARENATURE E ACCESSORI | DOORS AND ACCESSORIES



LK Griglia portapiatti

LK Plate rack

Misure (LxP) | Measures (WxD)

230 x 375 mm

Peso | Weight 2 kg

Cod. 1077321.0



LK Tagliere in noce

LK Walnut cutting board

Misure (LxP) | Measures (WxD)

230 x 366 mm

Peso | Weight 2 kg

Cod. 1077322.0

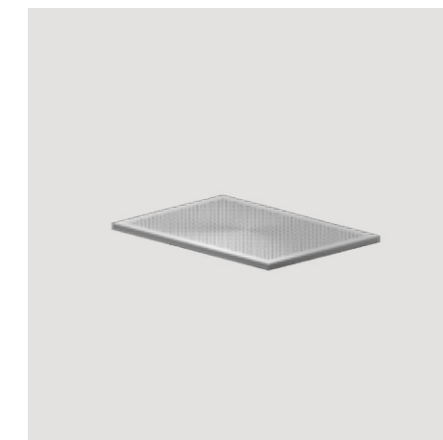

LK Ripiano intermedio modulo 700

LK Middle shelf for 700 module

Peso | Weight 5 kg

Cod. 1069912.0

LK Ripiano intermedio modulo 1000 / Modulo BBQ 750

LK Middle shelf for 1000 module /
BBQ 750 module

Peso | Weight 7,5 kg

Cod. 1069911.0

LK Ripiano intermedio modulo BBQ 500

LK Middle shelf for
BBQ 500 module

Peso | Weight 5,5 kg

Cod. 1069913.0

LK Ripiano intermedio modulo BBQ 1000

LK Middle shelf for
BBQ 1000 module

Peso | Weight 9,5 kg

Cod. 1069914.0

MATERIALI E FINITURE

MATERIALS AND FINISHES

Grazie alle diverse finiture selezionate dal nostro team di designer, è possibile personalizzare le cucine Lares in base alle vostre specifiche esigenze, affinché si adattino ad ogni ambiente e stile.

The different finishes will help you customize each Føgher product according to your needs, environment and situation.

VARIABILI PIANI TOP | WORKTOP OPTIONS

E

ACCIAIO INOX | STAINLESS STEEL



Acciaio inox satinato
Satin stainless steel

E01

M

GRES STANDARD | STANDARD GRES

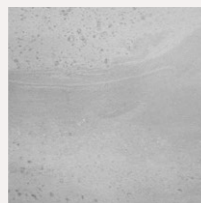

Boreal Pietra Naturale
Boreal Natural Stone

M01



Pacific Gris Bocciardato
Pacific Gris Hammered

M02

COMPOSIZIONE CODICE

CODE COMPOSITION

Ogni codice prodotto al momento dell'ordine deve essere composto da quattro elementi: codice articolo, codice certificazione, codice materiale e codice finitura. La composizione avviene come mostrato di seguito.

Each product code at the time of the order must consist of four elements: article code, certification code, material code and finishing code. The composition is done as shown below.



TABELLA DI CONVERSIONE MODELLI E CERTIFICATI

MODELS AND CERTIFICATIONS CONVERSION CHART

MODELLI MODELS	CE (1)	CE PRO (2)	UL (3)
LI COMPOSIZIONE CUCINA FKC 001 LI KITCHEN CONFIGURATION FKC 001	1061059.1	-	-
LI COMPOSIZIONE CUCINA FKC 002 LI KITCHEN CONFIGURATION FKC 002	1061060.1	-	-
LI COMPOSIZIONE CUCINA FKC 004 LI KITCHEN CONFIGURATION FKC 004	1064021.1	-	-
LI COMPOSIZIONE CUCINA FKC 0020 LI KITCHEN CONFIGURATION 020	1076933.1	-	-
LI COMPOSIZIONE CUCINA FKC 021 LI KITCHEN CONFIGURATION 021	1076934.1	-	-
LI COMPOSIZIONE CUCINA FKC 022 LI KITCHEN CONFIGURATION 022	1076935.1	-	-
LI COMPOSIZIONE CUCINA FKC 023 LI KITCHEN CONFIGURATION FKC 023	1076936.1	-	-
LI COMPOSIZIONE CUCINA FKC 024 LI KITCHEN CONFIGURATION FKC 024	1076937.1	-	-
LI COMPOSIZIONE CUCINA FKC 025 LI KITCHEN CONFIGURATION FKC 025	1076938.1	-	-
LI COMPOSIZIONE CUCINA FKC 026 LI KITCHEN CONFIGURATION FKC 026	1076939.1	-	-
LG COMPOSIZIONE CUCINA FKC 003 LG KITCHEN CONFIGURATION FKC 003	1061061.1	-	-
LG COMPOSIZIONE CUCINA FKC 005 LG KITCHEN CONFIGURATION FKC 005	1064022.1	-	-
LG COMPOSIZIONE CUCINA FKC 006 LG KITCHEN CONFIGURATION FKC 006	1076265.1	-	-
LG COMPOSIZIONE CUCINA 007 LG KITCHEN CONFIGURATION FKC 007	1076266.1	-	-
LG COMPOSIZIONE CUCINA FKC 008 LG KITCHEN CONFIGURATION FKC 008	1076267.1	-	-
LG COMPOSIZIONE CUCINA FKC 009 LG KITCHEN CONFIGURATION FKC 009	1076268.1	-	-
LG COMPOSIZIONE CUCINA FKC 010 LG KITCHEN CONFIGURATION FKC 010	1076269.1	-	-
LG COMPOSIZIONE CUCINA FKC 011 LG KITCHEN CONFIGURATION FKC 011	1076270.1	-	-
LG COMPOSIZIONE CUCINA FKC 012 LG KITCHEN CONFIGURATION FKC 012	1076271.1	-	-
LG COMPOSIZIONE CUCINA FKC 013 LG KITCHEN CONFIGURATION FKC 013	1076272.1	-	-
LI MODULO COTTURA GAS 700 (2 FUOCHI) LI GAS COOKING MODULE 700 (2 BURNERS)	1063930.1	1063930.1	-
LI MODULO COTTURA GAS 1000 (2 FUOCHI) LI GAS COOKING MODULE 1000 (2 BURNERS)	1063925.1	1063925.1	-
LI MODULO COTTURA INDUZIONE 700 (2 ZONE) LI INDUCTION COOKING MODULE 700 (2 ZONES)	1063931.1	1063931.1	-
LI MODULO COTTURA INDUZIONE 1000 (2 ZONE) LI INDUCTION COOKING MODULE 1000 (2 ZONES)	1063926.1	1063926.1	-
LI MODULO COTTURA GAS 700+300 (2 FUOCHI) LI GAS COOKING MODULE 700+300 (2 BURNERS)	1069834.1	1069834.1	-
LI MODULO COTTURA INDUZIONE 700+300 (2 ZONE) LI INDUCTIO COOKING MODULE 700+300 (2 ZONES)	1069835.1	1069835.1	-
LG MODULO COTTURA GAS 700 (3 FUOCHI) LG GAS COOKING MODULE 700 (3 BURNERS)	1077220.1	1077220.1	-
LG MODULO COTTURA GAS 1000 (3 FUOCHI) LG GAS COOKING MODULE 1000 (3 BURNERS)	1077221.1	1077221.1	-

MODELLI MODELS	CE (1)	CE PRO (2)	UL (3)
LG MODULO COTTURA INDUZIONE 700 (3 ZONE) LG INDUCTION COOKING MODULE 700 (3 ZONES)	1077222.1	1077222.1	-
LG MODULO COTTURA INDUZIONE 1000 (3 ZONE) LG INDUCTION COOKING MODULE 1000 (3 ZONES)	1077223.1	1077223.1	-
LG MODULO COTTURA GAS 700+300 (3 FUOCHI) LG GAS COOKING MODULE 700+300 (3 BURNERS)	1077224.1	1077224.1	-
LG MODULO COTTURA INDUZIONE 700+300 (3 ZONE) LG INDUCTION COOKING MODULE 700+300 (3 ZONES)	1077225.1	1077225.1	-
LI MODULO FRIGO NEUTRO 700 LI WORKTOP FRIDGE MODULE 700	1066514.1	1066514.1	1066514.3
LG MODULO FRIGO NEUTRO 700 LG WORKTOP FRIDGE MODULE 700	1066514.1	1066514.1	1066514.3
LI MODULO FRIGO E COTTURA A GAS 700 (2 FUOCHI) LI FRIDGE AND GAS COOKING MODULE 700 (2 BURNERS)	1066516.1	1066516.1	-
LI MODULO FRIGO E COTTURA A INDUZIONE 700 (2 ZONE) LI FRIDGE AND INDUCTION COOKING MODULE 700 (2 ZONES)	1066515.1	1066515.1	-
LI MODULO FRIGO NEUTRO 700+300 LI WORKTOP FRIDGE MODULE 700+300	1069837.1	1069837.1	1069837.3
LG MODULO FRIGO NEUTRO 700+300 LG WORKTOP FRIDGE MODULE 700+300	1069837.1	1069837.1	1069837.3
LI MODULO FRIGO E COTT. A GAS 700+300 (2 FUOCHI) LI FRIDGE AND GAS COOKING MODULE 700+300 (2 BURNERS)	1069838.1	1069838.1	-
LI MODULO FRIGO E COTT. INDUZ. E 700+300 (2 ZONE) LI FRIDGE AND IND. COOKING MODULE 700+300 (2 ZONES)	1069839.1	1069839.1	-
LG MODULO FRIGO E COTTURA A GAS 700 (3 FUOCHI) LG FRIDGE AND GAS COOKING MODULE 700 (3 BURNERS)	1077226.1	1077226.1	-
LG MODULO FRIGO E COTTURA A INDUZIONE 700 (3 ZONE) LG FRIDGE AND INDUCTION COOKING MODULE 700 (3 ZONES)	1077227.1	1077227.1	-
LG MODULO FRIGO E COTT. A GAS 700+300 (3 FUOCHI) LG FRIDGE AND GAS COOKING MODULE 700+300 (3 BURNERS)	1077228.1	1077228.1	-
LG MODULO FRIGO E COTT. INDUZ. 700+300 (3 ZONE) LG FRIDGE AND IND. COOKING MODULE 799+300 (3 ZONES)	1077229.1	1077229.1	-
BARBECUE FGA 500	1072484.1	1072484.2	1072484.3
BARBECUE FGA 500 FO	1072485.1	1072485.2	1072485.3
BARBECUE FGA 750	1070463.1	1070463.2	1070463.3
BARBECUE FGA 750 FO	1070493.1	1070493.2	1070493.3
BARBECUE FGA 1000	1071440.1	1071440.2	1071440.3
BARBECUE FGA 1000 FO	1071742.1	1071742.2	1071742.3
BARBECUE FGB 250	1071584.1	1071584.2	1071584.3
BARBECUE FGB 500	1072502.1	1072502.2	1072502.3
BARBECUE FGB 500 FO	1072503.1	1072503.2	1072503.3

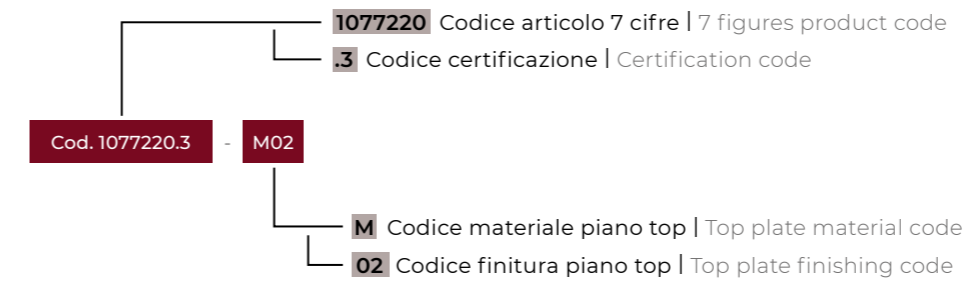
(1) CE = prodotti certificati per uso esterno rispondente alla normativa "EN 498 - UE 2016/426" (valido anche per il mercato UK).

(1) CE = products certified for outdoor use in compliance with the "EN 498 - EU 2016/426" standard (also valid for the UK market).

(2) PRO = prodotti certificati CE per uso professionale/interno rispondente alla normativa "EN 203-1-2014" (valido anche per il mercato UK).

(2) PRO = CE certified products for professional/indoor use in compliance with the "EN 203-1-2014" standard (also valid for the UK market).

(3) UL = prodotti certificati per USA e Canada rispondente alla normativa "Z21.58 2018 / CSA 1.6 2018".

(3) UL = certified products for USA and Canada in compliance with the regulation "Z21.58 2018 / CSA 1.6 2018".

BARBECUE A GAS

GAS BARBECUE



METODI DI COTTURA

COOKING METHODS

Crediamo che in cucina ogni persona debba poter esprimere al massimo la propria creatività, perciò vogliamo dare la possibilità al cuoco, professionista e non, di esprimersi e creare senza limiti. Con i barbecue a gas Fògher è possibile preparare i cibi con diversi tipi di cottura: diretta o indiretta, ad alta e bassa temperatura.

We believe that in the kitchen every person has to be able to express his creativity to the maximum, so we want to give the cook, professional and non-professional, the possibility to experiment and create without limits, for this reason with Fògher gas BBQs it is possible to prepare foods with different types of cooking: direct or indirect, high and low temperature.



COTTURA DIRETTA DIRECT COOKING

BARBECUE BARBECUE



ACCESSORI DI COTTURA COOKING ACCESSORIES

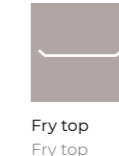

COTTURA INDIRETTA A MEDIA E ALTA TEMPERATURA MEDIUM AND HIGH TEMPERATURE INDIRECT COOKING

BARBECUE BARBECUE



ACCESSORI DI COTTURA COOKING ACCESSORIES

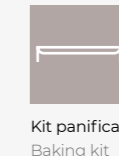
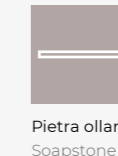
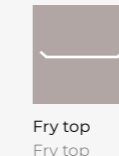

COTTURA INDIRETTA A BASSA TEMPERATURA E AFFUMICATURA LOW TEMPERATURE INDIRECT COOKING AND SMOKING

BARBECUE BARBECUE

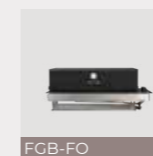

ACCESSORI DI COTTURA COOKING ACCESSORIES

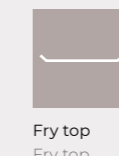



COTTURA DIRETTA DIRECT COOKING

La cottura diretta è la classica grigliata in cui il cibo è a diretto contatto con la fonte di calore, con questo tipo di cottura si raggiungono temperature molto alte che permettono di cucinare velocemente diverse tipologie di pietanze, come carne, pesce e verdure.

Direct cooking is the classic way of grilling where food comes into direct contact with the heat source. In this way you can reach high temperatures which allow you to cook very quickly different types of dishes, such as meat, fish and vegetables.

BARBECUE | BARBECUE



ACCESSORI DI COTTURA | COOKING ACCESSORIES



CIBI | DISHES





COTTURA INDIRETTA A MEDIA E ALTA TEMPERATURA MEDIUM AND HIGH TEMPERATURE INDIRECT COOKING

Nella cottura indiretta il cibo non è a diretto contatto con la fonte di calore, ma quest'ultimo viene riflesso dal coperchio coibentato all'interno della camera di cottura, trasformando il barbecue in un vero e proprio forno. Questo tipo di cottura richiede tempi più lunghi, ma consente di cucinare alimenti anche di grandi dimensioni, come arrostiti, pollame e dolci.

With indirect cooking food doesn't come into direct contact with the heat source. On the contrary, heat is reflected by the insulated lid inside of the cooking chamber, transforming the barbecue into an actual oven. This method of cooking requires considerable times, but it also allows you to cook large-sized food, such as roasted meat, chicken and to bake.

BARBECUE | BARBECUE



ACCESSORI DI COTTURA | COOKING ACCESSORIES



CIBI | DISHES





COTTURA INDIRETTA A BASSA TEMPERATURA - AFFUMICATURA

LOW TEMPERATURE INDIRECT COOKING - SMOKING

La cottura indiretta a bassa temperatura utilizza il coperchio come sistema di riflessione del calore ma sfrutta una temperatura più bassa all'interno della camera di cottura, è così possibile cucinare qualsiasi alimento, anche di grandi dimensioni o che richiede lunghe cotture. Inoltre attraverso l'apposito kit vi è la possibilità di aggiungere alle pietanze una nota affumicata grazie all'uso di chips di legni aromatici.

Low temperature indirect cooking involves the use of the lid as a heat reflection system, while using a lower temperature inside of the cooking chamber. In this way you can cook any type of food, also large-sized ones and the ones requiring long cooking. With the dedicated kit, you will be given the option to add a smoky taste to your dishes thanks to the chips of aromatic wood.

BARBECUE | BARBECUE

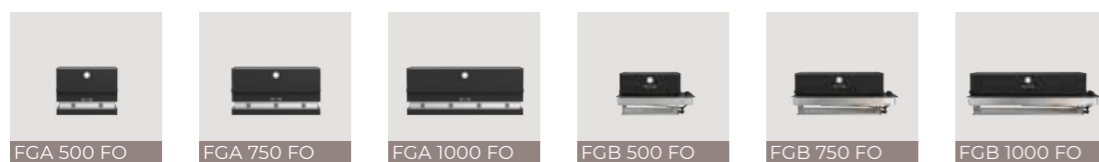

ACCESSORI DI COTTURA | COOKING ACCESSORIES



CIBI | DISHES



IL BARBECUE IN DETTAGLIO

THE BARBECUE IN DETAIL

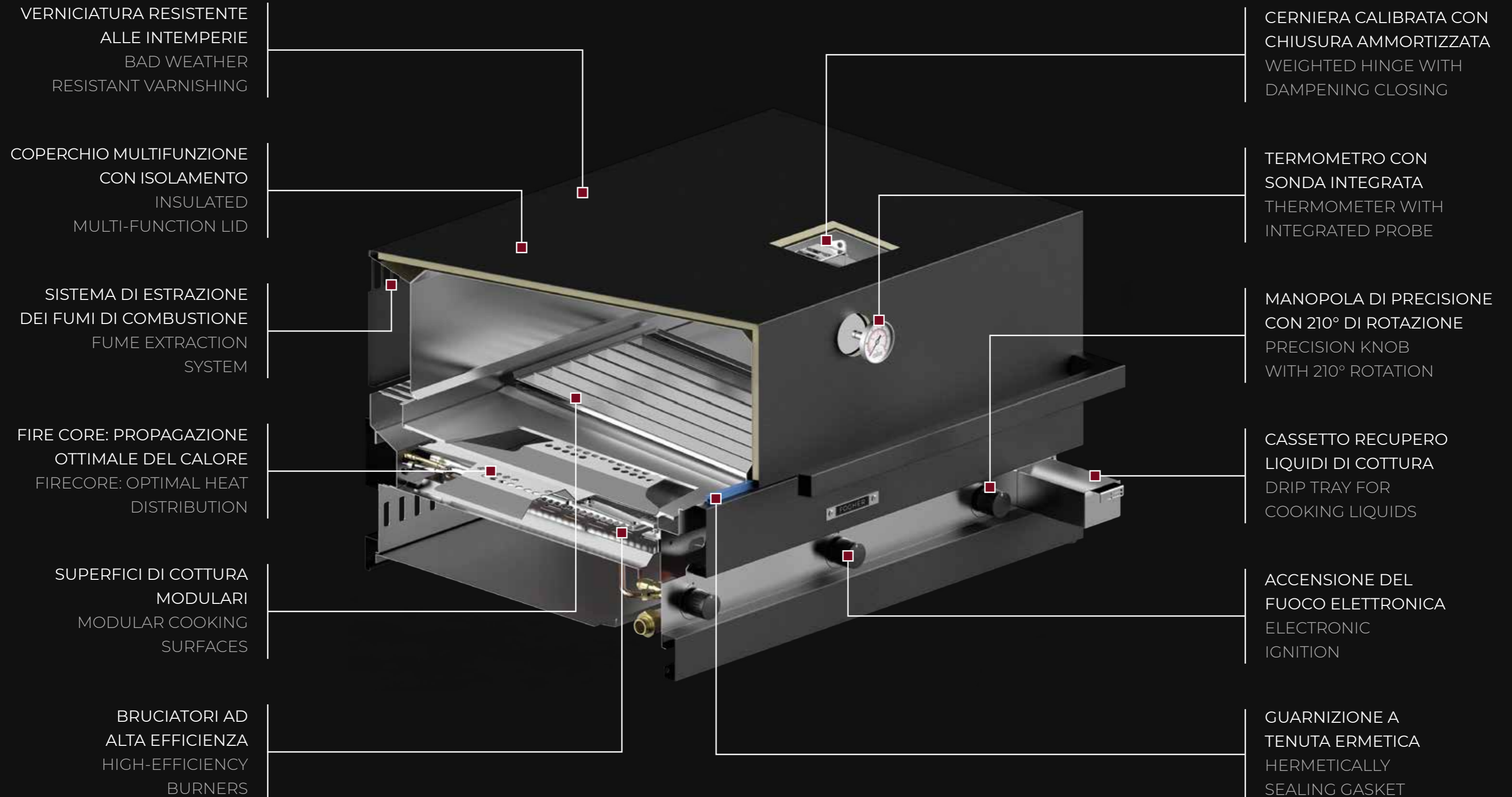

DETTAGLI TECNICI

Sono i dettagli a rendere i barbecue a gas Fògher così speciali, una moltitudine di caratteristiche tecniche pensate e studiate appositamente per migliorare l'esperienza durante l'utilizzo. Abbiamo voluto creare uno strumento di cottura "user friendly" di altissima qualità per permettere all'utilizzatore di concentrarsi esclusivamente su ciò che è realmente importante: l'esperienza culinaria.



VERNICIATURA RESISTENTE ALLE INTEMPERIE BAD WEATHER RESISTANT VARNISHING

Grazie alla verniciatura a polveri epossidiche termoindurenti e alla struttura in acciaio, i barbecue Fògher garantiscono una straordinaria resistenza alle alte temperature e agli eventi atmosferici, anche con il passare del tempo.

Thanks to the thermosetting epoxy powders and the steel structure, Fògher's barbecues guarantee an extraordinary resistance to high temperatures and bad weather conditions over time.



BRUCIATORI AD ALTA EFFICIENZA HIGH EFFICIENCY BURNERS

I bruciatori ad alte prestazioni con termocoppie di sicurezza native all'interno della struttura possono funzionare sia a GPL, sia a metano. Grazie all'efficiente sistema di propagazione del calore, i bruciatori riescono ad ottenere una potenza eccezionale con un risparmio di oltre 50% di gas rispetto ai competitors (2,5kW rispetto a 6kW).

High-performance burners with native thermocouples inside of the structure run both on LPG and methane gas. Thanks to the efficient heat distribution system, burners guarantee exceptional power while saving more than 50% of the gas comparing to competitors (2,5kW vs 6kW).

TECHNICAL DETAILS

Details are what makes Fògher's gas barbecues so special, a multitude of technical features designed specially to improve the cooking experience. We wanted to create a user-friendly yet high-quality cooking tool to let the user concentrate purely on what is actually important: the culinary experience.



FIRECORE®: PROPAGAZIONE OTTIMALE DEL CALORE FIRECORE®: OPTIMAL HEAT DISTRIBUTION

La caratteristica principale dei barbecue a gas Fògher è il sistema Fire Core®. Questo esclusivo sistema di parabole radianti ottimizza il trasferimento di calore dal bruciatore alla piastra, distribuendolo in maniera uniforme su tutta la superficie di cottura. Ciò permette di cucinare con un notevole risparmio energetico.

The core feature of Fògher's gas barbecues is the so-called Fire Core® system. This extraordinary system of radiant paraboles, that help the heat transfer from the burner to the top by distributing it evenly all over the cooking surface, allows you to cook with a considerable saving in energy.



CASSETTO RECUPERO LIQUIDI DI COTTURA DRIP TRAY FOR COOKING LIQUIDS

Attraverso il nostro sistema di raccolta dei liquidi di cottura non sarà più necessario preoccuparsi dello sporco, infatti in ogni barbecue a gas Fògher è presente un pratico contenitore asportabile per la raccolta dei liquidi di colatura. In alternativa è possibile il montaggio di uno scarico per la raccolta direttamente negli appositi contenitori.

Thanks to our system for collecting cooking liquids you no longer have to worry about dirt. Fògher's gas barbecues include a functional extractable tray to collect dripping cooking liquids. In alternative, an exhaust system is available to collect directly the liquids and to transfer them into specific containers.

“Sono i dettagli a rendere i barbecue a gas Fògher così speciali, una moltitudine di caratteristiche tecniche pensate e studiate appositamente per migliorare l’esperienza durante l’utilizzo.”

“Details are what makes Fògher’s gas barbecues so special, a multitude of technical features designed specially to improve the cooking experience.”



MANOPOLA DI PRECISIONE CON 210° DI ROTAZIONE PRECISION KNOB WITH 210° ROTATION

Con 210° di rotazione, rispetto ai 180° standard, le manopole di regolazione dei BBQ Fògher garantiscono una precisione ed un controllo della temperatura eccezionale, l’ideale anche per gli chef più esigenti.

Fògher barbecues’ knobs with 210° of rotation, rather than traditional 180°, guarantee precision and exceptional temperature control, even for demanding chefs.



SUPERFICI DI COTTURA MODULARI MODULAR COOKING SURFACES

Grazie al sistema modulare le superfici di cottura dei BBQ sono intercambiabili e componibili a piacimento, infatti è possibile scegliere tra diversi complementi di cottura in base alle proprie esigenze. Tutte le piastre garantiscono inoltre uno scolo totale del grasso evitando la ricaduta nell’area dei bruciatori e mantenendo le superfici pulite per una cottura più salutare e una facile pulizia di tutti i componenti.

Thanks to the modular system, each barbecue’s cooking surface is interchangeable. You can choose between different cooking tools according to your needs. Each top guarantees total dripping of fat, avoiding it to fall on the burners area and keeping the surfaces clean to guarantee a healthy cooking method and easy cleaning of each component.



TERMOMETRO CON SONDA INTEGRATA THERMOMETER WITH INTEGRATED PROBE

I barbecue della serie FGA-FO sono dotati di un termometro analogico con sonda integrata nel coperchio per permettere una supervisione totale durante la cottura dei cibi.

Barbecues from FGA-FO line are equipped with an analogue thermometer with integrated probe on the lid to allow complete monitoring of food while cooking.



COPERCHIO MULTIFUNZIONE CON ISOLAMENTO INSULATED MULTI-FUNCTION LID

Il coperchio termo isolato “cold cover” dei modelli FGA-FO è un vero e proprio strumento di cottura in grado di trasformare il barbecue in un forno. Questo sistema unito alla guarnizione permette una cottura con temperature eccezionalmente stabili garantendo anche una maggiore sicurezza durante l’utilizzo.

The so-called “cold cover” thermally insulated lid from the FGA-FO line is a real cooking tool able to transform the barbecue into an oven. This system, also thanks to the gasket, allows cooking at extraordinary stable temperatures, while guaranteeing safety in use.

Tutti gli articoli vivono di un design innovativo e ricercato, fatto di forme minimali, volumi spigolosi e richiami geometrici. Una macchina per cucinare, realizzata utilizzando le migliori tecnologie di progettazione, che al contempo risulta un oggetto estremamente raffinato e di tendenza. Un design Made in Italy, come la nostra produzione, che nasce dalla collaborazione appassionata con l'architetto Nicola De Pellegrini.

All of the articles have an innovative and sophisticated design, made of minimal shapes, sharp edged and geometrical patterns. A cooking machine, realized by using the best design technology, but representing at the same time a refined and trendy object. A Made in Italy design, just like our production, that arises from the passionate collaboration with the architect Nicola De Pellegrini.

SISTEMA DI ESTRAZIONE DEI FUMI DI COMBUSTIONE FUME EXTRACTION SYSTEM

L'innovativo sistema brevettato di estrazione dei fumi consente una cottura più salubre e genuina, eliminando i gas di combustione dalla camera di cottura attraverso il camino posizionato nella parte posteriore del coperchio.

The innovative fume extraction patented system allows to cook in a healthier way, eliminating the combustion gases from the cooking chamber through the chimney on the back of the lid.

GUARNIZIONE A TENUTA ERMETICA HERMETICALLY SEALING GASKET

Grazie alla guarnizione resistente alle alte temperature è possibile sigillare ermeticamente la camera di cottura, permettendo così una tenuta del calore e una stabilità delle temperature eccezionale, evitando inoltre che i fumi di cottura e affumicatura escano verso l'utente.

Thanks to the high-temperature resistant gasket the cooking chamber will be hermetically sealed, guaranteeing exceptionally stable heat and temperatures, while avoiding the cooking smoke to come out.

CERNIERA CALIBRATA CON CHIUSURA AMMORTIZZATA WEIGHTED HINGE WITH DAMPENING SYSTEM

L'apertura e chiusura del coperchio è resa estremamente agile grazie alla speciale cerniera calibrata. Grazie alle molle il peso percepito per alzare e abbassare il coperchio sarà di soli 500 g. Ciò, unito alla guarnizione, rende la chiusura leggera e ammortizzata.

Opening and closing the lid will be extremely easy thanks to the weighted hinge. Thanks to the springs the perceived weight will be around 500 g while raising and lowering the lid. This, together with the gasket, makes the close softer and amortized.

ACCENSIONE DEL FUOCO ELETTRONICA ELECTRONIC IGNITION

Il sistema di accensione e gestione dei fuochi consente un'agevole accensione del gas grazie al sistema elettronico integrato.

The ignition and burners management system enables an easy gas ignition thanks to the built-in electronic system.





BARBECUE PER COTTURA DIRETTA
BARBECUE FOR DIRECT COOKING

BARBECUE FGA

FGA BARBECUE

Il barbecue a gas FGA è uno strumento semplice ed efficace per la cottura diretta degli alimenti. È disponibile in diverse misure, con un diverso numero di fuochi e può essere facilmente integrato con numerosi accessori, funzionali e di cottura.

The FGA gas barbecue is a simple and effective tool for direct cooking. It is available in different sizes, with a diverse number of burners and it can easily be integrated with various accessories, functional and intended for different cooking methods.



FGA 500*

Misure (LxP) | Measures (WxD) 551 x 520 mm
Peso | Weight 23,5 kg

Cod. 1072484.1

ACCESSORI DI COTTURA INCLUSI
INCLUDED COOKING ACCESSORIES



Fry top
Fry top



Griglia doppia
Double grill



FGA 750*

Misure (LxP) | Measures (WxD) 800 x 520 mm
Peso | Weight 33 kg

Cod. 1070463.1

ACCESSORI DI COTTURA INCLUSI
INCLUDED COOKING ACCESSORIES



Fry top
Fry top



Griglia doppia
Double grill



FGA 1000*

Misure (LxP) | Measures (WxD) 1051 x 520 mm
Peso | Weight 41 kg

Cod. 1071440.1

ACCESSORI DI COTTURA INCLUSI
INCLUDED COOKING ACCESSORIES



Fry top
Fry top



Griglia doppia
Double grill



* Il codice di vendita indicato è relativo alla certificazione CE dei sistemi di cottura. Per altre certificazioni, riferirsi alla tabella di conversione a pagina 124.

* The indicated sales code relates to the CE certification of the cooking systems. For other certifications, refer to the conversion table on page 124.

COMPOSIZIONI PREDEFINITE

BARBECUE FGA

FGA BARBECUE

STANDARD CONFIGURATIONS



SOLUZIONI | SOLUTIONS



Barbecue FGA 500 con gambe tubolari FKS 001*
FGA 500 barbecue with tubular legs FKS 001*

Misure (LxP) | Measures (WxD): 551 x 520 mm
Peso | Weight 32,5 kg

Cod. 1076476.1

ACCESSORI DI COTTURA INCLUSI
INCLUDED COOKING ACCESSORIES



Fry top
Fry top



Griglia doppia
Double grill



Barbecue FGA 750 con gambe tubolari FKS 002*
FGA 750 barbecue with tubular legs FKS 002*

Misure (LxP) | Measures (WxD): 800 x 520 mm
Peso | Weight 42,5 kg

Cod. 1076477.1

ACCESSORI DI COTTURA INCLUSI
INCLUDED COOKING ACCESSORIES



Fry top
Fry top



Griglia doppia
Double grill



BARBECUE PER COTTURA DIRETTA E INDIRECTA
BARBECUE FOR DIRECT AND INDIRECT COOKING

BARBECUE FGA-FO

FGA-FO BARBECUE

Il barbecue a gas FGA-FO è uno strumento di cottura formidabile grazie alle sue altissime prestazioni e alle sue numerose funzionalità. Il coperchio multifunzione, unito alla completa modularità delle superfici di cottura, rende il barbecue una vera e propria macchina professionale, con cui è possibile affrontare qualsiasi ricetta, dalle più semplici alle più complesse. È disponibile in diverse misure ed è possibile completarlo con diversi accessori.

The FGA-FO gas barbecue is a formidable cooking tool thanks to its high-performing skills and variety of functionalities. The multifunctional lid, together with the full modularity of cooking surfaces, makes the barbecue a real professional machine with which you will be able to face any recipe, from easy to complex ones. It is available in different sizes and it is possible to add diverse accessories.



FGA 500 FO*

Misure (LxP) | Measures (WxD): 551 x 590 mm
Peso | Weight 31,5 kg

Cod. 1072485.1

ACCESSORI DI COTTURA INCLUSI
INCLUDED COOKING ACCESSORIES



Fry top
Fry top



Griglia doppia
Double grill



FGA 750 FO*

Misure (LxP) | Measures (WxD): 800 x 590 mm
Peso | Weight 43 kg

Cod. 1070493.1

ACCESSORI DI COTTURA INCLUSI
INCLUDED COOKING ACCESSORIES



Fry top
Fry top



Griglia doppia
Double grill

Griglia doppia
Double grill



FGA 1000 FO*

Misure (LxP) | Measures (WxD): 1051 x 590 mm
Peso | Weight 53,5 kg

Cod. 1071742.1

ACCESSORI DI COTTURA INCLUSI
INCLUDED COOKING ACCESSORIES



Fry top
Fry top



Griglia doppia
Double grill

Griglia doppia
Double grill

* Il codice di vendita indicato è relativo alla certificazione CE dei sistemi di cottura. Per altre certificazioni, riferirsi alla tabella di conversione a pagina 124.

* The indicated sales code relates to the CE certification of the cooking systems. For other certifications, refer to the conversion table on page 124.

COMPOSIZIONI PREDEFINITE

BARBECUE FGA-FO

FGA-FO BARBECUE

STANDARD CONFIGURATIONS



SOLUZIONI | SOLUTIONS



Barbecue FGA 500 FO con gambe tubolari FKS 003*

FGA 500 FO barbecue with tubular legs FKS 003*

Misure (LxP) | Measures (WxD): 551 x 590 mm

Peso | Weight 40,5 kg

Cod. 1076478.1

ACCESSORI DI COTTURA INCLUSI
INCLUDED COOKING ACCESSORIES



Fry top
Fry top



Griglia doppia
Double grill



Barbecue FGA 750 FO con gambe tubolari FKS 005*

FGA 750 FO barbecue with tubular legs FKS 005*

Misure (LxP) | Measures (WxD): 800 x 590 mm

Peso | Weight 52,5 kg

Cod. 1076480.1

ACCESSORI DI COTTURA INCLUSI
INCLUDED COOKING ACCESSORIES



Fry top
Fry top



Griglia doppia
Double grill

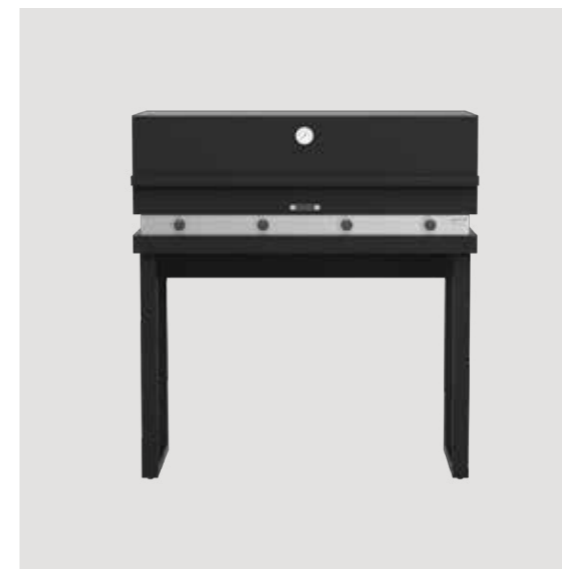

Barbecue FGA 1000 FO con gambe tubolari FKS 007*

FGA 1000 FO barbecue with tubular legs FKS 007*

Misure (LxP) | Measures (WxD): 1051 x 590 mm

Peso | Weight 63 kg

Cod. 1076482.1

ACCESSORI DI COTTURA INCLUSI
INCLUDED COOKING ACCESSORIES



Fry top
Fry top



Griglia doppia
Double grill



* Il codice di vendita indicato è relativo alla certificazione CE dei sistemi di cottura. Per altre certificazioni, riferirsi alla tabella di conversione a pagina 124.

* The indicated sales code relates to the CE certification of the cooking systems. For other certifications, refer to the conversion table on page 124.

SOLUZIONI | SOLUTIONS



Barbecue FGA 500 FO con carrello carenato, con 2 piani laterali FKS 004*
 FGA 500 FO barbecue with cart, doors and 2 side shelves FKS 004*

Misure (LxP) | Measures (WxD): 1050 x 590 mm
 Peso | Weight 57,5 kg

Cod. 1076479.1

ACCESSORI DI COTTURA INCLUSI
 INCLUDED COOKING ACCESSORIES



Fry top
 Fry top



Griglia doppia
 Double grill



Barbecue FGA 750 FO con carrello carenato, con 2 piani laterali FKS 006*
 FGA 750 FO barbecue with cart, doors and 2 side shelves FKS 006*

Misure (LxP) | Measures (WxD): 1300 x 590 mm
 Peso | Weight 73,5 kg

Cod.1076481.1

ACCESSORI DI COTTURA INCLUSI
 INCLUDED COOKING ACCESSORIES



Fry top
 Fry top



Fry top
 Fry top



Griglia doppia
 Double grill



Barbecue FGA 1000 FO con carrello carenato, con 2 piani laterali FKS 008*
 FGA 1000 FO barbecue with cart, doors and 2 side shelves FKS 008*

Misure (LxP) | Measures (WxD): 1551 x 590 mm
 Peso | Weight 88 kg

Cod.1076483.1

ACCESSORI DI COTTURA INCLUSI
 INCLUDED COOKING ACCESSORIES



Fry top
 Fry top



Fry top
 Fry top



Griglia doppia
 Double grill



Griglia doppia
 Double grill

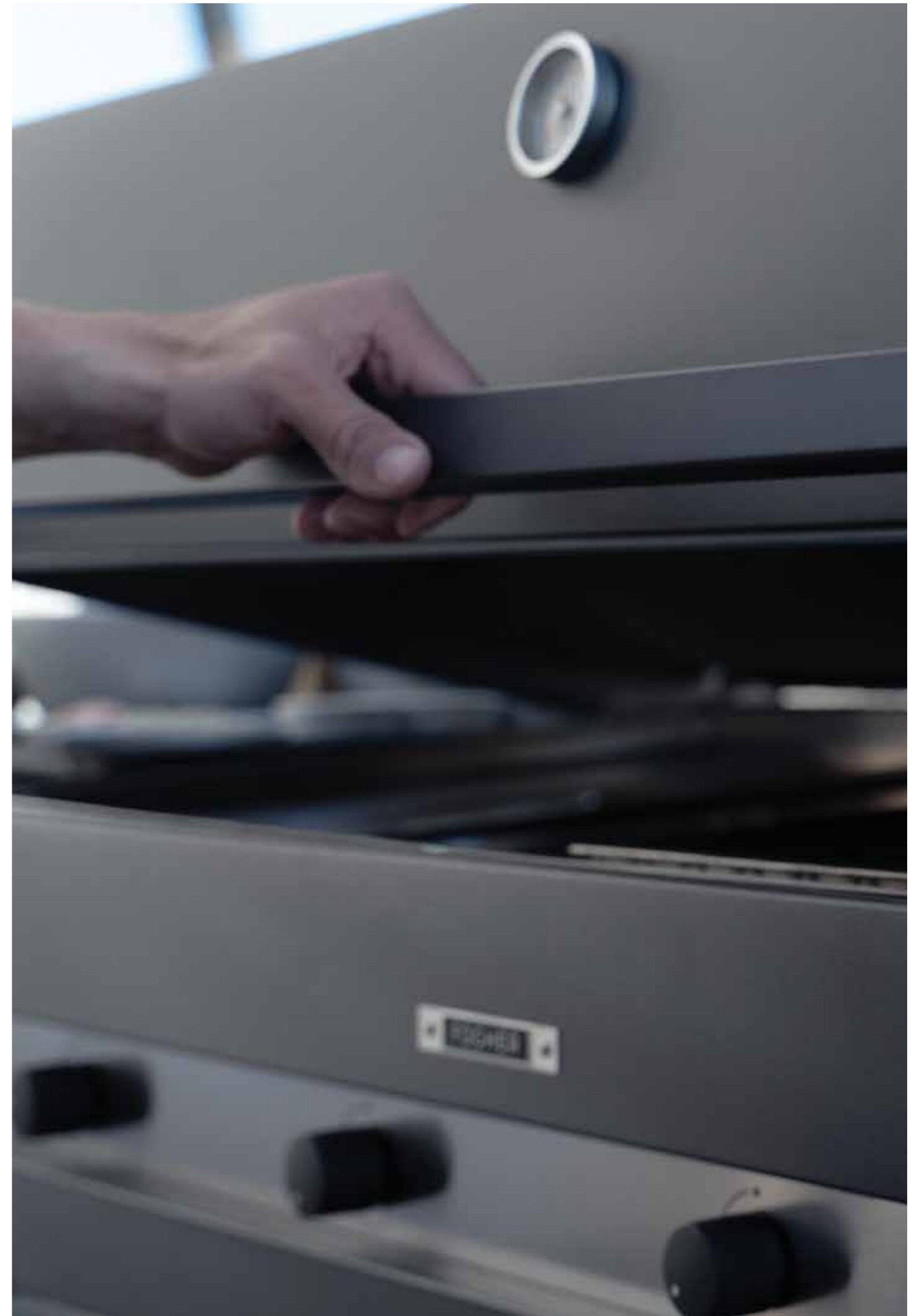

* Il codice di vendita indicato è relativo alla certificazione CE dei sistemi di cottura. Per altre certificazioni, riferirsi alla tabella di conversione a pagina 124.

* The indicated sales code relates to the CE certification of the cooking systems. For other certifications, refer to the conversion table on page 124.

ACCESSORI FUNZIONALI PER FGA E FGA-FO

FGA AND FGA-FO FUNCTIONAL ACCESSORIES

GAMBE, CARRELLO E CARENATURE | LEGS, CART AND DOORS

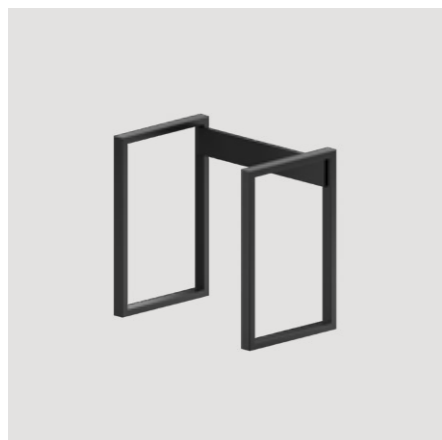

Gambe tubolari fisse 500
Fixed tubular legs 500

Misure (LxP) | Measures (WxD)
532 x 479 mm
Peso | Weight 9 kg

Cod. 1070065.0



Kit carrello leggero 500 sx/dx
Cart BBQ 500 l/r

Misure (LxP) | Measures (WxD)
791 x 508 mm
Peso | Weight 15 kg

Cod. 1070098.0



Kit carenatura gambe/carrello 500
Doors kit for legs/cart BBQ 500

Peso | Weight 8,5 kg

Cod. 1070115.0

Gambe tubolari fisse 750
Fixed tubular legs 750

Misure (LxP) | Measures (WxD)
782 x 479 mm
Peso | Weight 9,5 kg

Cod. 1070066.0

Kit carrello leggero 750 sx/dx
Cart BBQ 750 l/r

Misure (LxP) | Measures (WxD)
1041 x 508 mm
Peso | Weight 16,5 kg

Cod. 1070104.0

Kit carenatura gambe/carrello 750
Doors kit for legs/cart BBQ 750

Peso | Weight 11,5 kg

Cod. 1070116.0

Gambe tubolari fisse 1000
Fixed tubular legs 1000

Misure (LxP) | Measures (WxD)
1033 x 479 mm
Peso | Weight: 9,5 kg

Cod. 1070067.0

Kit carrello leggero 1000 sx/dx
Cart BBQ 1000 l/r

Misure (LxP) | Measures (WxD)
1292 x 508 mm
Peso | Weight 18 kg

Cod. 1070105.0

Kit carenatura gambe/carrello 1000
Doors kit for legs/cart BBQ 1000

Peso | Weight 14 kg

Cod. 1070117.0

Gambe, carrelli, carenature e composizioni vengono forniti in scatola, disassemblati e vanno montati dal cliente.

Legs, carts, doors and configurations are supplied in boxes, dismantled, and should be assembled by the customer.

RIPIANI INFERIORI, LATERALI E COPERTURE | LOWER AND SIDE SHELVING AND COVERINGS

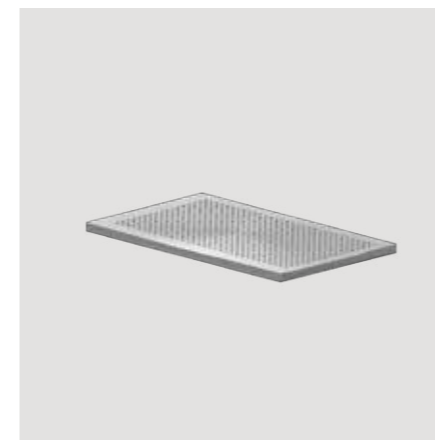

Ripiano gambe/carrello 500
Shelf for legs/cart 500

Misure (LxP) | Measures (WxD)
479 x 414 mm
Peso | Weight 3 kg

Cod. 1070094.0



Pianetto laterale gambe/carrello
Side shelf cart/legs

Misure (LxP) | Measures (WxD)
259 x 508 mm
Peso | Weight 2,5 kg

Cod. 1068113.0

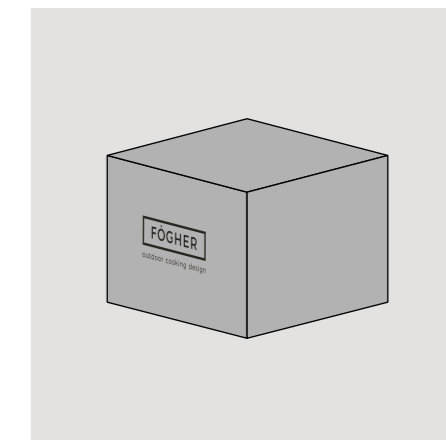

Copertura in tessuto impermeabile
Waterproof textile cover

Copertura per FGA 500
Cover for FGA 500

Cod. 1076919.0

Copertura per FGA 500 FO
Cover for FGA 500 FO

Cod. 1076920.0

Copertura per FGA 750
Cover for FGA 750

Cod. 1076921.0

Copertura per FGA 750 FO
Cover for FGA 750 FO

Cod. 1076922.0

Copertura per FGA 1000
Cover for FGA 1000

Cod. 1076923.0

Copertura per FGA 1000 FO
Cover for FGA 1000 FO

Cod. 1076924.0

Ripiano gambe/carrello 750
Shelf for legs/cart 750

Misure (LxP) | Measures (WxD)
730 x 414 mm
Peso | Weight 4 kg

Cod. 1070095.0

Ripiano gambe/carrello 1000
Shelf for legs/cart 1000

Misure (LxP) | Measures (WxD)
980 x 414 mm
Peso | Weight: 5,5 kg

Cod. 1070096.0



BARBECUE PER COTTURA DIRETTA
BARBECUE FOR DIRECT COOKING

BARBECUE AD INCASSO FGB

BUILT-IN FGB BARBECUE

Il modello di barbecue FGB è pensato per l'installazione su piani di lavoro preesistenti senza alcun compromesso in termini di qualità e prestazioni rispetto ai modelli standard. Inoltre i barbecue ad incasso Fògher sono studiati in modo tale da evitare l'eccessivo riscaldamento dei piani in cui vengono installati preservandoli così da eventuali danni dovuti al calore.

The FGB barbecue has been designed to be installed on pre-existing surfaces with no compromises in terms of quality and performances when compared to the standard models. Fògher's built-in barbecues are developed to avoid the supporting surfaces to overheat, preserving them from potential damages caused by the heat.

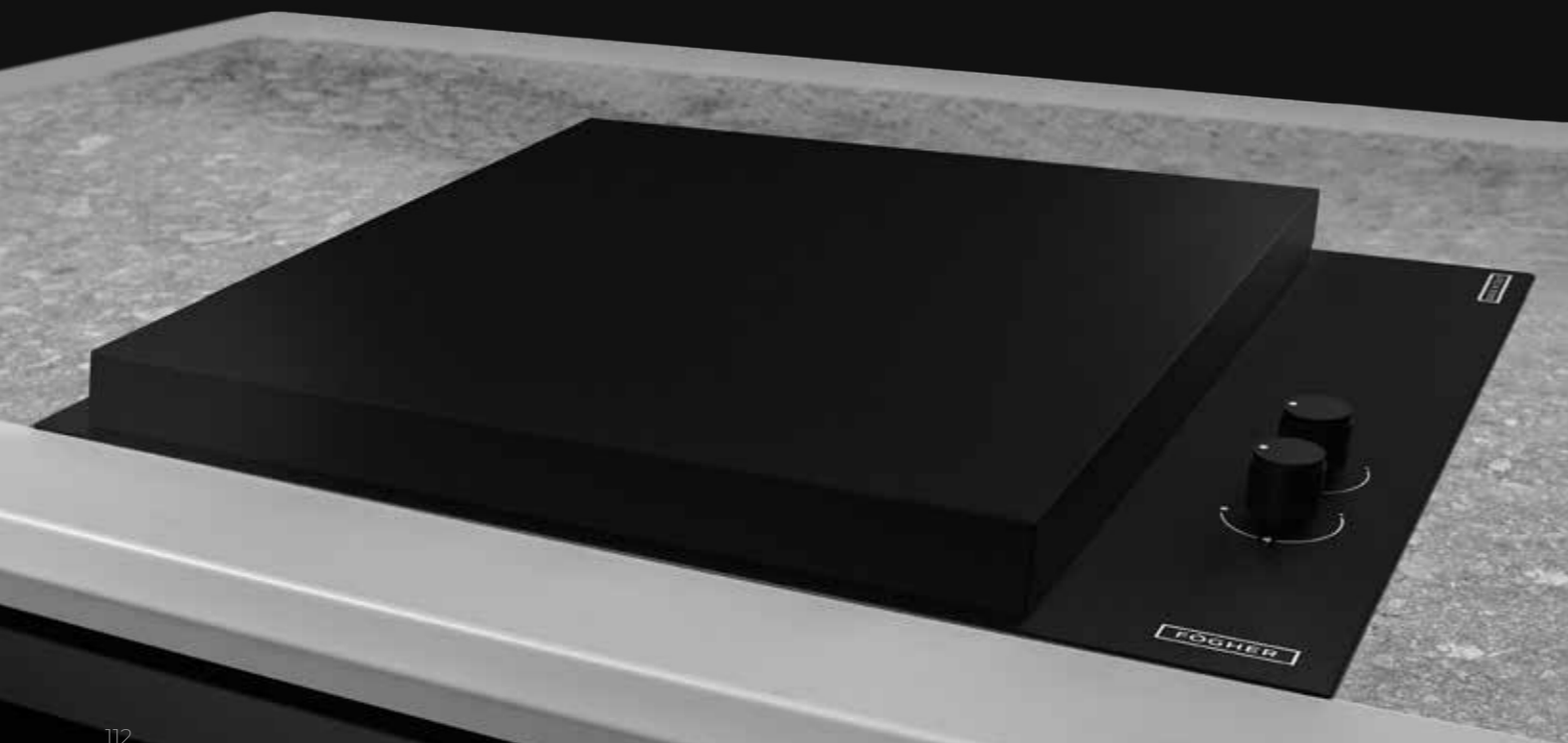

FGB 250*

Misure (LxP) | Measures (WxD): 462 x 575 mm
Peso | Weight 17 kg

Cod. 1071584.1

ACCESSORI DI COTTURA INCLUSI
INCLUDED COOKING ACCESSORIES



Fry top
Fry top



FGB 500*

Misure (LxP) | Measures (WxD): 712 x 575 mm
Peso | Weight 25 kg

Cod. 1072502.1

ACCESSORI DI COTTURA INCLUSI
INCLUDED COOKING ACCESSORIES



Fry top
Fry top



Griglia doppia
Double grill



FGB 750*

Misure (LxP) | Measures (WxD): 963 x 575 mm
Peso | Weight 35 kg

Cod. 1070852.1

ACCESSORI DI COTTURA INCLUSI
INCLUDED COOKING ACCESSORIES



Fry top
Fry top



Griglia doppia
Double grill



FGB 1000*

Misure (LxP) | Measures (WxD): 1213 x 575 mm
Peso | Weight 43 kg

Cod. 1072504.1

ACCESSORI DI COTTURA INCLUSI
INCLUDED COOKING ACCESSORIES



Fry top
Fry top



Griglia doppia
Double grill

* Il codice di vendita indicato è relativo alla certificazione CE dei sistemi di cottura. Per altre certificazioni, riferirsi alla tabella di conversione a pagina 124.

* The indicated sales code relates to the CE certification of the cooking systems. For other certifications, refer to the conversion table on page 124.



BARBECUE PER COTTURA DIRETTA E INDIRETTA
BARBECUE FOR DIRECT AND INDIRECT COOKING

BARBECUE AD INCASSO FGB-FO

BUILT-IN FGB-FO BARBECUE

Uno strumento di cottura eccezionale che attraverso il suo particolare coperchio multifunzione permette di trasformare il barbecue in un vero e proprio forno consentendo così di cucinare una moltitudine di cibi. Questo modello è installabile su diversi piani di lavoro, infatti grazie ad un attento studio dei materiali si è potuto evitare il surriscaldamento del piano in cui viene collocato e quindi possibili deformazioni dei materiali.

An exceptional cooking machine capable of transforming the barbecue into a real oven thanks to the multifunctional lid, allowing you to cook a multitude of dishes. This model can be installed on diverse surfaces. Careful studies on materials have made it possible to avoid the supporting surface to overheat and the materials to be deformed.



FGB 500 FO*

Misure (LxP) | Measures (WxD): 712 x 615 mm
Peso | Weight 33 kg

Cod. 1072503.1

ACCESSORI DI COTTURA INCLUSI
INCLUDED COOKING ACCESSORIES



Fry top
Fry top



Griglia doppia
Double grill



FGB 750 FO*

Misure (LxP) | Measures (WxD): 963 x 615 mm
Peso | Weight 45 kg

Cod. 1071761.1

ACCESSORI DI COTTURA INCLUSI
INCLUDED COOKING ACCESSORIES



Fry top
Fry top



Griglia doppia
Double grill



FGB 1000 FO*

Misure (LxP) | Measures (WxD): 1213 x 615 mm
Peso | Weight 55 kg

Cod. 1071551.1

ACCESSORI DI COTTURA INCLUSI
INCLUDED COOKING ACCESSORIES



Fry top
Fry top



Griglia doppia
Double grill



* Il codice di vendita indicato è relativo alla certificazione CE dei sistemi di cottura. Per altre certificazioni, riferirsi alla tabella di conversione a pagina 124.

* The indicated sales code relates to the CE certification of the cooking systems. For other certifications, refer to the conversion table on page 124.

BARBECUE FGB: PENSATO PER INTEGRARSI

FGB BARBECUE: READY FOR INTEGRATION

Grazie al particolare studio sui materiali e dei flussi d'aria relativi al barbecue ad incasso abbiamo sviluppato un prodotto in grado di mantenere prestazioni identiche ad un barbecue tradizionale ma che al contempo riesce ad essere delicato con le superfici che lo supportano.

Thanks to the specific studies of materials and air flow we carried out on built-in barbecues, we developed a product that is able to guarantee the same benefits as a traditional barbecue, while being gently fused with the supporting surface.

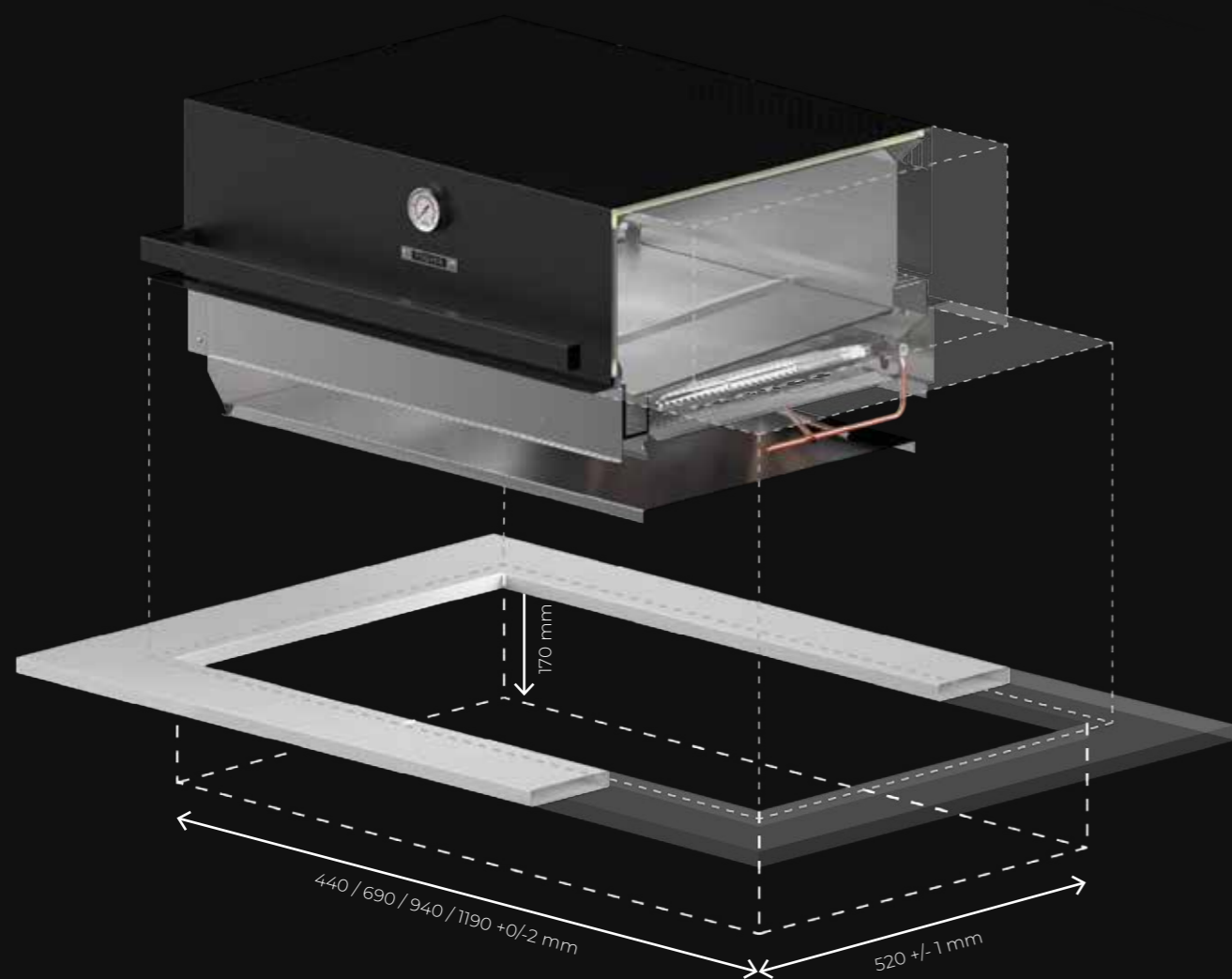

I piani di supporto su cui è possibile installare il barbecue sono molteplici e realizzati in diversi materiali:

- Pietra
- Metallo
- MFC

There's a variety of supporting surfaces, made of diverse materials, where to install the barbecues:

- Stone
- Metal
- MFC



Non solo oggetti di design, ma veri e propri strumenti dalle grandi qualità tecniche, 100% realizzati in Italia. Grazie all'innovativa struttura, agli accessori e alle regolazioni del sistema FIRE CORE®, sarete voi a decidere la modalità, la temperatura e la tecnica di cottura che desiderate adottare, sia indoor che outdoor, infatti il BBQ è certificato con il marchio di sicurezza UL, per uso esterno, interno e professionale.

Not just design objects but real tools of great technical qualities, 100% made in Italy. Thanks to the innovative frame, the accessories and the adjustments of the FIRE CORE® system, you decide the operation mode, temperature and cooking technique both indoor and outdoor; the BBQ is indeed certified with the UL safety mark for internal, external and professional use.



ACCESSORI DI COTTURA

Gli accessori di cottura sono uno degli elementi più importanti, in quanto sono le uniche superfici a diretto contatto con gli alimenti e per questo motivo selezioniamo accuratamente i materiali e le lavorazioni necessarie per la loro realizzazione.



FRY TOP IN ACCIAIO STEEL FRY TOP

Realizzata in acciaio AISI 430 priva di saldature, questa superficie di cottura ha un'ottima performance. Dato lo spessore riesce a mantenere il calore stabile e più a lungo limitando il consumo di gas, inoltre è sagomata per permettere lo scolo dei liquidi di cottura.

This AISI 430 steel top without any soldering shows an outstanding performance. Thanks to its thickness, the heat is stable for a longer time and gas waste is prevented. Its shape has been specifically designed to allow cooking liquids to drain.



GRIGLIA DOPPIA IN ACCIAIO DOUBLE STEEL GRILL

Una griglia ad estrazione totale scomponibile per facilitare la pulizia. La sua particolare struttura frangi fiamma garantisce una cottura con temperature corrette evitando che le fiamme entrino in contatto diretto con il cibo, eliminando così ogni tipo di bruciatura.

An extractable grill, which can be totally decomposed to facilitate cleaning. The particular structure of its flame breakers allows cooking at stable temperatures, avoiding the flames to get into direct contact with food and consequently preventing burnings.

COOKING ACCESSORIES

Cooking accessories are one of the most important features, being the only surfaces that come into direct contact with food. That's why we carefully select the materials and treatments that are necessary to produce them.



PIETRA OLLARE SOAPSTONE

Una piastra di pietra ollare spessa 20 mm perfetta per la cottura della carne e che permette di cucinare senza l'aggiunta di grassi come olio o burro.

A soapstone grilling surface, 20 mm thickness, ideal for cooking meat, that allows cooking without the addition of fats, such as oil or butter.



KIT COTTURA INDIRETTA E AFFUMICATURA INDIRECT COOKING AND SMOKER KIT

Il kit per la cottura indiretta è composto da una griglia rialzata in acciaio che permette di sollevare e quindi allontanare gli alimenti dalla fonte di calore. Con il kit da 500 mm è incluso anche il porta chips per legno aromatico, necessario se si desidera dare una nota affumicata alle proprie pietanze.

The indirect cooking kit is composed of a steel grid that can be raised to move the food away from the source of heat. The 500 mm kit also includes the container for aromatic wood chips, which is necessary if you wish to give your dishes a smoky taste.



KIT PANIFICAZIONE BAKING KIT

Il kit di panificazione permette di trasformare il BBQ a gas Fògher in un vero e proprio forno per cucinare pane, pizza o altri alimenti panificati. La particolare struttura con sistema di diffusione del calore e la superficie di cottura in cordierite permettono un'ottima trasmissione del calore consentendo di raggiungere temperature molto alte, fino a 350°C, eccellenti per cucinare pizza o pane.

The baking kit allows transforming the Fògher gas barbecue into a real oven to bake bread, pizza and other bakery products. The specific structure with a heat distribution system and the cordierite surface enable an ideal heat transfer, allowing the barbecue to reach very high temperatures, up to 350°C, which is the optimal temperature for baking pizza or bread.



ACCESSORI COTTURA

COOKING ACCESSORIES

SUPERFICI COTTURA DIRETTA-INDIRETTA | DIRECT-INDIRECT COOKING SURFACES

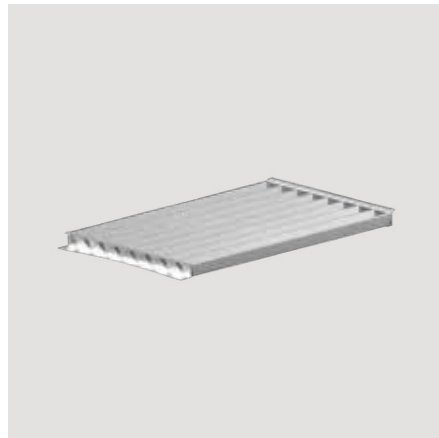

Griglia doppia in Acciaio inox FG
Stainless steel double grid FG

Misure (LxP) | Measures (WxD)
250 x 430 mm
Peso | Weight 2 kg

Cod. 1051116.0



Pietra ollare FG
Soapstone FG

Misure (LxP) | Measures (WxD)
250 x 430 mm
Peso | Weight 6,5 kg

Cod. 1059050.0

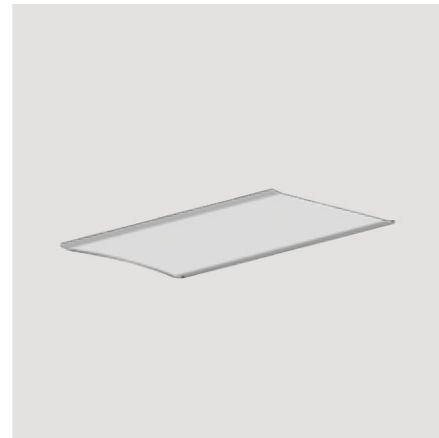

Fry top in acciaio Inox FG
Stainless steel fry top FG

Misure (LxP) | Measures (WxD)
250 x 430 mm
Peso | Weight 4 kg

Cod. 1068682.0

KIT PANIFICAZIONE | BAKING KIT



Kit pane e pizza barbecue 500*
Pizza/bread kit barbecue 500*

Misure (LxP) | Measures (WxD)
497 x 430 mm
Peso | Weight 7 kg

Cod. 1070730.0



Kit pane e pizza barbecue 750*
Pizza/bread kit barbecue 750*

Misure (LxP) | Measures (WxD)
743 x 430 mm
Peso | Weight 10 kg

Cod. 1070736.0



Kit pane e pizza barbecue 1000*
Pizza/bread kit barbecue 1000*

Misure (LxP) | Measures (WxD)
989 x 430 mm
Peso | Weight 13,5 kg

Cod. 1070740.0

KIT COTTURA INDIRETTA E AFFUMICATURA | INDIRECT COOKING AND SMOKING KIT



Kit cottura indiretta 250*
Indirect cooking kit 250*

Misure (LxP) | Measures (WxD)
250 x 430 mm
Peso | Weight 3 kg

Cod. 1070935.0



Kit cottura indiretta / affumicatura*
Indirect cooking / smoking kit*

Misure (LxP) | Measures (WxD)
500 x 430 mm
Peso | Weight 5,5 kg

Cod. 1070934.0

TEGLIE PANIFICAZIONE | BAKING TRAYS



Kit teglie pane
Baking trays kit

Misure (LxP) | Measures (WxD)
494 x 374 mm
Peso | Weight 3 kg

Cod. 1067263.0

* Compatibile solo con FGA-FO e FGB-FO
* Compatible only with FGA-FO and FGB-FO

TABELLA DI CONVERSIONE MODELLI E CERTIFICATI

MODELS AND CERTIFICATIONS CONVERSION CHART

MODELLI MODELS	CE (1)	CE PRO (2)	UL (3)
BARBECUE FGA 500	1072484.1	1072484.2	1072484.3
BARBECUE FGA 500 FO	1072485.1	1072485.2	1072485.3
BARBECUE FGA 750	1070463.1	1070463.2	1070463.3
BARBECUE FGA 750 FO	1070493.1	1070493.2	1070493.3
BARBECUE FGA 1000	1071440.1	1071440.2	1071440.3
BARBECUE FGA 1000 FO	1071742.1	1071742.2	1071742.3
BARBECUE FGB 250	1071584.1	1071584.2	1071584.3
BARBECUE FGB 500	1072502.1	1072502.2	1072502.3
BARBECUE FGB 500 FO	1072503.1	1072503.2	1072503.3
BARBECUE FGB 750	1070852.1	1070852.2	1070852.3
BARBECUE FGB 750 FO	1071761.1	1071761.2	1071761.3
BARBECUE FGB 1000	1072504.1	1072504.2	1072504.3
BARBECUE FGB 1000 FO	1071551.1	1071551.2	1071551.3
BARBECUE FGA 500 + GAMBE	1076476.1	1076476.2	1076476.3
BARBECUE FGA 750 + GAMBE	1076477.1	1076477.2	1076477.3
BARBECUE FGA 500 FO + GAMBE	1076478.1	1076478.2	1076478.3
BARBECUE FGA 750 FO + GAMBE	1076480.1	1076480.2	1076480.3
BARBECUE FGA 1000 FO + GAMBE	1076482.1	1076482.2	1076482.3
BARBECUE FGA 500 FO + CARRELLO CON 2 PIANETTI	1076479.1	1076479.2	1076479.3
BARBECUE FGA 750 FO + CARRELLO CON 2 PIANETTI	1076481.1	1076481.2	1076481.3
BARBECUE FGA 1000 FO + CARRELLO CON 2 PIANETTI	1076483.1	1076483.2	1076483.3

(1) CE = prodotti certificati per uso esterno rispondente alla normativa "EN 498 - UE 2016/426" (valido anche per il mercato UK).

(1) CE = products certified for outdoor use in compliance with the "EN 498 - EU 2016/426" standard (also valid for the UK market).

(2) PRO = prodotti certificati CE per uso professionale/interno rispondente alla normativa "EN 203-1-2014" (valido anche per il mercato UK).

(2) PRO = CE certified products for professional/indoor use in compliance with the "EN 203-1-2014" standard (also valid for the UK market).

(3) UL = prodotti certificati per USA e Canada rispondente alla normativa "Z21.58 2018 / CSA 1.6 2018".

(3) UL = certified products for USA and Canada in compliance with the regulation "Z21.58 2018 / CSA 1.6 2018".



L'ESPERIENZA DI BARBECUE DEFINITIVA

THE ULTIMATE BARBECUE EXPERIENCE

SMOKER

SMOKER

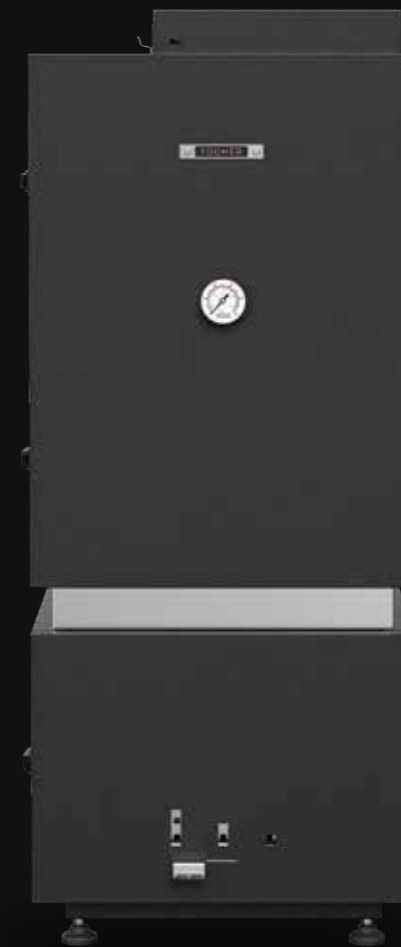

CUCINARE CON LO SMOKER A CARBONE

COOKING WITH THE COAL SMOKER

Uno smoker professionale disponibile in due versioni: water version o con reverse flow. Un cuore di acciaio altamente evoluto per una cucina speciale. È dotato di FIRE CORE®: un innovativo sistema in grado di schermare l'irradiazione termica proveniente dal carbone e di gestire il controllo dei fumi e del calore nella camera di cottura tramite le serrande superiori ed inferiori migliorando ancora di più la cottura dei vostri piatti.

A professional smoker, available in two different versions: water version or with reverse flow. A highly advanced steel core for a distinctive kitchen. It is provided with FIRE CORE®, an innovative system capable of shielding coal thermal propagation and handling fumes and heat in the cooking chamber through upper and lower airways that will enhance your cooking experience.



METODO DI COTTURA LOW & SLOW

LOW & SLOW COOKING METHOD

Il metodo di cottura Low & Slow consiste in una cottura prolungata di diverse ore a temperature basse. Questo metodo di cottura è tipico degli affumicatori che anche grazie all'aggiunta del fumo donano agli alimenti preparati una consistenza morbida e delicata ma soprattutto una nota aromatica molto decisa e intensa.

"Low & Slow" is a culinary technique consisting in a long slow cooking at very low temperatures. It is typically carried out with smokers, where fumes give the food a tender and delicate consistency, while releasing a very distinctive and intense aroma.

ESEMPI DI PREPARAZIONI | EXAMPLES OF PREPARATIONS



ROAST BEEF | ROAST BEEF

Temperatura smoker | Smoker temperature
225-250°F - 107-121°C

Tempo di cottura | Cooking time
30 min / 1 kg

Temperatura interna | Internal temperature
135°F - 57°C



PULLED PORK | PULLED PORK

Temperatura smoker | Smoker temperature
225-250°F - 107-121°C

Tempo di cottura | Cooking time
4 hr / 1 kg

Temperatura interna | Internal temperature
205°F - 96°C



COSTA DI MAIALE | PORK CHOPS

Temperatura smoker | Smoker temperature
225-250°F - 107-121°C

Tempo di cottura | Cooking time
3 hr / 1 kg

Temperatura interna | Internal temperature
160°F - 71°C

LO SMOKER IN DETTAGLIO

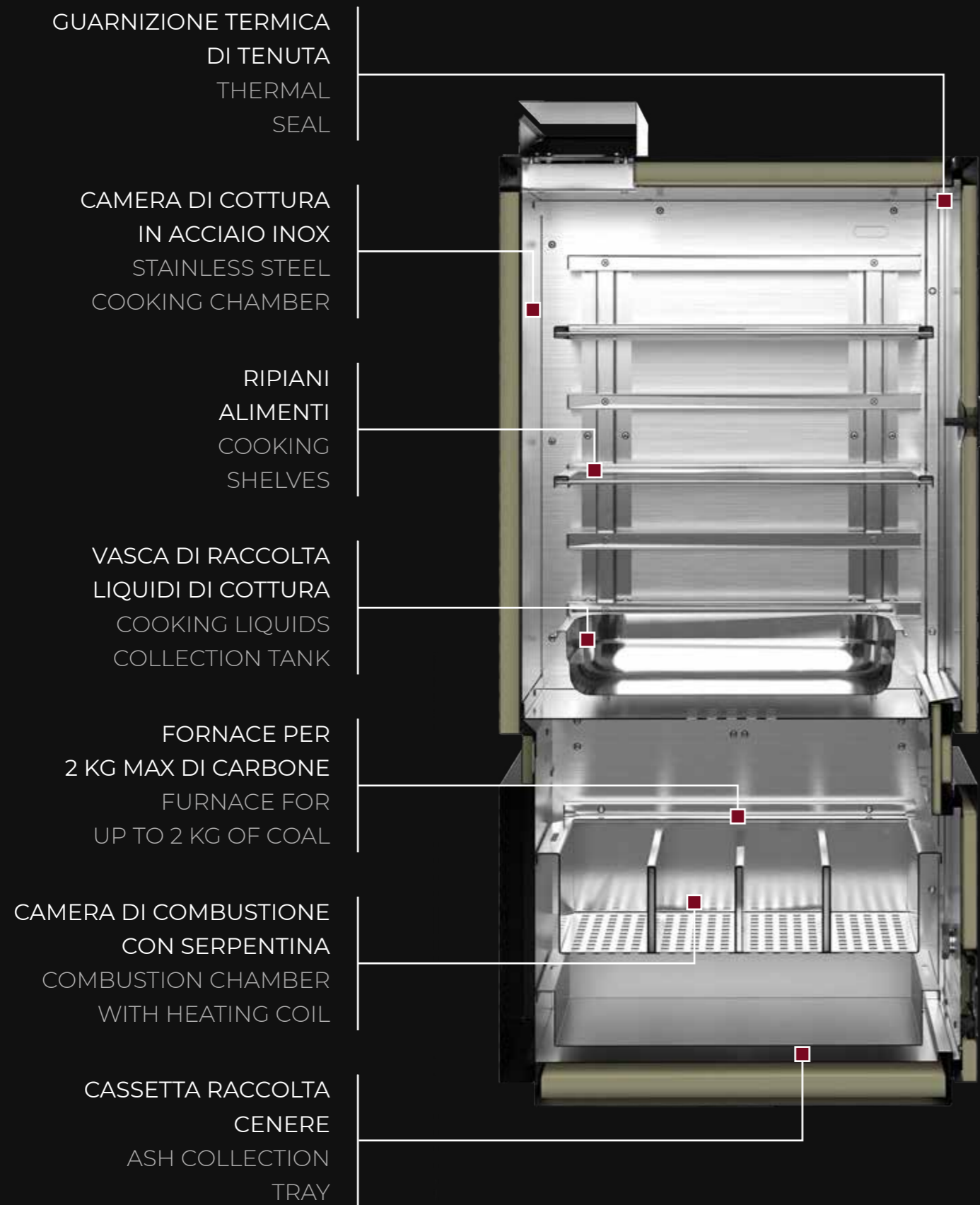

THE SMOKER IN DETAIL

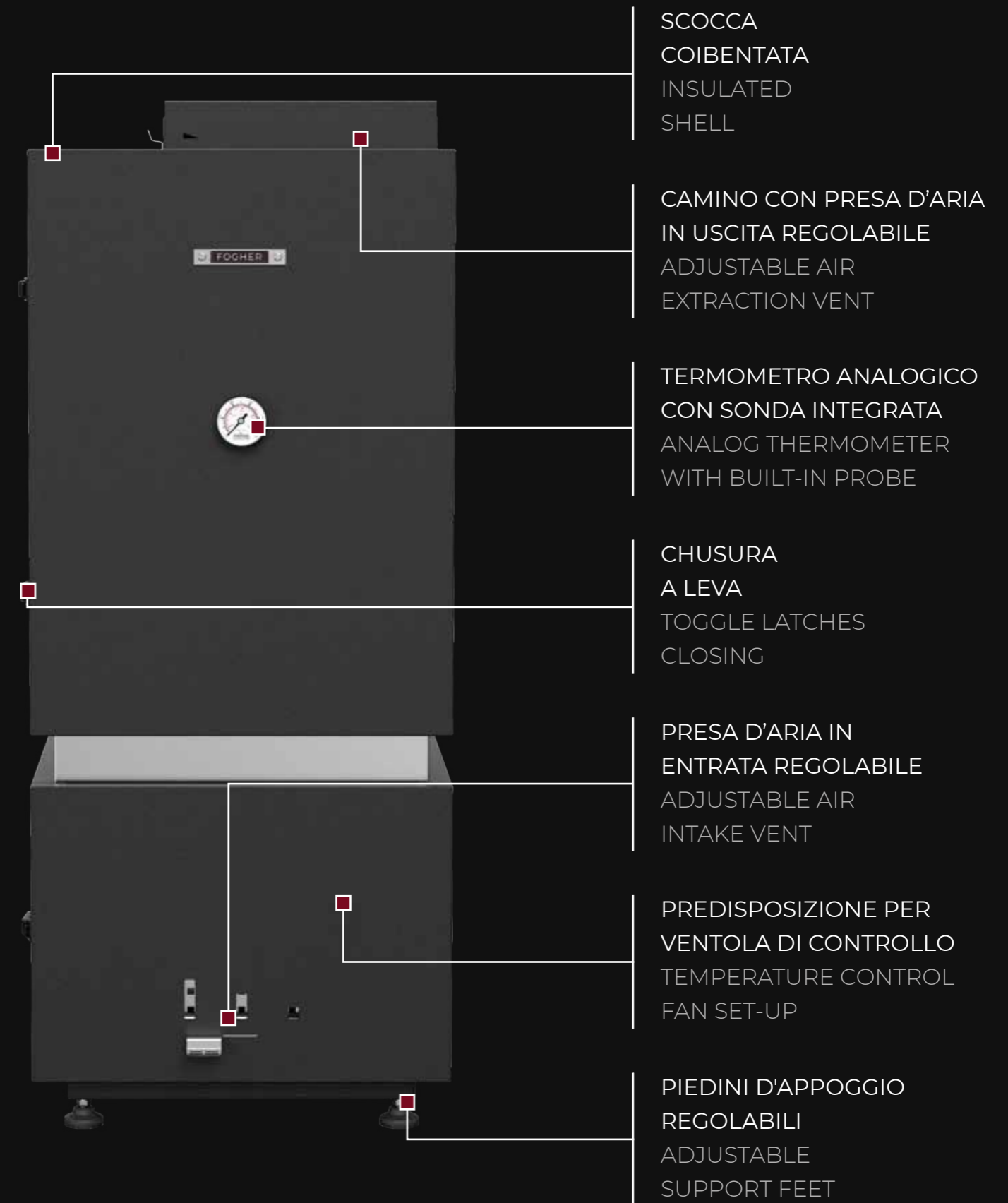

DETTAGLI TECNICI

Lo step successivo per ogni amante del barbecue. Grazie allo smoker Fògher infatti non ci saranno più limiti alla preparazione dei tuoi piatti a cottura lenta. Il nostro smoker permette di ottenere risultati professionali con una estrema semplicità di utilizzo, tutti i componenti sono stati studiati per avere un controllo completo su temperatura, affumicatura e cottura rendendo l'esperienza di cucinare con lo smoker un gioco da ragazzi.



CAMINO CON PRESA D'ARIA IN USCITA REGOLABILE ADJUSTABLE AIR EXTRACTION VENT

Grazie alle prese d'aria con saracinesca regolabile è possibile controllare con estrema precisione la quantità di aria e di fumo presenti nella camera di combustione e di cottura.

The airways with adjustable air extraction vents will help you monitor with extreme accuracy the quantity of air and smoke in the combustion and cooking chamber.



PRESA D'ARIA IN ENTRATA REGOLABILE ADJUSTABLE AIR INTAKE VENT

La presa d'aria inferiore è adibita a far entrare l'aria all'interno della camera di combustione per alimentare le braci e quindi aumentare o diminuire il calore generato nello smoker. Anche in questo caso vi è la possibilità di regolare con precisione il flusso d'aria grazie ad una pratica saracinesca.

The lower airway has been conceived to let the air enter the combustion chamber, in order to feed the embers, and consequently increase or decrease the heat in the smoker. In this case as well you have the possibility to precisely control the airflow through the vent.

TECHNICAL DETAILS

The next step for bbq lovers. Thanks to Fògher smokers there will be no more limits to your slow cooked dishes. Our smokers guarantee professional results and ease of use. Each component has been conceived to ensure total control of temperature, smoking and cooking, making the cooking experience enjoyable also for non-professionals.



CAMERA DI COTTURA IN ACCIAIO INOX STAINLESS STEEL COOKING CHAMBER

La camera di cottura è realizzata in acciaio inossidabile per garantire un'eccellente qualità costruttiva, oltre a ciò non vi è il rischio di contaminare i cibi ed è alquanto semplice mantenerla pulita e igienizzata.

The stainless-steel cooking chamber ensures excellent build quality and the non-contamination of food. Moreover, it is very easy to clean and sanitize.



SCOCCA COIBENTATA INSULATED SHELL

La scocca coibentata consente di isolare e diffondere il calore in maniera equa all'interno della camera di cottura migliorando la cottura ed evitando quindi un consumo eccessivo di carbone.

The insulated shell will help you isolate and spread the heat evenly in the cooking chamber to improve the quality of cooking and consequently avoid excessive coal consumption.

L'isolamento di alta qualità e il movimento controllato dell'aria all'interno dello smoker assicurano una stabilità della temperatura in tutta la camera. Siamo riusciti a ridurre il consumo di carbone del 50% rispetto ad uno smoker tradizionale a carbone.

High-quality insulation and air control in the smoker guarantee temperature stability in the whole cooking chamber. We have managed to reduce coal consumption up to 50% compared to a traditional charcoal smoker.



CAMERA DI COMBUSTIONE CON SERPENTINA COMBUSTION CHAMBER WITH HEATING COIL

La camera di combustione è dove vengono generati il calore e il fumo necessari a cucinare gli alimenti. Grazie alla serpentina integrata nella camera di combustione è possibile ottenere una maggiore efficienza energetica senza compromessi in termini di prestazioni.

The heat and smoke you need to cook are generated directly in the combustion chamber. The heating coil integrated in the combustion chamber will help you gain greater energy efficiency without any compromise in terms of performance.

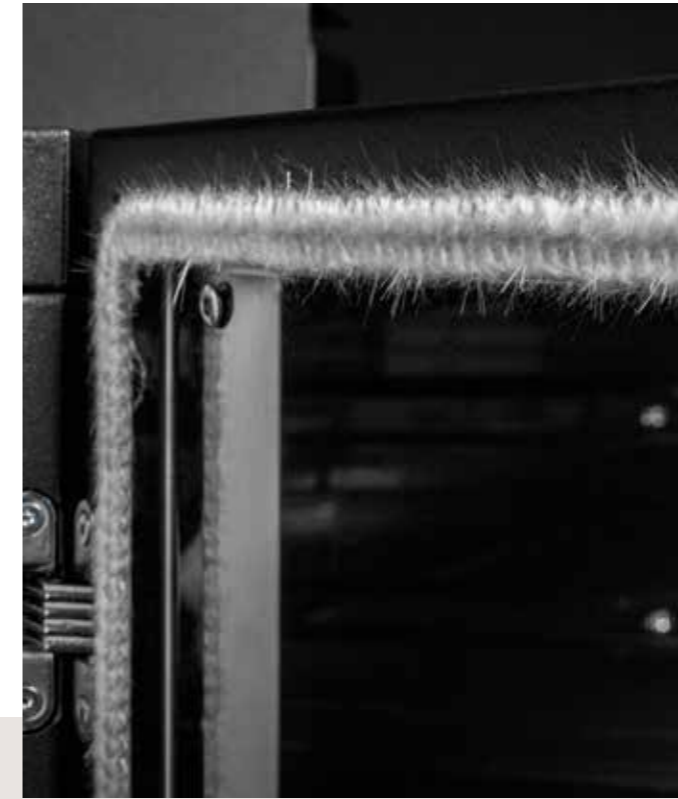

GUARNIZIONE TERMICA DI TENUTA THERMAL SEAL

La guarnizione di tenuta termica dello smoker Fògher consente di trattenere il calore all'interno della camera di cottura per una maggiore stabilità delle temperature durante il processo di cottura.

The high-temperature resistant gasket of Fògher smokers avoids the heat to come out from the cooking chamber, ensuring stable temperatures while cooking.



VASCA DI RACCOLTA LIQUIDI DI COTTURA COOKING LIQUIDS COLLECTION TANK

Attraverso il nostro sistema di raccolta dei liquidi di cottura non sarà più necessario preoccuparsi dello sporco, infatti in ogni smoker Fògher è presente un pratico contenitore asportabile per la raccolta dei liquidi di colatura. In alternativa è possibile il montaggio di uno scarico per la raccolta direttamente negli appositi contenitori.

Thanks to our system of collection of the cooking liquids you no longer have to worry about dirt. Each Fògher smoker includes a functional extractable tray to collect dripping cooking liquids. In alternative, an exhaust system is available to collect the liquids directly and to transfer them into specific containers.



RIPIANI ALIMENTI COOKING SHELVES

Lo smoker Fògher consente l'installazione di fino a sei ripiani per alimenti all'interno della camera di cottura. Tutti gli spazi sono compatibili con accessori Gastro Norm 2/3, il prodotto viene fornito con due griglie in acciaio inossidabile alimentare AISI 304.

Fògher smokers have been conceived for the installation of Gastro Norm 2/3 accessories. Up to six cooking shelves can be installed in the cooking chamber. The smokers all come with two AISI 304 stainless-steel grills.

Una cucina professionale non può lasciare spazio agli imprevisti. È per questo che lo smoker a carbone professionale Fògher controlla la temperatura interna per mezzo di un doppio termometro analogico, oltre alla predisposizione di serie per l'inserimento di sonde di controllo. Non resta che goderti il piacere di cucinare.

There's no room for unforeseen events in a professional kitchen. That's why Fògher professional charcoal smokers check the internal temperature thanks to a double thermometer, granting the possibility to include thermal sensors. All you have to do is enjoy the pleasure of cooking.

TERMOMETRO ANALOGICO CON SONDA INTEGRATA ANALOG THERMOMETER WITH BUILT-IN PROBE

Grazie al termometro analogico con sonda integrata all'interno della camera di cottura è possibile tenere sempre sotto controllo, in maniera precisa, la temperatura durante tutto il processo di cottura. Se il termometro analogico integrato non dovesse bastare sono state previste delle predisposizioni per sonde esterne.

The analog thermometer with built-in probe will help you precisely check the temperature during the cooking process. In addition to the analog thermometer, there is the possibility to use external temperature probes.

CHIUSURA A LEVA TOGGLE LATCHES CLOSING

Sicura ma allo stesso tempo semplice e comoda da utilizzare, la chiusura a leva è un componente fondamentale in ogni smoker Fògher.

Safe and easy to use. Toggle latches closure is a fundamental element in each Fògher smoker.

CASSETTA RACCOLTA CENERE TRAY FOR ASH COLLECTION

La pratica cassetta di raccolta della cenere permette di avere un smoker facile da pulire e che non sporca l'ambiente circostante di polveri e particelle derivanti dalla combustione.

The functional tray for ash collection will help you keep the smoker clean, while avoiding the surrounding spaces to be soiled by ashes or particles caused by combustion.

PIEDINI D'APPOGGIO REGOLABILI ADJUSTABLE SUPPORT FEET

I piedini d'appoggio regolabili aiutano la stabilità dello smoker consentendo un posizionamento anche su terreni non perfettamente uniformi come erba o roccia.

Adjustable support feet ensure smoker stability, also when the machine is placed on uneven surfaces such as grass or rocks.



Abbiamo deciso di realizzare il migliore smoker a carbone esistente, che potesse dare ai cibi l'aroma dell'affumicatura, senza danneggiarne le qualità. Questo, grazie al passaggio laterale che convoglia i fumi e bilancia la loro distribuzione nella camera di cottura.

We wanted to create the best available charcoal smoker, that would give your dishes a smoked aroma, without compromising the quality of food. This is made possible by the lateral airway conveying the smoke and spreading it evenly in the cooking chamber.

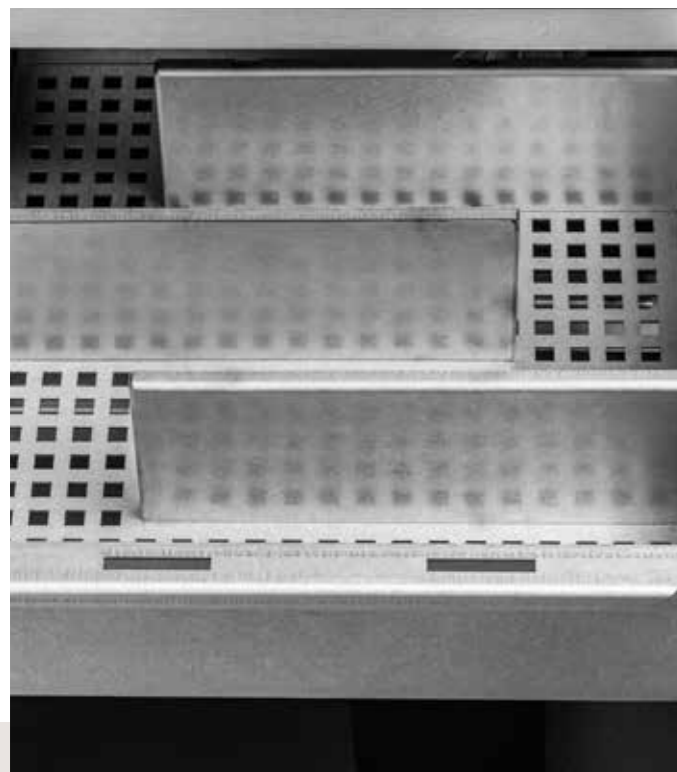

FORNACE PER 2 KG MAX DI CARBONE FURNACE FOR UP TO 2 KG OF COAL

La fornace dello smoker Fògher può contenere fino a 2kg di carbone permettendo quindi cotture molto lunghe senza necessità di rifornimenti.

Fògher smokers furnace can contain up to 2 kg of charcoal, allowing very slow cooking with no requirement of additional supply.



PREDISPOSIZIONE PER VENTOLA DI CONTROLLO TEMPERATURE CONTROL FAN SET-UP

Tutti i nostri affumicatori hanno la predisposizione per l'installazione di una ventola di controllo automatico del calore, questo sistema regola il flusso di aria che entra nella camera di combustione e che regola quindi la temperatura a cui vengono cotti gli alimenti.

Each of our smokers comes with a temperature control fan set-up. In this way the airflow entering the combustion chamber is better controlled and the cooking temperature is regulated.





AFFUMICATURA 80-120°C
SMOKING 80-120°C

SMOKER WS E RF

WS AND RF SMOKER

L'irraggiamento costante all'interno dello smoker a carbone fa sì che la carbonella distribuisca il calore in modo rapido e uniforme, conferendo al piatto una consistenza sostanziale e se utilizzato con legni specifici doni profumi unici per ogni ricetta. La qualità della costruzione innovativa dello smoker Fögher ci permette di portare uno smoker professionale a servizio di qualsiasi cliente. L'interno della camera in acciaio Inox e le griglie regolabili garantiscono facilità di pulizia e di manutenzione.

The charcoal in the smoker ensures that the heat is spread rapidly and evenly, giving the food a significant consistency. Using specific wood, you will give your dishes unique fragrances.

The build quality of Fögher smokers makes it possible to use them for any kind of user. The stainless-steel cooking chamber and adjustable grills make them easy to clean and maintain.



WS 450

Smoker water version

WS 450

Water version smoker

Misure (LxP) | Measures (WxD)

434 x 503 mm

Peso | Weight 56 kg

Cod. 1062131.0



RF 450

Smoker con kit reverse-flow

RF 450

Built-in reverse-flow kit smoker

Misure (LxP) | Measures (WxD)

434 x 503 mm

Peso | Weight 62 kg

Cod. 1075715.0

ACCESSORI SMOKER

SMOKER ACCESSORIES

ACCESSORI | ACCESSORIES



Accessorio reverse flow (solo per Cod. 1062131)

Reverse flow accessory
(Only for Cod. 1062131)

Peso | Weight 5,5 kg

Cod. 1043541.0



Set 2 griglie smoker

2 grids set for smoker

Misure (LxP) | Measures (WxD)
380 x 321 mm

Peso | Weight 2,5 kg

Cod. 1064019.0



Pianetto laterale smoker

Smoker side shelf

Misure (LxP) | Measures (WxD)
225 x 483 mm

Peso | Weight 3 kg

Cod. 1063995.0

ACCESSORI | ACCESSORIES

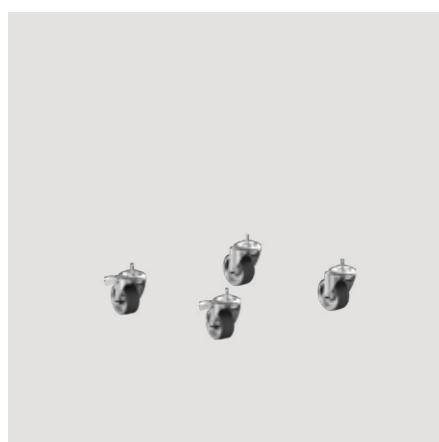

Kit ruote smoker

Smoker wheels kit

Peso | Weight 1 kg

Cod. 1059177.0

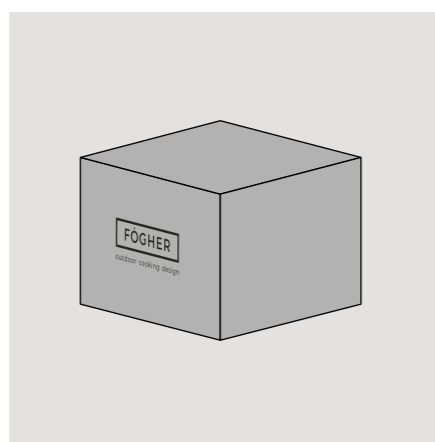

Copertura in tessuto

Textile cover

Cod. 1077323.0

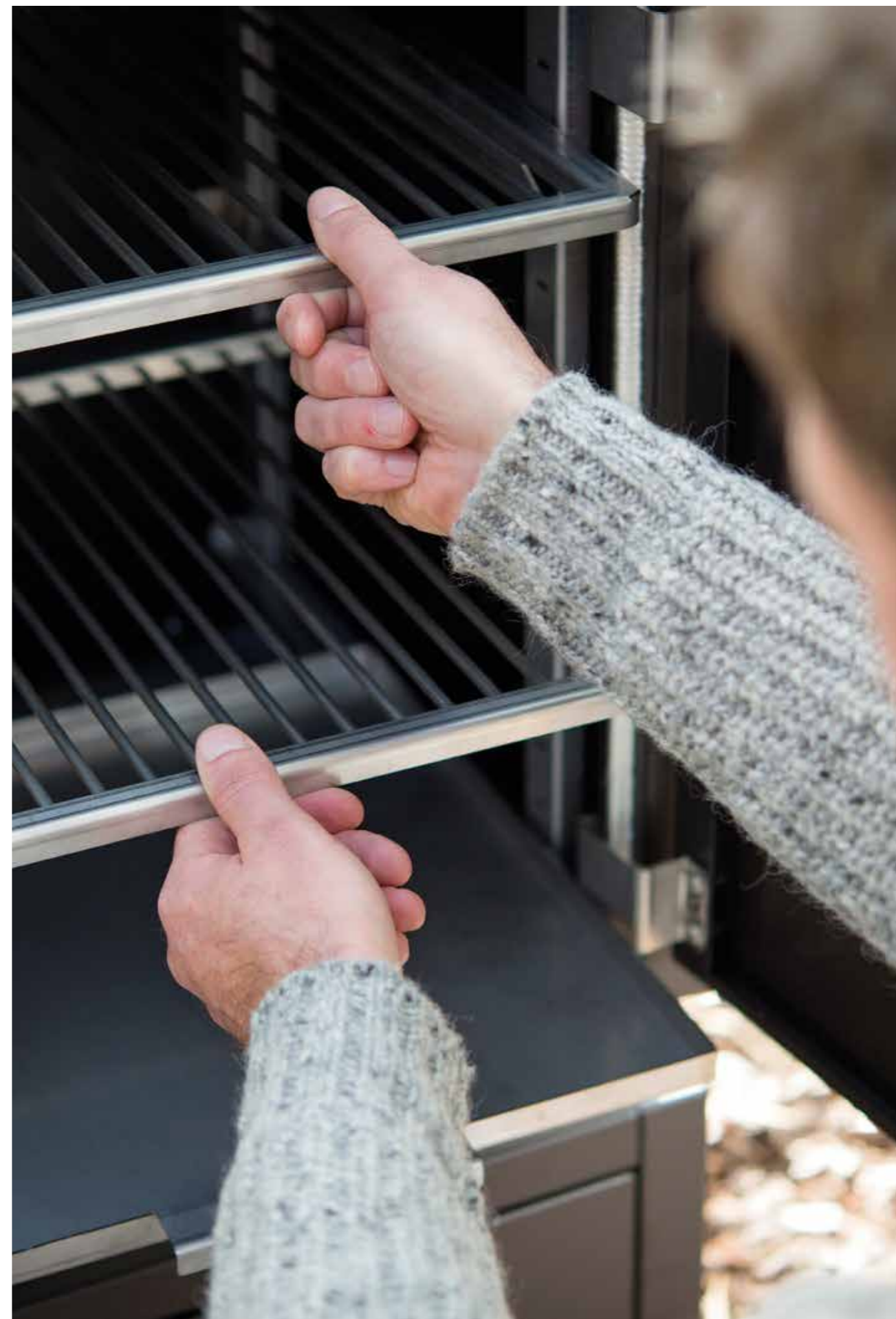



OSA, SPERIMENTA, CREA
DARE, EXPERIMENT, CREATE

CAMINETTO GRILL

OUTDOOR FIREPLACE



TECNOLOGIA E DESIGN

TECHNOLOGY AND DESIGN

Il caminetto grill da giardino è lo strumento perfetto per adattarsi a qualsiasi tipo di spazio esterno. È ottimo per preparare pietanze con le tipiche modalità di cucina alla griglia italiana: l'Italian Style Grill. I sapori e le fragranze del cibo sono esaltate dalla cottura su braci, che vengono prodotte in modo naturale direttamente dalla legna, utilizzata come combustibile. In alternativa è possibile utilizzare anche carbone e bricchette.

The outdoor fireplace with grill is suitable for any outdoor space. It has been conceived to prepare dishes according to the typical Italian way of grilling: Italian Style Grill. The flavors and fragrances of food are enhanced by the embers, produced naturally directly from wood, which is used as fuel. Charcoal or briquettes can be used as well.

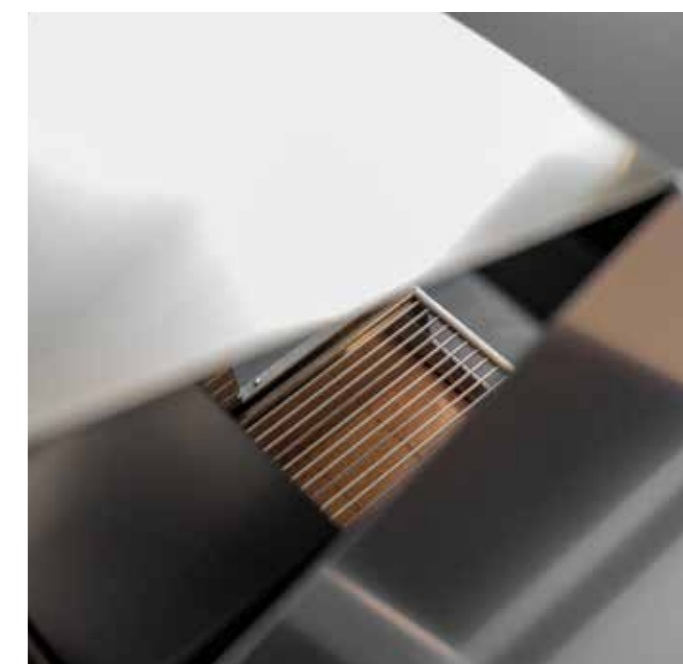

IL CAMINETTO IN DETTAGLIO

THE FIREPLACE IN DETAIL

DOPPIA CAPPA PER EVITARE
IL SURRISCALDAMENTO
DOUBLE HOOD TO AVOID
SURFACE OVERHEATING

CANALINA DI SCOLO PER
LE ACQUE PIOVANE
DRAIN CHANNEL
FOR RAINWATER

RIVESTIMENTO INTERNO IN
MATTONI REFRAATTARI
INTERNAL COATING IN
REFRACTORY BRICKS

VERNICE RESISTENTE
ALLE INTEMPERIE
BAD WEATHER RESISTANT
EXTERNAL PAINT

GRIGLIA DI COTTURA A
TONDINI IN ACCIAIO INOX
STAINLESS STEEL
COOKING GRID

SCocca IN
ZINCO MAGNESIO
ZINC MAGNESIUM
SHELL

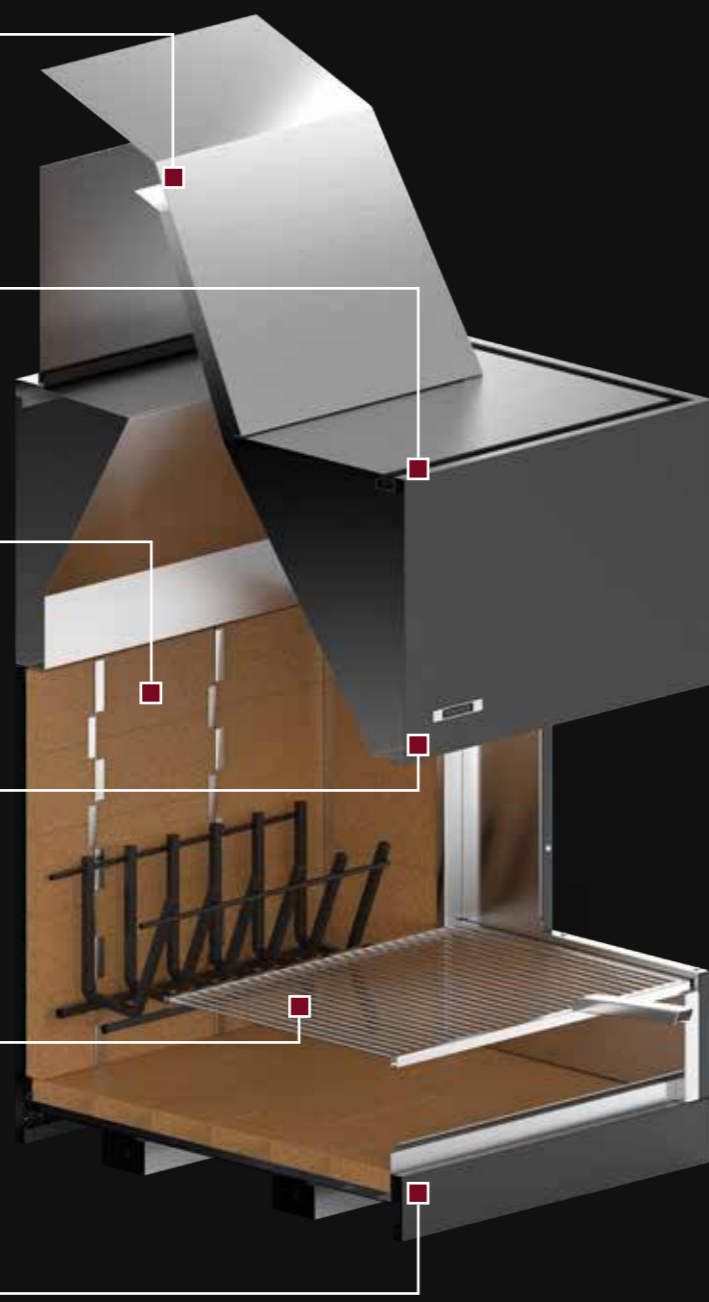

DETTAGLI TECNICI

Il nuovo caminetto da giardino Fògher è stato ridisegnato per fare un ulteriore passo avanti sia in termini tecnici che di stile. Ogni elemento è stato progettato nei minimi dettagli, senza lasciare nulla al caso, dalla cappa d'aspirazione, al pianetto d'appoggio. Tutto è pensato per rispondere al meglio alle esigenze dei clienti, rendendolo uno strumento altamente professionale, pensato appositamente anche per gli esperti del settore.



DOPPIA CAPPA PER EVITARE IL SURRISCALDAMENTO DOUBLE HOOD TO AVOID SURFACE OVERHEATING

Gli studi di fluidodinamica che stanno alla base della progettazione della cappa hanno permesso la realizzazione di un elemento in grado di garantire la massima efficienza di aspirazione in qualsiasi condizione atmosferica. La cappa inoltre è dotata di una camera d'aria ventilata necessaria alla dissipazione del calore prodotto internamente, consentendo di preservare nel tempo le caratteristiche estetiche e di resistenza della superficie esterna.

The fluid-dynamics researches at the basis of the design of the hood allowed the creation of a product capable of guaranteeing the maximum efficiency of aspiration in any condition. The hood is also equipped with a ventilated air chamber necessary to dissipate the heat that is produced internally, to preserve the aesthetics and resistance of the external surfaces over time.



CANALINA DI SCOLO PER LE ACQUE PIOVANE DRAIN CHANNEL FOR RAINWATER

L'eccellenza di un prodotto esclusivo trova riscontro anche nei dettagli, come la canalina di scolo delle acque piovane, presente nella cappa, per proteggere la zona di cottura dalle intemperie.

The excellence of an exclusive product is also found in detail, such as the channel to drain rainwater, placed inside of the hood, to preserve the cooking area from bad weather conditions.

TECHNICAL DETAILS

Fògher outdoor fireplace has been recently redesigned and has taken a further step forward in terms of technical features and style. Each element has been created with attention to details, that leaves nothing to chance, from the extractor hood to the support surface. Everything has been designed to better meet clients' demands, making the fireplace a highly professional tool, also conceived for connoisseurs.



RIVESTIMENTO INTERNO IN MATTONI REFRATTARI INTERNAL COATING IN REFRACTORY BRICKS

Il caminetto grill da giardino prevede l'impiego di mattoni refrattari sul piano cottura a contatto con il fuoco, che trasferiscono alla struttura le caratteristiche di indeformabilità al calore e mantenimento stabile della temperatura di esercizio. Facili da sostituire, sono assemblati con giunti di dilatazione che evitano crepe e rotture.

The outdoor fireplace with grill is equipped with refractory bricks, placed on the cooking surface into direct contact with fire. They grant the structure features such as non-deformability when exposed to heat and stable temperature maintenance. Bricks are easily replaceable and assembled with expansion joints to avoid cracks and fractures.



GRIGLIA COTTURA A TONDINI IN ACCIAIO INOX STAINLESS STEEL COOKING GRID

Fornita insieme al caminetto grill da giardino Fògher, la griglia a tondini è realizzata interamente in acciaio inossidabile, resistente al calore e non corrodibile garantisce risultati ottimi anche dopo molto tempo.

A stainless-steel cooking grid is provided in addition to the outdoor fireplace. Heat resistant and non-corrodible, the grid ensures excellent results over time.

“I sapori e le fragranze del cibo sono esaltati dalla cottura su braci, che vengono prodotte in modo naturale direttamente dalla legna, utilizzata come combustibile”.

“Flavors and fragrances are enhanced by the embers, produced naturally directly from wood, which is used as fuel”.

VERNICIATURA RESISTENTE ALLE INTEMPERIE BAD WEATHER RESISTANT EXTERNAL PAINT

La speciale verniciatura a polveri della superficie esterna, combinata al materiale della scocca di spessore elevato, garantisce una ottimale resistenza agli agenti atmosferici e rende il caminetto Fògher un prodotto pensato per conservare prestazioni immutate nel tempo.

The special powder coating of the external surfaces, together with the thickness of the materials that compose the body, guarantees an ideal resistance to any weather condition, and makes Fògher's fireplace a product specifically designed to preserve its performances over time.

SCOCCA IN ZINCO MAGNESIO ZINC MAGNESIUM SHELL

La lega metallica che compone la scocca del caminetto, grazie all'utilizzo di metalli come lo zinco e il magnesio, permette di ottenere un'eccezionale robustezza e resistenza all'usura.

The metal alloy used for the fireplace shell, made of zinc magnesium, makes it possible to have extraordinary strength and wear resistance.





CAMINETTO PER COTTURA DIRETTA
FIREPLACE FOR DIRECT COOKING

CAMINETTO GRILL FFP 950

FFP 950 FIREPLACE

Fògher offre ai suoi clienti un prodotto dalle molteplici funzionalità e pratico da utilizzare, leggero e facile da riposizionare. Il caminetto grill da giardino si compone di diversi elementi ed è perfettamente integrabile anche al sistema di cucina modulare. L'esperienza e la qualità 100% Made in Italy sono messe in evidenza dall'aspetto professionale e dalle finiture contemporanee. Le linee pulite e lo stile geometrico conferiscono un design elegante e moderno.

Fògher proposes to its customers a user-friendly product with multiple functions, light and easy to move. The outdoor fireplace with grill is composed by diverse elements and it can also be perfectly integrated into the modular kitchen system. The 100% Made in Italy know-how and quality are enhanced by the professional appearance and the contemporary finishes. The clean lines and the geometric style give the product an elegant and modern design.



Caminetto grill FFP 950

FFP 950 fireplace

Misure (LxP) | Measures (WxD)

950 x 715 mm

Peso | Weight 162 kg

Cod. 1077329.0

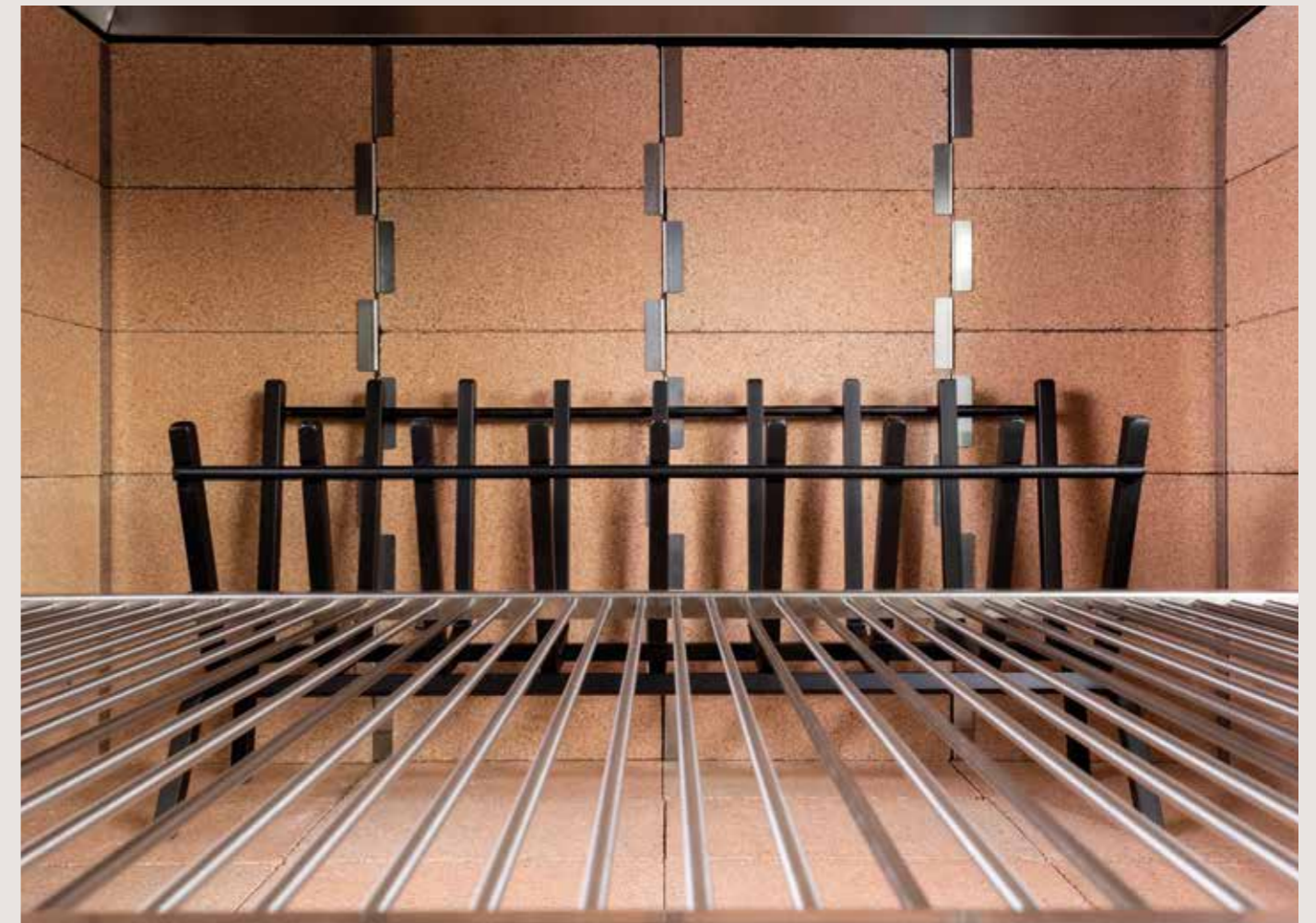

COMPOSIZIONI PREDEFINITE

CAMINETTO GRILL FFP 950

FFP 950 OUTDOOR FIREPLACE

STANDARD CONFIGURATIONS



SOLUZIONI | SOLUTIONS



Caminetto grill FFP 950 con gambe tubolari FKS 010

FFP 950 fireplace with tubular legs FKS 010

Misure (LxP) | Measures (WxD): 950 x 715 mm

Peso | Weight 192 kg

Cod. 1077324.0



Caminetto grill FFP 950 con carrello FKS 009

FFP 950 fireplace with cart FKS 009

Misure (LxP) | Measures (WxD): 1235 x 750 mm

Peso | Weight 230 kg

Cod. 1076484.0



Caminetto grill FFP 950 con gambe tubolari e carenature FKS 011

FFP 950 fireplace with tubular legs and doors FKS 011

Misure (LxP) | Measures (WxD): 1051 x 590 mm

Peso | Weight 206 kg

Cod. 1077325.0

ACCESSORI CAMINETTO

FIREPLACE ACCESSORIES

ACCESSORI | ACCESSORIES



Carrello caminetto FFP 950
950 fireplace cart

Misure (LxP) | Measures (WxD)
1210 x 890 mm
Peso | Weight 49 kg

Cod. 1074609.0



Supporto caminetto FFP 950
950 fireplace support

Misure (LxP) | Measures (WxD)
915 x 665 mm
Peso | Weight 30 kg

Cod. 1074639.0



Carenature caminetto FFP 950
FFP 950 fireplace doors

Peso | Weight 14 kg

Cod. 1074644.0

ACCESSORI | ACCESSORIES



Ripiano intermedio carrello FFP 950
Middle shelf for FFP 950 cart

Misure (LxP) | Measures (WxD)
945 x 675 mm
Peso | Weight 10 kg

Cod. 1074618.0

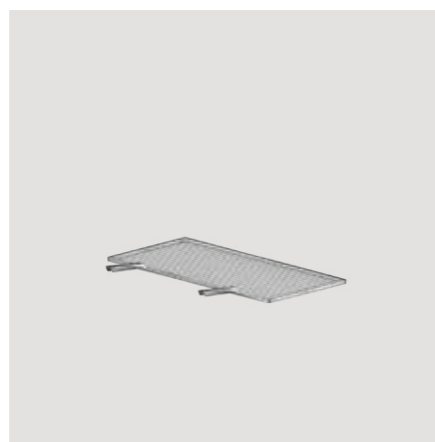

Griglia di cottura Inox FFP
Stainless steel FFP grill

Misure (LxP) | Measures (WxD)
900 x 430 mm
Peso | Weight 5 kg

Cod. 1074718.0

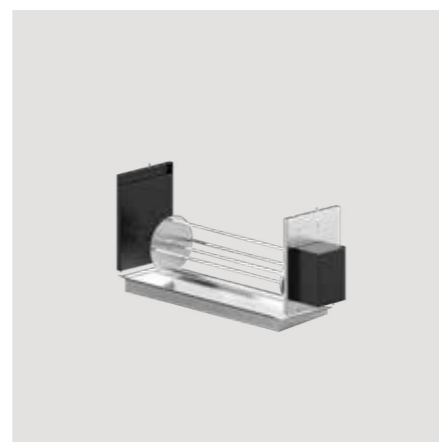

Girarrosto elettrico in acciaio
Electric steel rotisserie

Misure (LxP) | Measures (WxD)
830 x 395 mm
Peso | Weight 15 kg

Cod. 1075745.1



* Il codice di vendita indicato è relativo alla certificazione CE dei sistemi di cottura.

* The indicated sales code relates to the CE certification of the cooking systems.

MADE IN ITALY



LA NOSTRA AZIENDA

Fògher è un marchio che nasce da un nostro grande desiderio: dare vita ad oggetti che abbiano la capacità di appassionare chi li utilizza, non solo per l'estetica, ma anche per la qualità professionale dei risultati che essi permettono di raggiungere. Alle spalle, esiste un'azienda specializzata nella lavorazione del metallo. Deimos, la nostra azienda, che da più di 25 anni lavora in questo settore, realizza prodotti e progetti complessi eseguiti da chi, come noi, può vantare esperienza e grandi capacità tecniche.



OUR COMPANY

Fògher comes out from our desire to create objects capable of fascinating the users, not only because of the aesthetics, but also for the professionalism of the results they allow to achieve. Fògher leans on our company Deimos, that has been operating for more than 25 years in the field of metal processing, creating complex products and projects that can be realized only thanks to experience and great technical abilities.



PRODOTTI SPECIALI, REALIZZATI IN MODO SPECIALE SPECIAL PRODUCTS, REALIZED IN A SPECIAL WAY

Produciamo oggetti che fanno riscoprire la serenità di vivere all'aria aperta e il piacere della condivisione tra amici e parenti. In questi momenti vogliamo poter realizzare qualsiasi pietanza senza limitazioni ai nostri desideri.

We produce objects which make people rediscover the serenity of outdoor life and the pleasure of sharing with friends and family. In such times we want the freedom to be able to create whatever dish we wish to realize.





Deimos srl

Via Cavassico Inferiore, 1
Località Trichiana
32026, Borgo Valbelluna (BL) - ITALY

tel. (+39) 0437 8066 - fax. (+39) 0437 806699
www.deimosgroup.it - info@deimosgroup.com
P.IVA e C.F. 00847230257

www.fogher.com - info@fogher.com

FÒGHER

is a trademark Deimos 2022 ©, DEIMOS srl All rights reserved.

PRODUCT DESIGN - ART DIRECTION - GRAPHIC DESIGN:
Anidride Design - Arch. Nicola De Pellegrini

PRINT:
Grafiche Antiga Spa

CAE20.04.0089

FÒGHER
outdoor cooking design

www.fogher.com